

General Catalog of Pneumatic/ Fluid Transport Tube, Tube Fitting and CHEMIFIT®

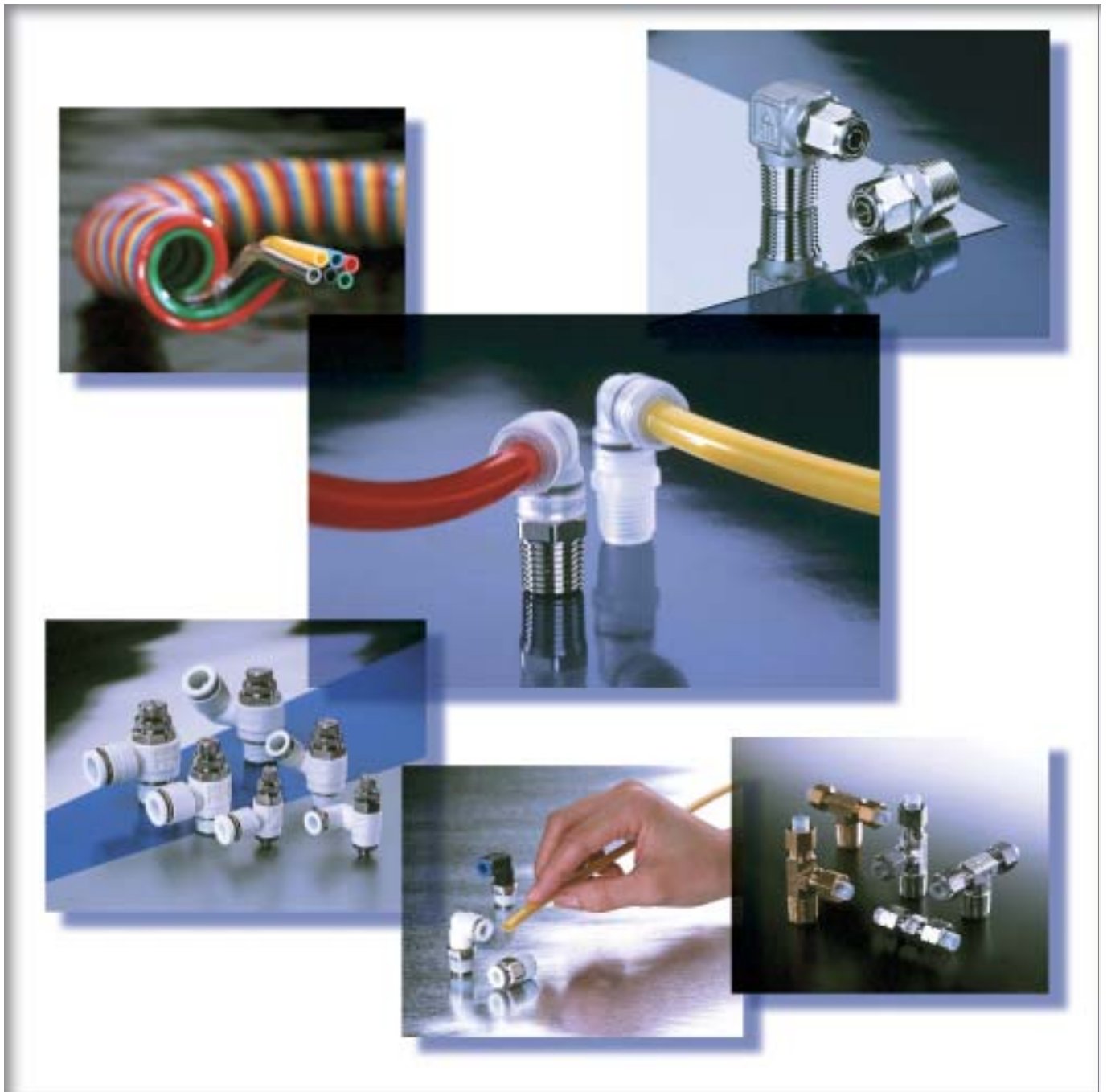

B-TU-10E



Common handling instructions for products in catalog

Safety Note

This Safety Note provides indications on the correct use of the product in order to prevent harm to people and property. The indications are classified into three categories, “danger”, “warning”, and “caution”, depending on the level of potential harm due to improper use. Each category contains important instructions on safety that should be followed in addition to the latest ISO 4414(*1), JIS B 8370(*2), ISO4413 (*3), and JIS B 8361 (*4).

*1 ISO4414 Pneumatic fluid power...Recommendations for the application of equipment to transmission and control systems.

*2 JIS B 8370 Pneumatic System General Rules

*3 ISO4413 Hydraulic fluid power...General rules for the application of equipment to transmission and control systems.

*4 JIS B 8361 Hydraulic System General Rules

DANGER

Where inappropriate use of this equipment may cause death or severe injury and where immediate warning of a dangerous situation is highly required.



WARNING

Where inappropriate use of this equipment may cause death or severe injury.



CAUTION

Where inappropriate use of this equipment may cause minor injury.

For more safety please read the handling instructions carefully. A safety note for each product is also given on its product page and instruction page.

Exclusion of Liability

- ① Nitta Company is not liable for damage caused intentionally and unintentionally by customers, damage due to products other than Nitta's including software failure, and damage due to natural disasters.
- ② Nitta Company is not liable for damage due to usage that is not explained or specified in this catalog and instruction manual.
- ③ Nitta Company is not liable for damage without any clear record of its liability even if the damage occurred after the customer contacts Nitta .
- ④ Nitta Company is not liable for collateral damage such as loss of business income and business termination due to using Nitta's products or due to inability to use our products.

* Specifications in this catalog are subject to change without notice.

* Secondary use of information in this catalog for copy, diversion and sale without permission is prohibited.

INDEX

Common handling instructions

Index: Index of All Products **P.2**

Combination List of Tube and Fitting (Working temperature range) **P.8**

Tube Products **P.10**

Handling instructions INDEX

Tube

Polyurethane tube/Nylon tube
Flexible fluorocarbon resin bilayer tube/Flame-resistant tube/Antistatic tube
Shape-keeping tube/Polybutene tube

Clean Tube

Polyolefin tube/Fluorocarbon resin tube

Processed Tube

Polyurethane coil tube/Polyurethane multi-line tube/Nylon coil tube/Multi-pack tube

Tube Fitting Products **P.34**

Handling instructions INDEX

PushOne series

PushOne A series/PushOne E series
PushOne E series (mini type)/PushOne E series (brass body type)
PushOne E series (electroless nickel plated type)

QuickSeal series

Insertion type (brass)/Insertion type (stainless)/Insertless type
DK tube dedicated type/Nylon coil tube dedicated type

Chemifit series

Chemifit C1 series/Chemifit C1S series
Chemifit CSA series/Chemifit CS series
Chemifit CP series

Bamboo-shoot fitting series

Barb type

Control Switch and Detachable Products **P.142**

Handling instructions INDEX

Compact speed controller/Chemifit C1 speed controller/Speed controller
Ball valve/Throttle valve/Miniature valve
Valve built-in connector/Q.D.C 101 series/Q.D.C 103 series

Jigs, Tools and Accessories **P.166**

INDEX

Tube cutter/FW tube outer cover peeling cutter/FWU tube outer cover peeling cutter
Spatter cap/Off tool/ Tube reel
Air balancer/Tool balancer

Technical Information **P.170**

INDEX

Speed controller flow characteristics/Effective cross-sectional area/Negative-pressure performance list/Instruction manual

Reference **P.198**

INDEX

Applied standard list/Screw standard list/UL-94 standard flame test/Table of full scale tube and screw/Unit conversion table/
Chemical resistance specification table/

Index of Product Number **P.214**

Tube

Clean tube

Processed tube

PushOne fitting

QuickSeal fitting

Clean fitting/Chemifit

Bamboo-shoot fitting

Control switch/Detachable series

Jig/Tool/Accessory

Technical information

Reference

INDEX

Tube

Polyurethane tube

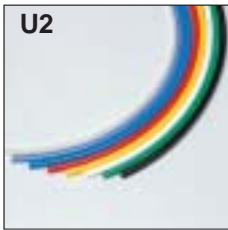

U2

For general air pressure

- Well balanced between flexibility and pressure-resistance performance

P.12

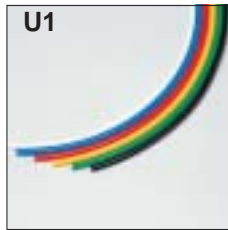

U1

For general air pressure

- Usable in higher air-pressure range than U2

P.13

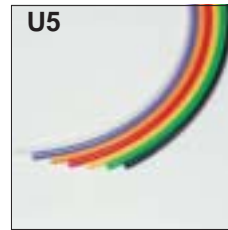

U5

For general air pressure (Ultra flexible)

- High workability with small bending stress

P.14

Nylon tube

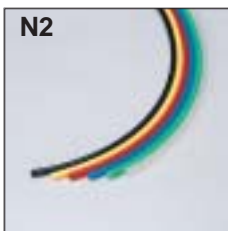

N2

For multi purpose piping

- High oil resistance and chemical resistance

P.15

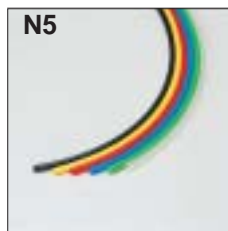

N5

Soft nylon

- High workability with small bending stress

P.16

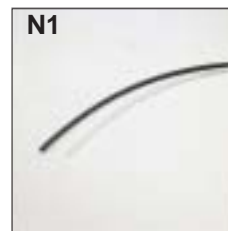

N1

Hard (unplasticized) nylon

- Unplasticized nylon

P.17

Flexible fluorocarbon resin bilayer tube



TES

For coating (flexible)

- Bilayer structure of inner (special fluorocarbon resin) and outer (special nylon resin) layers
- High flexibility

P.18

Flame-resistant tube



FS

For spot welding piping

- High flame resistance (Compliant V-0 of UL94 standard)
- High flexibility

P.20



FW

For spot welding piping (bilayer)

- High flame resistance (Compliant V-0 of UL94 standard)
- Bilayer structure with flame-resistant resin inner and outer layers

P.21

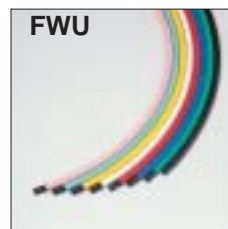

FWU

For spot welding piping (flexible)

- High flame resistance (Compliant V-0 of UL94 standard)
- Bilayer structure with polyurethane tube inner layer, high flexibility

P.22

Antistatic tube



UE

For general air pressure (electrically conductive)

- Conductive polyurethane elastomer for spark prevention

P.23

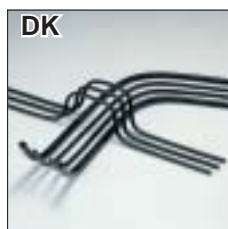

DK

Shape keeping

- Piping shape is kept.
- Easy construction compared to copper

P.24

Polybutene tube

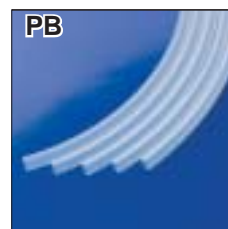

PB

For food processing machines

- Suitable for high temperature antimicrobial cleaning of food processing machines
- Compliant with the 20th notification of Ministry of Health and Welfare, Japan (1982).

P.25

Tube

Clean tube

Processed tube

PushOne fitting

QuickSeal fitting

Clean fitting/Chemifit

Bamboo-shoot fitting

Control switch/Detachable series

Jig/Tool/Accessory

Technical information

Reference

INDEX

Clean Tube

Polyolefin resin tube

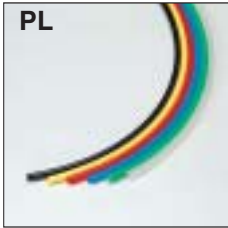

PL

For clean piping

- Suitable for fluids such as clean air, N₂ gas, pure water and various chemical liquids
- Environment-friendly eco tube
- Produced, end-sealed, heat-sealed for shipping in a cleanroom

P.26

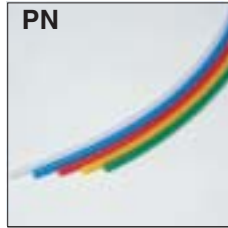

PN

For clean piping (flexible)

- Suitable for fluids such as clean air, N₂ gas, pure water and various chemical liquids
- Environment-friendly eco tube
- Produced, end-sealed, heat-sealed for shipping in a cleanroom
- High workability with small bending stress

P.27

Fluorocarbon resin tube



TA

For clean, heat-resistant, cold-resistant, chemical-resistant use

- PFA resin tube with high chemical resistance
- Produced, end-sealed, heat-sealed for shipping in a cleanroom

P.28



TP

For clean, heat-resistant, cold-resistant, chemical-resistant use

- FEP resin tube with high chemical resistance
- Produced, end-sealed, heat-sealed for shipping in a cleanroom

P.29

Processed Tube

Polyurethane coil tube



UC
USC
UMC

Polyurethane coil

- Coil tube for general air pressure

P.30

Multi-line tube

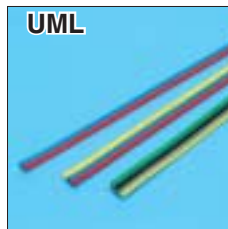

UML

Polyurethane multi-line

- Multi-core welding tube for general air pressure

P.31

Nylon coil tube



S

Nylon coil

- Single core nylon coil tube with strong restoring force

P.32

Multi-pack tube



1213

Bundled tube

- Processed tube for multi piping (Made to order)

P.33

Tube

Clean tube

Processed tube

PushOne fitting

QuickSeal fitting

Clean fitting/Chemifit

Bamboo-shoot fitting

Control switch/Detachable series

Jig/Tool/Accessory

Technical information

Reference

INDEX

PushOne® series

PushOne® A series



For general air pressure

- PushOne® connection
- High flame resistance (Compliant V-0 of UL94 standard)
- Electroless nickel plated

P.36

PushOne® E series



For general air pressure

- PushOne® connection
- High flame resistance (Compliant V-0 of UL94 standard)
- Electroless nickel plated

P.50

PushOne® E series

Mini type



For general air pressure

- PushOne® connection
- Compact
- Electroless nickel plated

P.66

Brass body type



For general air pressure

- PushOne® connection
- Electrically conductive if combined with UE tube
- High flame resistance (Compliant V-0 of UL94 standard)

P.72

QuickSeal series

QuickSeal series

Insertion type (brass)



For multi-purpose piping

- Screw-in type
- High sealing performance
- Only connector is sealed.

P.76

Insertion type (stainless)



For multi-purpose piping

- Screw-in type
- High sealing performance
- Made of SUS304

P.88

Insertless type



For general air pressure

- Screw-in type
- For large flow volume

P.94

QuickSeal series

DK tube dedicated type



For general air pressure

- Screw-in type

P.98

Nylon coil tube dedicated type



For general air pressure

- Screw-in type

P.102

Tube

Clean tube

Processed tube

PushOne fitting

QuickSeal fitting

Clean fitting/
Chemifit

Bamboo-shoot fitting

Control switch/
Detachable series

Jig/Tool/
Accessory

Technical information

Reference

INDEX

Chemifit® series

Chemifit® C1 series



For clean air, pure water, chemical liquid piping

- No-oil processed
- PushOne® connection
- Nonmetal liquid-contact surface
- High dust-free, uncontaminated performance
- Double clean package

P.104

Chemifit® C1S series



For clean air, pure water, chemical liquid piping

- No-oil processed
- PushOne® connection
- SUS304 screw
- Double clean package
- High dust-free, uncontaminated performance

P.112

Chemifit® CSA series



For clean air, pure water, chemical liquid piping

- Screw-in type fitting made of SUS316
- High workability of tube with assembly nut
- Uniform workability for connecting tube
- No rotation of tube when tightening nut
- No-oil processed
- High sealing performance
- No need for additional tightening of assembly nut

P.118

Chemifit® CS series



For clean air, pure water, chemical liquid piping

- Screw-in type fitting made of SUS316
- Uniform workability for connecting tube
- No rotation of tube when the tube is attached
- No-oil processed
- High sealing performance
- No need for additional tightening of assembly nut

P.126

Chemifit® CP series



For clean air, pure water, chemical liquid piping

- Screw-in type fitting made of polypropylene resin
- No-oil processed
- Highly smooth inner surface
- High dust-free, uncontaminated performance

P.134

No-oil processing, clean wrapping and clean package

- Ultrasonic cleaning with no oil and fat used for assembling in a cleanroom

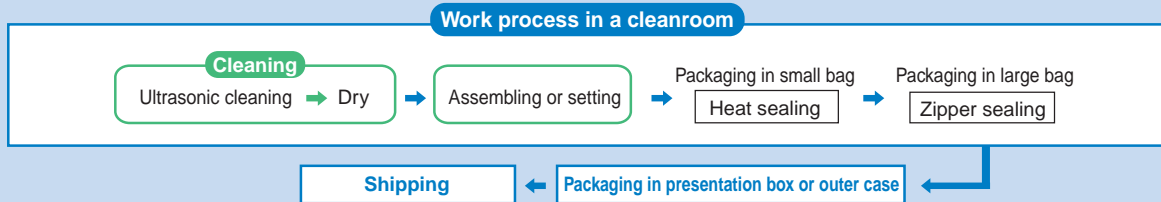

Bamboo-shoot fitting series

Bamboo-shoot fitting series



Barb type

Bamboo-shoot fitting

- Bamboo-shoot type
- Sealing-processed R thread
- Various shape combinations available

P.140

Tube

Clean tube

Processed tube

PushOne fitting

QuickSeal fitting

Clean fitting/Chemifit

Bamboo-shoot fitting

Control switch/Detachable series

Jig/Tool/Accessory

Technical information

Reference

INDEX

Control Switch and Detachable Series

Control series

Compact speed controller



- Smaller than the conventional model
- PushOne® connection
- Electroless nickel plated
- Sealing-processed R thread

P.144

Control series

Chemifit® C1 speed controller



- Suitable for environment (atmosphere) that requires chemical-resistance
- PushOne® connection
- Inline type (ESU) allows central control on piping line.

P.146

Control series

Speed controller



- PushOne® connection
- Universal type (ESD) can be connected in any direction.
- Inline type (ESU) allows central control on piping line.
- Electroless nickel plated
- Sealing-processed R thread

P.148

Switch series

Ball valve



- Realizing compact piping
- PushOne® connection
- Position of handle can be changed.
- Nickel plated

P.151

Control series

Throttle valve



- Fine control of flow rate
- Inline type (ESU) allows central control on piping line.
- PushOne® connection
- Electroless nickel plated

P.154

Miniature valve



- Easy flow rate control
- PushOne® connection for millimeter size type (quick seal type for inch size type)

P.156

Detachable series

Valve built-in connector



- Opening/Closing valve inside fitting by detaching tube
- PushOne® connection
- Electroless nickel plated

P.159

Detachable series

Q.D.C 101



Compact coupler for air pressure

- Push-To-Connect type
- Automatic opening/closing valve inside the coupler
- PushOne® fitting integrated types available

P.160

Q.D.C 103



Micro coupler for air and oil pressure

- Push-To-Connect type
- Automatic opening/closing valve inside the coupler
- Smaller than 101 series
- Electroless nickel plated

P.163

Tube

Clean tube

Processed tube

PushOne fitting

QuickSeal fitting

Clean fitting/Chemifit

Bamboo-shoot fitting

Control switch/Detachable series

Jig/Tool/Accessory

Technical information

Reference

INDEX

Jigs, Tools and Accessories

Tube cutter

TC04



- Compact, handy-carrying, light weight tube cutter
- The blade is replaceable. It comes with three spare blades.
- Can cut tubes of up to 13mm diameter.

P.167

TC01



- Highly durable nipper-type tube cutter
- Can cut tubes of up to 13mm diameter.

P.167

Hose cutter

HC03



- Highly durable nipper-type tube cutter
- Can cut tubes of up to 20mm diameter.

P.167

FW/FWU tube outer cover peeling cutter

**TC02
TC03**



- Easy peeling of FW tube outer cover

P.168

**TC02U
TC03U**



- Easy peeling of FWU tube outer cover

P.168

Spatter cap

CP·CPF·CPP



- Protecting PushOne connecting part from spatter (hot wasted metal), etc
- CCP can be attached after connecting tube.

P.169

Off tool

EOT



- Easy removal of PushOne fitting from tube

P.169

Tube reel

PTR



- Easy handling
- Recycled polypropylene resin used

P.169

Tube

Clean tube

Processed tube

PushOne fitting

QuickSeal fitting

Clean fitting/
Chemfit

Bamboo-shoot fitting

Control switch/
Detachable series



Jig/Tool/
Accessory

Technical information

Reference

Combination List of Tube and Fitting (Working temperature range)

- See “Chemical resistance specification table” at the end of this catalog if a chemical is contained in fluid or atmosphere. Propriety of usage should be judged based on your use condition data.
- Before using the tube and fitting in combination, read the handling instructions of each product carefully.

Fitting type Tube type		Series	PushOne series				QuickSeal series					Bamboo-shoot series		
			Product	A series	E series	E series		Insertion type (brass)		Insertion type (SUS304)	Insertless type	DK tube fitting	Nylon coil tube fitting	Barb type
		Fluid				mini type	Brass body type							
Tube	Polyurethane tube	U2	Air	-20→+80	-20→+80	-20→+80	-20→+80	-40→+80		-40→+80				
			Water	0→+40	0→+40			0→+50		0→+50				
		U1	Air	-20→+80	-20→+80	-20→+80	-20→+80	-40→+80		-40→+80				
	Water		0→+40	0→+40			0→+50		0→+50					
	Nylon tube	N5	Air	-20→+80	-20→+80	-20→+80	-20→+80	-40→+80	-40→+100	-40→+80	-40→+100			
			Water	0→+40	0→+40			0→+50		0→+50				
			General operating oil					-40→+80	-40→+100	-40→+80				
		N2	Air	-20→+80	-20→+80	-20→+80	-20→+80	-40→+80	-40→+100	-40→+80	-40→+100			
			Water	0→+40	0→+40			0→+70		0→+70				
			General operating oil					-40→+80	-40→+100	-40→+80				
		N1	Air	-20→+80	-20→+80	-20→+80	-20→+80	-40→+80	-40→+100	-40→+80	-40→+100			
			Water	0→+40	0→+40			0→+70		0→+70				
			General operating oil					-40→+80	-40→+100	-40→+80				
	Flexible fluorocarbon resin tube	TES	Air					-40→+80	-40→+80					
			Water					0→+70		0→+70				
Water-based paint (-4)							0→+40		0→+40					
Shape-keeping tube	DK	Air								-40→+60				
Polybutene tube	PB	Air					-10→+80	-10→+90	-10→+80					
		Water					0→+70		0→+70					
Flame-resistant tube	FS	Air	-20→+80	-20→+80		-20→+80		-40→+100(*1)	-40→+80					
		Water	0→+40	0→+40			0→+70(*1)		0→+70					
	FW	Air	-20→+80	-20→+80		-20→+80		-40→+80(*1)	-40→+80					
		Water	0→+40	0→+40			-0→+70(*1)		0→+70					
	FWU	Air	-20→+80	-20→+80		-20→+80		-40→+80(*1)	-40→+80					
		Water	0→+40	0→+40			-0→+50(*1)		0→+50					
Antistatic tube	UE	Air	-20→+80(*3)	-20→+80(*3)	-20→+80(*3)	-20→+80(*3)	-40→+80		-40→+80					
Clean tube	Polyolefin resin tube	PL	Air (Clean air)	-20→+80(*2)	-20→+80(*2)	-20→+80(*2)	-20→+80(*2)	-40→+80(*2)		-40→+80(*2)				
			Water (pure water)	0→+40(*2)	0→+40(*2)			0→+70(*2)		0→+70(*2)				
	PN	Air (Clean air)	-20→+80(*2)	-20→+80(*2)	-20→+80(*2)	-20→+80(*2)	-40→+80(*2)		-40→+80(*2)					
		Water (pure water)	0→+40(*2)	0→+40(*2)			0→+70(*2)	0→+80(*2)	0→+70(*2)					
Fluorocarbon resin tube	TA	Air (Clean air)	-20→+80(*2)	-20→+80(*2)	-20→+80(*2)	-20→+80(*2)	-40→+80(*2)	-40→+100(*2)	-40→+80(*2)					
		Water (pure water)	0→+40(*2)	0→+40(*2)			0→+70(*2)	0→+100(*2)	0→+70(*2)					
	TP	Air (Clean air)	-20→+80(*2)	-20→+80(*2)	-20→+80(*2)	-20→+80(*2)	-40→+80(*2)		-40→+80(*2)					
		Water (pure water)	0→+40(*2)	0→+40(*2)			0→+70(*2)		0→+70(*2)					
Processed tube	Polyurethane processed tube	UC	Air					-40→+80	-40→+80					
		USC	Air					-40→+80	-40→+80					
		UMC	Air					-40→+80	-40→+80					
		UML	Air					-40→+80	-40→+80					
Nylon coil tube	S	Air								-40→+100				

*1 If spatter (hot wasted metal) is likely to cling to the connection part of tube, use a brass tube instead of a nylon one.

*2 This is a combination of the clean type and the general type.

When using them in a clean environment, pay attention to the clean level that could be lowered.

*3 Use a brass body type of connector and internal connector to keep fittings and the tube electrically conductive.

*4 Use water-based paint, or aliphatic or aromatic carbon hydride solvent. Contact us for other types of fluid.

Tube

Clean tube

Processed tube

PushOne fitting

QuickSeal fitting

Clean fitting/ Chemifit













Bamboo-shoot fitting

Control switch/ Detachable series

Jig/Tool/ Accessory

Technical information

Reference

	Clean fitting, Chemifit series					Control switch, detachable series							Series	Fitting type	
	C1 series 	C1S series 	CSA series 	CS series 	CP series 	Compact speed controller 	Chemifit C1 speed controller 	Speed controller 	Ball valve 	Throttle valve 	Miniature valve				Product
											PushOne type 	QuickSeal type 			
	-20→+80(*2)	-20→+80(*2)	-40→+80(*2)	-40→+80(*2)		+5→+60	+5→+60	+5→+60	-20→+80	-20→+80	-20→+80	-20→+80	Air	U2	
	0→+50(*2)	0→+50(*2)	0→+50(*2)	0→+50(*2)					0→+40	0→+40	0→+40	0→+40	Water		
	-20→+80(*2)	-20→+80(*2)	-40→+80(*2)	-40→+80(*2)		+5→+60	+5→+60	+5→+60	-20→+80	-20→+80	-20→+80		Air	U1	
	0→+50(*2)	0→+50(*2)	0→+50(*2)	0→+50(*2)					0→+40	0→+40	0→+40		Water		
			-40→+60(*2)	-40→+60(*2)				+5→+60	-20→+80	-20→+80	-20→+80		Air	U5	
						+5→+60		+5→+60	-20→+80	-20→+80	-20→+80	-20→+80	Air	N5	
									0→+40	0→+40	0→+40	0→+40	Water		
													General operating oil		
						+5→+60		+5→+60	-20→+80	-20→+80	-20→+80	-20→+80	Air	N2	
									0→+40	0→+40	0→+40	0→+40	Water		
													General operating oil		
						+5→+60		+5→+60	-20→+80	-20→+80	-20→+80	-20→+80	Air	N1	
									0→+40	0→+40	0→+40	0→+40	Water		
													General operating oil		
			-40→+100(*2)	-40→+100(*2)									Air	TES	
			0→+70(*2)	0→+70(*2)									Water		
			0→+40(*2)	0→+40(*2)									Water-based paint (*4)		
													Air	DK	
			-10→+90(*2)	-10→+90(*2)								-10→+80	Air	PB	
			0→+90(*2)	0→+90(*2)								0→+40	Water		
						+5→+60		+5→+60	-20→+80	-20→+80	-20→+80		Air	FS	
									0→+40	0→+40	0→+40		Water		
						+5→+60		+5→+60	-20→+80	-20→+80	-20→+80		Air	FW	
									0→+40	0→+40	0→+40		Water		
						+5→+60		+5→+60	-20→+80	-20→+80	-20→+80		Air	FWU	
									0→+40	0→+40	0→+40		Water		
			-40→+60(*2)	-40→+60(*2)									Air	UE	
	-20→+80	-20→+80	-60→+80	-60→+80	-20→+80	+5→+60(*2)	+5→+60	+5→+60(*2)	-20→+80(*2)	-20→+80(*2)	-20→+80(*2)	-20→+80(*2)	Air (Clean air)	PL	
	0→+80	0→+80	0→+80	0→+80	0→+80				-0→+40(*2)	-0→+40(*2)	-0→+40(*2)	-0→+40(*2)	Water (pure water)		
	-20→+80	-20→+80	-60→+80	-60→+80		+5→+60(*2)	+5→+60	+5→+60(*2)	-20→+80(*2)	-20→+80(*2)	-20→+80(*2)		Air (Clean air)	PN	
	0→+80	0→+80	0→+80	0→+80					-0→+40(*2)	-0→+40(*2)	-0→+40(*2)		Water (pure water)		
	-20→+80	-20→+80	-65→+260	-65→+260	-20→+80		+5→+60	+5→+60(*2)	-20→+80(*2)	-20→+80(*2)	-20→+80(*2)	-20→+80(*2)	Air (Clean air)	TA	
	0→+80	0→+80	0→+100	0→+100					-0→+40(*2)	-0→+40(*2)	-0→+40(*2)	-0→+40(*2)	Water (pure water)		
	-20→+80	-20→+80			-20→+80		+5→+60	+5→+60(*2)	-20→+80(*2)	-20→+80(*2)	-20→+80(*2)	-20→+80(*2)	Air (Clean air)	TP	
	0→+80	0→+80			0→+80				-0→+40(*2)	-0→+40(*2)	-0→+40(*2)	-0→+40(*2)	Water (pure water)		
			-40→+80(*2)	-40→+80(*2)									Air	UC	
			-40→+80(*2)	-40→+80(*2)									Air	USC	
			-40→+80(*2)	-40→+80(*2)									Air	UMC	
			-40→+80(*2)	-40→+80(*2)									Air	UML	
													Air	S	

Tube

Clean tube

Processed tube

PushOne fitting

QuickSeal fitting

Clean fitting/ Chemifit

Bamboo-shoot fitting

Control switch/ Detachable series

Jig/Tool/ Accessory

Technical information

Reference

TUBE

Tube

Handling instructions for tube products

⚠ Safety Note

This Safety Note provides indications on the correct use of the product in order to prevent harm to people and property. The indications are classified into three categories, "danger", "warning", and "caution", depending on the level of potential harm due to improper use. Each category contains important instructions on safety that should be followed in addition to the latest ISO 4414(*1), JIS B 8370(*2), ISO4413 (*3), and JIS B 8361 (*4).

*1 ISO4414 Pneumatic fluid power...Recommendations for the application of equipment to transmission and control systems.

*2 JIS B 8370 Pneumatic System General Rules

*3 ISO4413 Hydraulic fluid power...General rules for the application of equipment to transmission and control systems.

*4 JIS B 8361 Hydraulic System General Rules

⚠ DANGER

Where inappropriate use of this equipment may cause death or severe injury and where immediate warning of a dangerous situation is highly required.

⚠ WARNING

Where inappropriate use of this equipment may cause death or severe injury.

⚠ CAUTION

Where inappropriate use of this equipment may cause minor injury.

⚠ Before Selection

⚠ DANGER

•Cannot use for machines or equipment for life support.

•To use for machines or equipment that require extremely high safety, measures have to be taken to prevent danger in case of pulling out, burst and leakage.

⚠ WARNING

•Please contact us before using our products under conditions other than those specified in the catalog.

•Please contact us before using our products for equipment, machines, various types of vehicles, and passenger aircraft, for leisure equipment passenger transport, for medical equipment that would cause human harm in case the specifications are inappropriately followed, and for machines in contact with food or drinking water.

⚠ Selection

⚠ WARNING

•Please check that our products are used under the "use conditions" specified in the catalog.

•Do not use our products when a caustic or flammable gas is used as the fluid or is in the environment.

⚠ CAUTION

•Do not use our products in places where excessive vibration or impact may occur.

•If use conditions differ between the tube and the fitting, use them under the lower specified conditions.

•For Nitta's tube products, use fitting products that Nitta specifies or JIS B 8381-1995 on-spec products.

•When water is used as the operating fluid, the tube material might degrade depending on the additive. Contact us for details.

•The ultraviolet rays in direct sunlight and fluorescent light could enhance degradation and shorten the life of the tube.

•When a chemical is used in fluid or the environment, see "Chemical resistance specification table".

•When spatter (hot wasted metal) is likely to stick to the tube, use flame-resistant products only. Otherwise the spatter may cause a fire.

•The maximum working pressure of a tube varies with working temperature. See "Relation between the working temperature and the maximum working pressure."

⚠ Installation

⚠ WARNING

•Fix tubes when installing them in a place where unexpected disconnection of the tube and connector could cause harm to people or property.

⚠ CAUTION

•Instructions for connecting tubes are given in a separated document. Please read it and follow the installation instructions.

•Nitta only guarantees products fabricated by designated companies.

•Prevent damage to tubes, e.g. entanglement or abrasion. It could cause flattening, destruction, and disconnection.

•Install tubes so as to prevent loads such as tension, torsion, rotation, and bending with a radius smaller than the minimum bending radius.

•Do not bend a tube, which might cause "fatigue destruction" at the break point even under the maximum working pressure.

•When the connection part of a tube is dirty, clean the surface.

•Do not use tubes if they are dented or damaged.

•Check for any changes in the outer and inner diameters of tubes due to inner pressure or heat before you re-connect it to a fitting. Replace any tubes that are affected.

⚠ Usage

⚠ WARNING

•Nitta's products should be handled only by designers who have sufficient knowledge of equipment, instruments and systems in which our products are to be installed, or by persons responsible for determining specifications. Test and analysis should be conducted if necessary. The designers or the responsible persons are liable for the performance and the safety of the equipment, instruments and systems.

⚠ CAUTION

•When water is used as fluid, do not allow it to freeze.

•Do not touch a tube at pressurization. Improperly treating or touching a tube at pressurization may lead to danger from unexpected breakage or leakage of fluid.

•Do not touch a tube when the operating fluid is hot. Doing so may cause burns.

⚠ Storage

⚠ CAUTION

•When storing unused products, make sure to keep them in a clean place to prevent dust. When fine particles such as dust enter the inside of tube products or the connected equipment, they may cause problems.

•Keep products in a dry place below 40°C avoiding direct sunlight. In particular, if nylon tubes and flame-resistant tubes are stored for a long period in a high-temperature high-humidity environment, white powder extract sometimes appears through the plasticizer on their surface, although it does not affect tube performance.

•Do not use tube products that have been stored for more than one year after production.

•The packaging of clean tubes should be opened just before use. Store the tubes in a box in a clean place in a dust-free environment.

⚠ Maintenance and Inspection

⚠ CAUTION

•Before handling or removing Nitta's products, be sure to check the safety by shutting off the power supply, stopping the pressure supply, evacuating pressurized air in the pipe, and terminating the operation of equipment, instruments, and systems.

•Please be sure to make periodic inspection. Confirm that there is no degradation such as outer damage, corrosion, and abrasion and replace any damaged piping.

⚠ Disposal

⚠ CAUTION

•Dispose of unnecessary products as industrial waste or have them disposed of by a waste disposal firm. In particular, incineration of products containing fluorocarbon may generate a toxic pyrolysis gas.

TUBE INDEX

Polyurethane tube

For general air pressure



For general air pressure (high pressure type)



For general air pressure (ultra flexible)

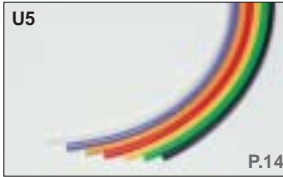

Nylon tube

For multi purpose piping



Soft nylon



Hard (unplasticized) nylon



Flexible fluorocarbon resin bilayer tube

For coating (flexible and abrasion resistant)



Flame-resistant tube

For spot welding piping



For spot welding piping (bilayer)



For spot welding piping (flexible)



Antistatic tube

For general air pressure (electrically conductive)



Shape-keeping tube

Shape keeping



Polybutene tube

For food processing machines



Polyolefin resin tube

For clean piping (flexible)



For clean piping (flexible)



Fluorocarbon resin tube

For clean, heat-resistant, cold-resistant, chemical-resistant use



For clean, heat-resistant, cold-resistant, chemical-resistant use



Polyurethane coil tube

Polyurethane coil



Multi-line tube

Polyurethane multi-line tube



Nylon coil tube

Nylon coil



Multi-pack tube

Bundled



Tube

Clean tube

Processed tube

PushOne fitting

QuickSeal fitting

Clean fitting/ Chemifit

Bamboo-shoot fitting

Control switch/ Detachable series

Jig/Tool/ Accessory

Technical information

Reference

Polyurethane Tube

U2

For general air pressure

Features

- Well balanced between flexibility and pressure-resistant performance, and high workability. Most suitable for general air pressure piping usage.
- Ether polyurethane resin is used to prevent degradation by water or mold under high temperature and high humidity.
- Coil processing and welding can be performed on request.



Product number table

● Millimeter size type (Group 4)

Type	Outer diameter × Inner diameter (mm)	Max. working pressure (MPa at 20°C)	Min. bending radius (mm)	Weight (g/m)	Standard color (color symbol)								
					Black	White	Yellow	Blue	Green	Red	Clear	Clear blue	
					BK	WH	YL	BU	GN	RE	CL	CBU	
U2-4-3×2	3×2	(Air) 0.8	10	5	●	—	—	—	—	—	—	—	—
U2-4-4×2.5	4×2.5		10	9	●	○	●	●	●	●	○	○	
U2-4-6×4	6×4		15	19	●	○	●	●	●	●	○	○	
U2-4-8×5	8×5	(Water) 0.6	23	35	●	○	●	●	●	●	○	○	
U2-4-10×6.5	10×6.5		30	52	●	○	●	●	●	●	○	○	
U2-4-12×8	12×8		35	72	●	○	●	●	●	●	○	○	
U2-4-16×12	16×12		50	103	●	—	—	—	—	—	—	—	

● Inch size type (Group 1)

Type	Outer diameter × Inner diameter (mm)	Max. working pressure (MPa at 20°C)	Min. bending radius (mm)	Weight (g/m)	Standard color (color symbol)					
					Black	Yellow	Blue	Green	Red	Clear
					BK	YL	BU	GN	RE	CL
U2-1-3/16	4.76×3.48	(Air) 0.6	13	10	●	●	●	●	●	○
U2-1-1/4	6.35×4.57		20	18	●	●	●	●	●	○
U2-1-5/16	7.94×5.90		27	26	●	●	●	●	●	○
U2-1-3/8	9.53×6.99	(Water) 0.4	28	39	●	●	●	●	●	○
U2-1-1/2	12.70×9.56		35	65	●	●	●	●	●	○

Standard length

20M, 100M ☞ U2-4-16×12: 50M only

Product number example

U2 - 4 - 6×4 - BK - 100M

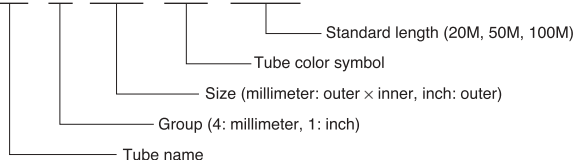

Operating fluid, working temperature range

Operating fluid	Working temperature range
Air	-40°C~+80°C
Water	0°C~+50°C

Negative pressure performance

-101.294kPa

Relation between the working temperature and the maximum working pressure

The maximum working pressure varies with the working temperature (environmental temperature). For use at an abnormal temperature, always check the maximum working pressure change in the graph below and keep the pressure within the indicated range.

⚠ Caution Using tubes at a pressure outside the range may cause accidents or damage, for which Nitta is not liable.

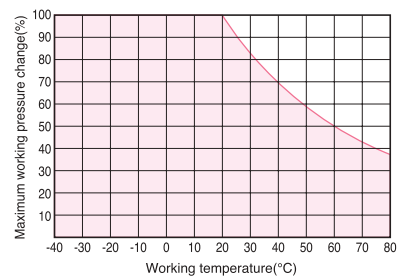

Handling instructions

⚠ Caution When water is used as the operating fluid, the tube material might degrade depending on the additive. Contact us for details.

⚠ Caution When water is used as the operating fluid, keep the surge pressure under the maximum working pressure. Also, do not allow the water to freeze.

☞ See page 10 for common instructions for tube products.

Applicable fittings

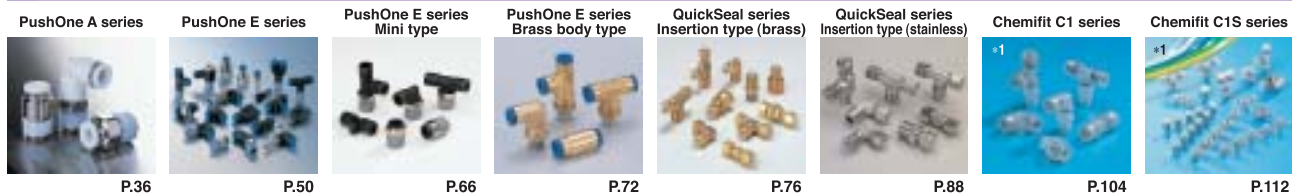

Applicable fittings

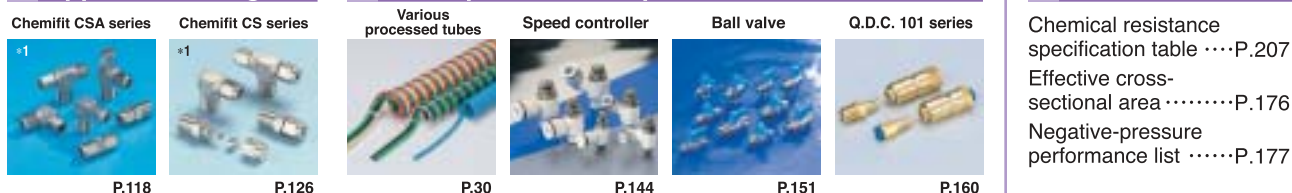

Reference

Chemical resistance specification tableP.207
Effective cross-sectional areaP.176
Negative-pressure performance listP.177

(*1) Combinatory use of U2 tube and Chemifit series mixes general and clean type performances. When using them in a clean environment, pay attention to the clean level that could be lowered.

Polyurethane Tube

U1

For general air pressure (high pressure type)

Features

- Usable in higher air-pressure range than U2 tube
- Ether polyurethane resin is used to prevent degradation by water or mold under high temperature and high humidity.
- Coil processing and welding can be performed on request.



Product number table

● Millimeter size type (Group 4)

Type	Outer diameter × Inner diameter (mm)	Max. working pressure (MPa at 20°C)	Min. bending radius (mm)	Weight (g/m)	Standard color (color symbol)					
					Black	White	Yellow	Blue	Green	Red
					BK	WH	YL	BU	GN	RE
U1-4-4×2.5	4×2.5	(Air) 1.2	10	9	●	○	●	●	●	●
U1-4-6×4	6×4		15	19	●	○	●	●	●	●
U1-4-8×5	8×5		23	36	●	○	●	●	●	●
U1-4-10×6.5	10×6.5	(Water) 0.9	30	53	●	—	—	—	—	—
U1-4-12×8	12×8		35	73	●	—	—	—	—	—

Standard length

20M, 100M

Product number example

U1 - 4 - 6×4 - BK - 100M

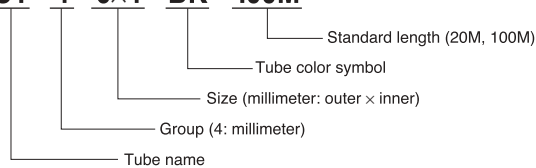

Operating fluid, working temperature range

Operating fluid	Working temperature range
Air	-40°C~+80°C
Water	0°C~+50°C

Negative pressure performance

-101.294kPa

Relation between the working temperature and the maximum working pressure

The maximum working pressure varies with the working temperature (environmental temperature). For use at an abnormal temperature, always check the maximum working pressure change in the graph below and keep the pressure within the indicated range.

⚠ Caution Using tubes at a pressure outside the range may cause accidents or damage, for which Nitta is not liable.

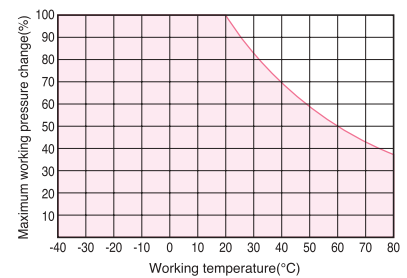

Handling instructions

⚠ Caution When water is used as the operating fluid, the tube material might degrade depending on the additive. Contact us for details.





⚠ Caution When water is used as the operating fluid, keep the surge pressure below the maximum working pressure. Also, do not allow the water to freeze.

📖 See page 10 for common instructions for tube products.

Applicable fittings

PushOne A series  P.36	PushOne E series  P.50	PushOne E series Mini type  P.66	PushOne E series Brass body type  P.72	QuickSeal series Insertion type (brass)  P.76	QuickSeal series Insertion type (stainless)  P.88	Chemifit C1 series  P.104	Chemifit C1S series  P.112
--	--	--	--	---	--	---	--

Applicable fittings

Chemifit CSA series  P.118	Chemifit CS series  P.126	Speed controller  P.144	Ball valve  P.151	Q.D.C. 101 series  P.160
--	---	---	---	--

Allied products and product introduction

Reference

Chemical resistance specification tableP.207
Effective cross-sectional areaP.176
Negative-pressure performance listP.177

(*1) Combinatory use of U1 tube and Chemifit series mixes general and clean type performances. When using them in a clean environment, pay attention to the clean level that could be lowered.

Polyurethane Tube

U5

For general air pressure (ultra flexible)

Features

- The smallest bending stress among polyurethane tubes ensures high workability.
- Ether polyurethane resin is used to prevent degradation by water or mold under high temperature and high humidity.
- Usable for barb fittings (bamboo-shoot fittings).



Product number table

● Millimeter size type (Group 4)

Type	Outer diameter × Inner diameter (mm)	Max. working pressure (MPa at 20°C)	Min. bending radius (mm)	Weight (g/m)	Standard color (color symbol)							
					Black	Yellow brown	Clear	Clear blue	Clear green	Clear red	Clear yellow	
					BK	BYL	CL	CBU	CGN	CRE	CYL	
U5-4-3.5×2	3.5×2	0.4	7	8	●	●	○	○	○	○	○	
U5-4-4×2.5	4×2.5		10	9	●	●	○	○	○	○	○	
U5-4-6×4	6×4		15	19	●	●	○	○	○	○	○	

Standard length

20M, 100M

Product number example

U5 - 4 - 6×4 - BK - 100M

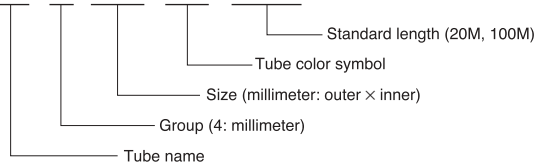

Operating fluid, working temperature range

Operating fluid	Working temperature range
Air	-40°C~+80°C

Negative pressure performance

-101.294kPa

Relation between the working temperature and the maximum working pressure

The maximum working pressure varies with the working temperature (environmental temperature). For use at an abnormal temperature, always check the maximum working pressure change in the graph below and keep the pressure within the indicated range.

⚠ Caution Using tubes at a pressure outside the range may cause accidents or damage, for which Nitta is not liable.

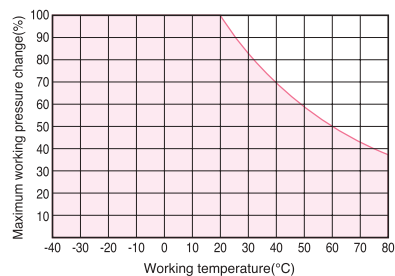

Handling instructions

⚠ Caution Water should not be used for operating fluid because of possible hydrolysis.

📖 See page 10 for common instructions for tube products.

Applicable fittings



(*1) Combinatory use of U5 tube and Chemifit series mixes general and clean type performances. When using them in a clean environment, pay attention to the clean level that could be lowered.

Allied products and product introduction



Reference

Chemical resistance specification tableP.207
Effective cross-sectional areaP.176
Negative-pressure performance listP.177

Tube

Clean tube

Processed tube

PushOne fitting

QuickSeal fitting

Clean fitting/Chemifit

Bamboo-shoot fitting

Control switch/Detachable series

Jig/Tool/Accessory

Technical information

Reference

Nylon Tube

N2

For multi-purpose piping

Features

- High oil resistance and chemical resistance
- Group 2 type endures up to 4.8MPa (at 20°C).
- High abrasion resistance



Product number table

● Millimeter size type (Group 4)

Type	Outer diameter × Inner diameter (mm)	Max. working pressure (MPa at 20°C)	Min. bending radius (mm)	Weight (g/m)	Standard color (color symbol)					
					Black	Milky white	Yellow	Blue	Green	Red
					BK	MW	YL	BU	GN	RE
N2-4-4×2	4×2	5.0	10	11	●	○	—	—	—	—
N2-4-4×2.5	4×2.5	3.3	15	8	●	○	●	●	●	●
N2-4-4×3	4×3	2.0	20	6	●	○	—	—	—	—
N2-4-6×4	6×4	3.0		17	●	○	●	●	●	●
N2-4-6×4.5	6×4.5	2.0	35	13	●	○	●	●	●	●
N2-4-8×6	8×6			23	●	○	●	●	●	●
N2-4-10×7.5	10×7.5	1.6	45	35	●	○	—	—	—	—
N2-4-10×8	10×8			29	●	○	●	●	●	●
N2-4-12×9	12×9	2.0	100	51	●	○	●	●	●	●
N2-4-16×13	16×13	1.6		70	●	○	—	—	—	—

● Inch size type (Group 1)

Type	Outer diameter × Inner diameter (mm)	Max. working pressure (MPa at 20°C)	Min. bending radius (mm)	Weight (g/m)	Standard color (color symbol)					
					Black	Milky white	Yellow	Blue	Green	Red
					BK	MW	YL	BU	GN	RE
N2-1-1/8	3.18×2.25	2.3	13	4	●	○	—	—	—	—
N2-1-3/16	4.76×3.48		16	9	●	○	●	●	●	●
N2-1-1/4	6.35×4.57		23	16	●	○	●	●	●	●
N2-1-5/16	7.94×5.90		29	23	●	○	●	●	●	●
N2-1-3/8	9.53×6.99		35	35	●	○	●	●	●	●
N2-1-1/2	12.70×9.56		45	58	●	○	●	●	●	●
N2-1-5/8	15.88×11.10	140	107	—	—	—	—	—	—	

● Inch size type (Group 2) –High pressure type–

Type	Outer diameter × Inner diameter (mm)	Max. working pressure (MPa at 20°C)	Min. bending radius (mm)	Weight (g/m)	Standard color (color symbol)	
					Black	Milkywhite
					BK	MW
N2-2-1/8	3.18×1.60	4.8	7	6	●	○
N2-2-3/16	4.76×2.42		12	14	●	○
N2-2-1/4	6.35×3.21		13	25	●	○
N2-2-5/16	7.94×4.02		19	39	●	○
N2-2-3/8	9.53×4.81		26	56	●	○
N2-2-1/2	12.70×6.40		99	99	●	○

☞ Use fittings of insertion type (Group 2) in QuickSeal series.

Standard length

20M, 100M

Product number example

N2 - 4 - 6×4 - BK - 100M

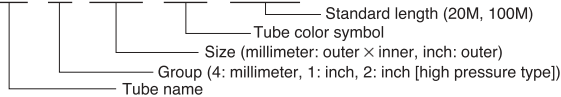

Operating fluid, working temperature range

Operating fluid	Working temperature range
Air	-40°C~+80°C
Water	0°C~+70°C
General operating oil	-40°C~+100°C

☞ Contact us for other operating fluids.

Negative pressure performance

-101.294kPa

Relation between the working temperature and the maximum working pressure

The maximum working pressure varies with the working temperature (environmental temperature). For use at an abnormal temperature, always check the maximum working pressure change in the graph below and keep the pressure within the indicated range.

⚠ Caution Using tubes at a pressure outside the range may cause accidents or damage, for which Nitta is not liable.

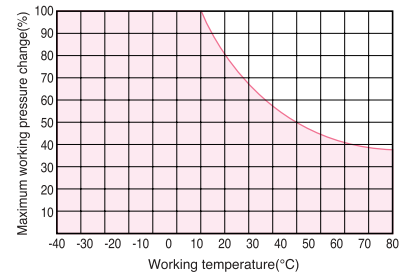

Handling instructions

⚠ Caution When water is used as the operating fluid, the tube material might degrade depending on the additive. Contact us for details.

⚠ Caution When water is used as the operating fluid, keep the surge pressure below the maximum working pressure. Also, do not allow the water to freeze.

☞ See page 10 for common instructions for tube products.

Applicable fittings



Allied products and product introduction

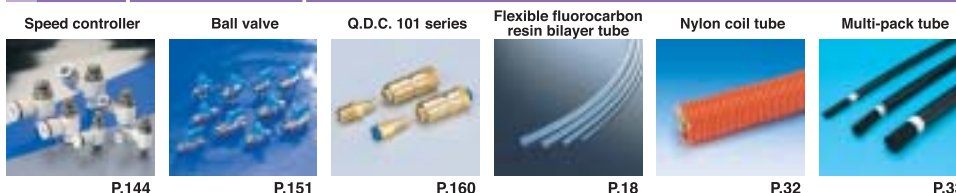

Reference

Chemical resistance specification table ...P.207
Effective cross-sectional area ...P.176
Negative-pressure performance list ...P.177

Nylon Tube

N5

Soft nylon

Features

- Most flexible nylon tube
- High abrasion resistance
- High oil resistance and chemical resistance



Product number table

● Millimeter size type (Group 4)

Type	Outer diameter × Inner diameter (mm)	Max. working pressure (MPa at 20°C)	Min. bending radius (mm)	Weight (g/m)	Standard color (color symbol)					
					Black	Milky white	Yellow	Blue	Green	Red
					BK	MW	YL	BU	GN	RE
N5-4-4×2	4×2	1.8	10	11	●	○	●	●	●	●
N5-4-4×2.5	4×2.5	1.2	15	8	●	○	—	—	—	—
N5-4-4×3	4×3	0.7	20	6	●	○	●	●	●	●
N5-4-6×4	6×4	1.1		17	●	○	●	●	●	●
N5-4-6×4.5	6×4.5	0.7	35	13	●	○	●	●	●	●
N5-4-8×6	8×6			23	●	○	●	●	●	●
N5-4-10×7.5	10×7.5	0.6	45	35	●	○	●	●	●	●
N5-4-10×8	10×8			29	●	○	●	●	●	●
N5-4-12×9	12×9	0.7	100	51	●	○	●	●	●	●
N5-4-16×13	16×13	0.6		70	●	○	—	—	—	—

● Inch size type (Group 1)

Type	Outer diameter × Inner diameter (mm)	Max. working pressure (MPa at 20°C)	Min. bending radius (mm)	Weight (g/m)	Standard color (color symbol)	
					Black	Milky white
					BK	MW
N5-1-3/16	4.76×3.48	0.8	16.0	9.0	●	○
N5-1-1/4	6.35×4.57		23.0	16.0	●	○
N5-1-5/16	7.94×5.90		29.0	23.0	●	○
N5-1-3/8	9.53×6.99		35.0	35.0	●	○
N5-1-1/2	12.70×9.56		45.0	58.0	●	○

Standard length

20M, 100M

Product number example

N5 - 4 - 6×4 - BK - 100M

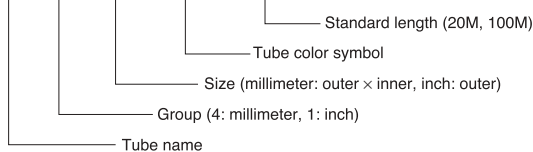

Operating fluid, working temperature range

Operating fluid	Working temperature range
Air	-40°C~+100°C
Water	0°C~+50°C
General operating oil	-40°C~+100°C

☎ Contact us for other operating fluids.

Negative pressure performance

-101.294kPa

Relation between the working temperature and the maximum working pressure

The maximum working pressure varies with the working temperature (environmental temperature). For use at an abnormal temperature, always check the maximum working pressure change in the graph below and keep the pressure within the indicated range.

⚠ Caution Using tubes at a pressure outside the range may cause accidents or damage, for which Nitta is not liable.

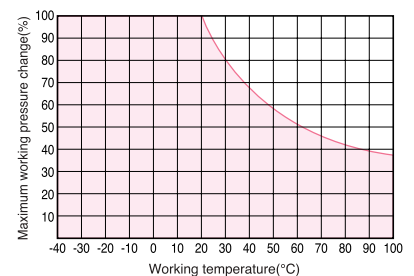

Handling instructions

⚠ Caution When water is used as the operating fluid, the tube material might degrade depending on the additive. Contact us for details.

⚠ Caution When water is used as the operating fluid, keep the surge pressure below the maximum working pressure. Also, do not allow the water to freeze.

☎ See page 10 for common instructions for tube products.

Applicable fittings



Allied products and product introduction



Reference

Chemical resistance specification tableP.207
 Effective cross-sectional areaP.176
 Negative-pressure performance listP.177

Nylon Tube

N1

Hard (unplasticized) nylon

Features

- 100% unplasticized nylon resin tube
- Suitable for high pressure application
- Usable at a high temperature (up to 120°C)



Product number table

● Millimeter size type (Group 4)

Type	Outer diameter × Inner diameter (mm)	Max. working pressure (MPa at 20°C)	Min. bending radius (mm)	Weight (g/m)	Standard color (color symbol)	
					Black	Milky white
					BK	MW
N1-4-6×4	6×4	5.0	20.0	17.0	●	○
N1-4-8×6	8×6	3.3	30.0	23.0	●	○

● Inch size type (Group 1)

Type	Outer diameter × Inner diameter (mm)	Max. working pressure (MPa at 20°C)	Min. bending radius (mm)	Weight (g/m)	Standard color (color symbol)	
					Black	Milky white
					BK	MW
N1-1-1/4	6.35×4.57	4.0	23.0	16.0	●	○

Standard length

20M, 100M

Product number example

N1 - 4 - 6×4 - BK - 100M

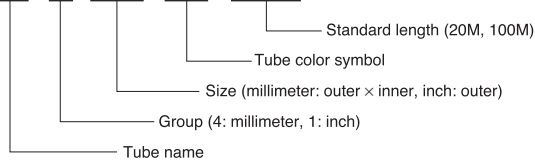

Operating fluid, working temperature range

Operating fluid	Working temperature range
Air	-40°C~+120°C
Water	0°C~+70°C
General operating oil	-40°C~+120°C

☎ Contact us for other operating fluids.

Negative pressure performance

-101.294kPa

Relation between the working temperature and the maximum working pressure

The maximum working pressure varies with the working temperature (environmental temperature). For use at an abnormal temperature, always check the maximum working pressure change in the graph below and keep the pressure within the indicated range.

⚠ Caution Using tubes at a pressure outside the range may cause accidents or damage, for which Nitta is not liable.

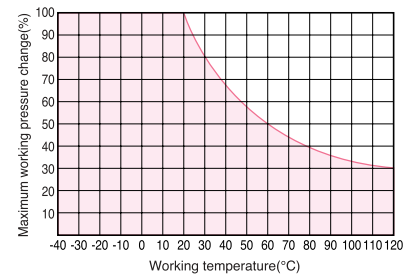

Handling instructions

⚠ Caution When water is used as the operating fluid, the tube material might degrade depending on the additive. Contact us for details.

⚠ Caution When water is used as the operating fluid, keep the surge pressure below the maximum working pressure. Also, do not allow the water to freeze.

☎ See page 10 for common instructions for tube products.

Applicable fittings



Allied products and product introduction

Various bending processing



Contact us for 2- and 3-dimensional bending processing.

Reference

Chemical resistance specification table ...P.207
Effective cross-sectional areaP.176
Negative-pressure performance listP.177

Flexible Fluorocarbon Resin Bilayer Tube

TES

For coating (flexible, abrasion resistant)

Features

- Bilayer structure of inner (special fluorocarbon resin) and outer (special nylon resin) layers
- Super flexible and suitable for movable piping for robots.
- Highly smooth and highly chemical resistant inner surface, and highly abrasion resistant outer surface
- The translucent tube enables the fluid to be seen.

Structure diagram

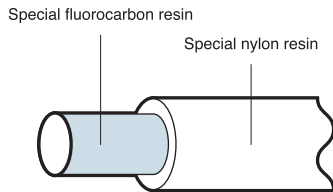

Product number table

● Millimeter size type (Group 4)

Type	Outer diameter × Inner diameter (mm)	Max. working pressure (MPa at 20°C)	Min. bending radius (mm)	Weight (g/m)	Standard color (color symbol)
					Translucent CWH
TES-4-4×2.5	4×2.5	1.8	15	9	○
TES-4-6×4	6×4	1.8	20	18	○
TES-4-8×6	8×6	1.5	35	26	○
TES-4-10×8	10×8	1.1	50	33	○

☞ Inch size type is available on request. Contact us for details.

Standard length

20M, 100M

Product number example

TES - 4 - 6×4 - BK - 100M

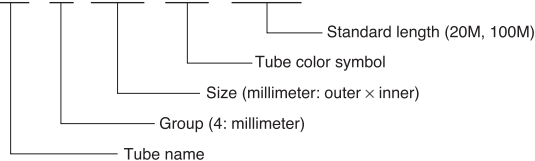

Operating fluid, working temperature range

Operating fluid	Working temperature range
Air	-40°C~+100°C
Water	0°C~+70°C
Water-based paint (*)	0°C~+40°C

(*) Water-based paint, or aliphatic or aromatic carbon hydride solvent.
☞ Contact us for other operating fluids.

Negative pressure performance

-101.294kPa

Relation between the working temperature and the maximum working pressure

The maximum working pressure varies with the working temperature (environmental temperature). For use at an abnormal temperature, always check the maximum working pressure change in the graph below and keep the pressure within the indicated range.

⚠ Caution Using tubes at a pressure outside the range may cause accidents or damage, for which Nitta is not liable.

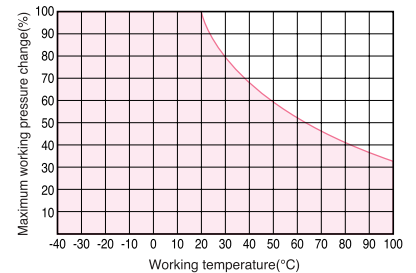

Handling instructions

⚠ Caution When water is used as the operating fluid, the tube material might degrade depending on the additive. Contact us for details.

⚠ Caution When water is used as the operating fluid, keep the surge pressure below the maximum working pressure. Also, do not allow the water to freeze.

☞ See page 10 for common instructions for tube products.

Applicable fittings



(*1) Combinatory use of TES tube and Chemifit series mixes general and clean type performances. When using them in a clean environment, pay attention to the clean level that could be lowered.

Reference

Chemical resistance specification table ...P.207
Effective cross-sectional area ...P.176
Negative-pressure performance list ...P.177

Tube

Clean tube

Processed tube

PushOne fitting

QuickSeal fitting

Clean fitting/ Chemifit

Bamboo-shoot fitting

Control switch/ Detachable series

Jig/Tool/ Accessory

Technical information

Reference

● Comparison of flexibility



Test method

A test tube is placed on a bending strength measurement machine and bent until a kink is created, at which moment the stress is measured.

Test condition

Test temperature: Room temperature
Tube size: 8 x 6

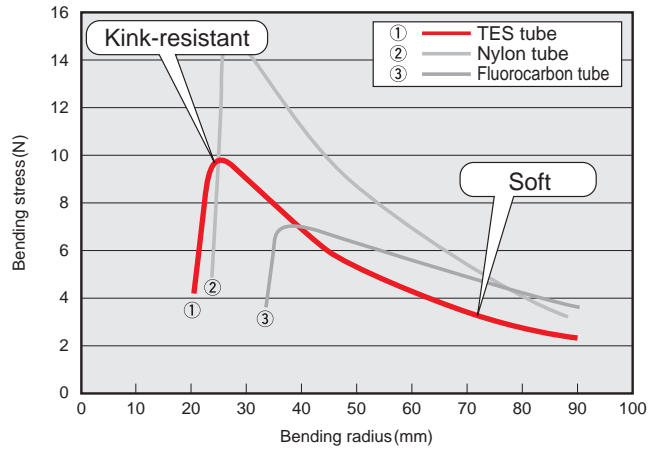
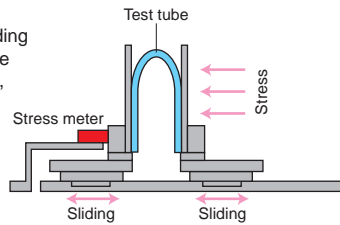

● Abrasion resistance

Test method

A tube suspended from above and a counter tube fixed on a rotating jig are rubbed together.

Test condition

Number of counter tubes: 11
Rotation speed: 60rpm
Number of rotations: 50,000
Weight mass: 500g
Test temperature: Room temperature

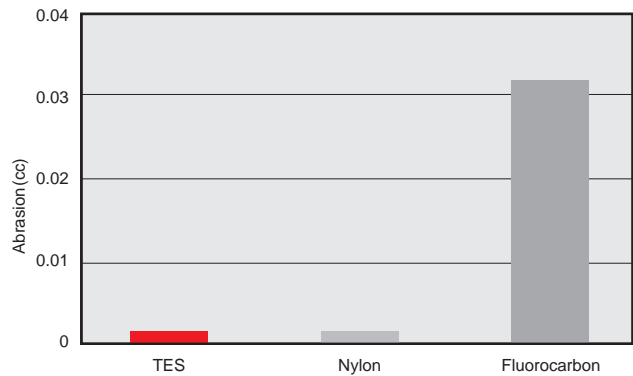
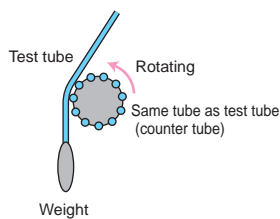

Chemical resistance performance table

Check chemical resistance of each material in Chemical resistance performance table for safe use of Nitta Moore's products.

Criteria ○ =No influence × =Unusable
△ =Sufficient confirmation required

*When contacting us for the criteria △, please check ① working pressure, ② maximum working temperature, ③ concentration, ④ piping status, and ⑤ application.

- The criteria of chemical resistance performance table are made under a certain condition. Therefore the criteria ○ can not ensure safety under a different condition, different environment, and different used period.
- Before using our products, check them under the actual use conditions in your company.
- Unless indicated specifically, test chemicals in the table are used at a saturated concentration and the test temperature is room temperature.
- The table presents the chemical resistance performance of materials, not the permeability of gas chemicals. Do not use chemicals (activated gases) that are hazardous if they permeate a tube.
- When using a QuickSeal series fitting at a high temperature within the working temperature range, tighten the nut periodically. If the nut cannot be tightened further, cut off the tube end and old sleeve and attach the tube again with a new sleeve.

Category	Chemicals	Inner surface (fluorocarbon resin)	Outer surface (nylon)	Category	Chemicals	Inner surface (fluorocarbon resin)	Outer surface (nylon)	Category	Chemicals	Inner surface (fluorocarbon resin)	Outer surface (nylon)
Inorganic acid	Hydrochloric acid (35%)	○	×	Organic acid	Acetic acid	△	×	Amine	Aniline	△	×
	Sulfuric acid (98%)	△	×		Oxalic acid	○	○		Pyridine	○	×
	Nitric acid (25%)	○	×		Citric acid	○	○		Ethylenediamine	△	△
	Phosphoric acid (50%)	○	×		Stearic acid	○	○		Dimethylformamide	△	×
					Formic acid	○	×		Phenol	○	△
Alkali	Caustic soda (10%)	○	△	Trichloroacetic acid	○	×	Benzaldehyde	△	△		
	Caustic potash (10%)	○	△	Lactic acid	○	△	Nitrobenzene	△	△		
	Ammonium hydroxide (15%)	○	△				Benzene	○	△		
Other inorganic substance	Chlorine	△	×	Ester	Ethyl acetate	△	○	Aromatic series	Toluene	○	△
	Bromine	○	×		Butyl acetate	○	○		Xylene	○	△
	Hydrogen peroxide	○	×		Methanol	○	△		Cresol	○	×
	Water	○	○		Ethanol	○	△		Halides	Chloroform	○
Ketone	Acetone	△	△	Propyl alcohol	○	△	Carbon tetrachloride			○	△
	Methyl ethyl ketone	○	△	Hexane	○	○	Trichloroethylene	○		△	
	Methyl isobutyl ketone	○	△	Mineral oil ASTM No.3	○	○	Tetrachloroethylene	○		△	
				Octane	○	○	Ether	Tetrahydrofuran		△	△
			Cyclohexane	○	○	Cellosolve		△	△		

Flame-Resistant Tube

FS

For spot welding piping

Features

- Flame resistant tube with high self-extinguishing performance is compliant with V-0 of UL94 standard
- Super flexible single layer structure
- Marking along the tube as an insertion length indicator



Product number table

● Millimeter size type

Type	Outer diameter × Inner diameter (mm)	Max. working pressure (MPa at 20°C)	Min. bending radius (mm)	Weight (g/m)	Standard color (color symbol)									
					Black	White	Yellow	Blue	Green	Red	Light cream	Light green	Pink	
					BK	WH	YL	BU	GN	RE	LCM	LGN	PK	
FS-4-4×2.5	4×2.5	1.0	10	10	●	○	●	●	●	●	—	—	—	
FS-4-6×4	6×4		15	21	●	○	●	●	●	●	●	—	—	
FS-4-8×5	8×5	1.2	15	40	●	○	●	●	●	●	—	—	—	
*1 FS-4-8×5.5	8×5.5	0.9	20	36	●	○	●	●	●	●	●	—	—	
FS-4-10×6.5	10×6.5	1.0	20	60	●	○	●	●	●	●	—	—	—	
*1 FS-4-10×7	10×7	0.9	25	55	●	○	●	●	●	●	●	●	●	
FS-4-12×8	12×8	1.0	30	82	●	○	●	●	●	●	—	—	—	
*1 FS-4-12×8.5	12×8.5	0.9	30	77	●	○	●	●	●	●	●	●	●	
FS-4-16×12	16×12	0.7	80	106	—	—	—	●	—	—	—	—	—	

*1 Insertion type fittings of QuickSeal series cannot be used for FS tube because of different inner diameters.

*2 Made to Order

Standard length

20M, 100M FS-4-16x12: 50M only

Product number example

FS - 4 - 6×4 - BK - 100M

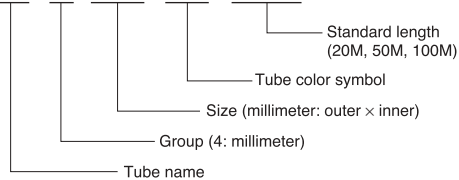

Insertion length marking

Marking along the tube as an insertion length indicator



Operating fluid, working temperature range

Operating fluid	Working temperature range
Air	-40°C~+100°C
Water	0°C~+70°C

Negative pressure performance

-101.294kPa

Relation between the working temperature and the maximum working pressure

The maximum working pressure varies with the working temperature (environmental temperature). For use at an abnormal temperature, always check the maximum working pressure change in the graph below and keep the pressure within the indicated range.

Caution Using tubes at a pressure outside the range may cause accidents or damage, for which Nitta is not liable.

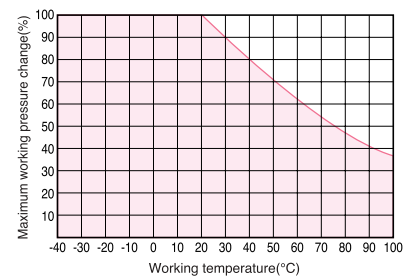

Handling instructions

Caution When water is used as the operating fluid, the tube material might degrade depending on the additive. Contact us for details.

Caution When water is used as the operating fluid, keep the surge pressure below the maximum working pressure. Also, do not allow the water to freeze.

See page 10 for common instructions for tube products.

Applicable fittings



(*1) When QuickSeal series fittings are used on a spatter-resistant line, replace the nylon sleeve with a brass sleeve.

Allied products and product introduction

Spatter cap



P.169

Reference

Flame test of UL-94 standardP.204
 Effective cross-sectional areaP.176
 Negative-pressure performance listP.177

Tube

Clean tube

Processed tube

PushOne fitting

QuickSeal fitting

Clean fitting/Chemifit

Bamboo-shoot fitting

Control switch/Detachable series

Jig/Tool/Accessory

Technical information

Reference

Flame-Resistant Tube

FW

For spot welding piping (bilayer)

Features

- Flame resistant tube with high self-extinguishing performance is compliant with V-0 of UL94 standard
- Bilayer structure with flame-resistant inner and outer layers
- Marking along the tube as an insertion length indicator



Product number table

● Millimeter size type (Group 4)

Type	Inner tube Outer diameter × Inner diameter (mm)	Outer cover Cover thickness	Max. working pressure (MPa at 20°C)	Min. bending radius (mm)	Weight (g/m)	Standard color (color symbol)										
						Inner tube	Outer cover									Greenish white
							Black	White	Yellow	Blue	Green	Red	Light green	Pink	Greenish white	
BK	WH	YL	BU	GN	RE	LGN	PK	GWH								
FW-4-6×4	6×4	1.0	1.0	14	49	●	○	●	●	●	●	○	○	○	○	
FW-4-8×6	8×6	1.0	0.8	23	65	●	○	●	●	●	●	○	○	○	○	
FW-4-10×7.5	10×7.5	1.0		27	89	●	○	●	●	●	●	○	○	○	○	○
FW-4-12×9	12×9	1.0		31	116	●	○	●	●	●	●	○	○	○	○	○

⚠ Caution Before using FW tubes, peel off outer covers.
Use Nitta Moore's special cutter (TC02, TC03) to peel off covers.

Standard length

20M, 100M 📏 FW-4-12x9: 50M only

Product number expression

FW - 4 - 6×4 - BK - 100M

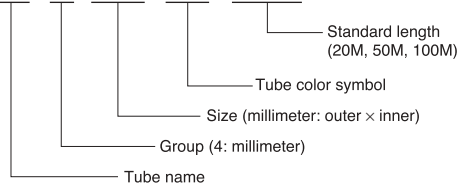

Insertion length marking

Marking along the tube as an insertion length indicator



Operating fluid, working temperature range

Operating fluid	Working temperature range
Air	-40°C~+80°C
Water	0°C~+70°C

Negative pressure performance

-101.294kPa

Relation between the working temperature and the maximum working pressure

The maximum working pressure varies with the working temperature (environmental temperature). For use at an abnormal temperature, always check the maximum working pressure change in the graph below and keep the pressure within the indicated range.

⚠ Caution Using tubes at a pressure outside the range may cause accidents or damage, for which Nitta is not liable.

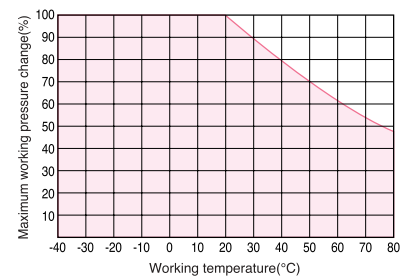

Handling instructions

⚠ Caution When water is used as the operating fluid, the tube material might degrade depending on the additive. Contact us for details.

⚠ Caution When water is used as the operating fluid, keep the surge pressure below the maximum working pressure. Also, do not allow the water to freeze.

📖 See page 10 for common instructions for tube products.

Applicable fittings

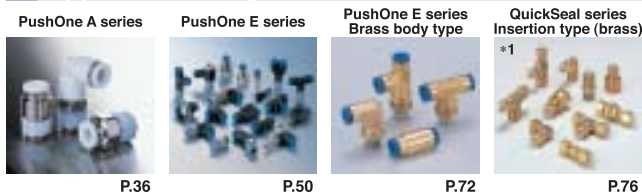

(*1) When QuickSeal series fittings are used on a spatter-resistant line, replace the nylon sleeve with a brass sleeve.

Allied products and product introduction



Reference

UL-94 standard flame testP.204
Effective cross-sectional areaP.176
Negative-pressure performance listP.177

Tube

Clean tube

Processed tube

PushOne fitting

QuickSeal fitting

Clean fitting/Chemifit

Bamboo-shoot fitting

Control switch/Detachable series

Jig/Tool/Accessory

Technical information

Reference

Reference

Flame-Resistant Tube

FWU

For spot welding piping (flexible)

Features

- Flame resistant outer cover with high self-extinguishing performance is compliant with V-0 of UL94 standard
- Bilayer structure with flame-resistant resin outer layer and polyurethane inner layer with higher flexibility than FW
- Ether polyurethane resin is used for the inner layer to prevent degradation by water or mold under high temperature and high humidity.
- Marking along the tube as an insertion length indicator

Product number table

● Millimeter size type (Group 4)

Type	Inner tube Outer diameter × Inner diameter (mm)	Outer cover Cover thickness	Max. working pressure (MPa at 20°C)	Min. bending radius (mm)	Weight (g/m)	Standard color (color symbol)								
						Inner tube	Outer cover							Greenish white
							Black	Red	Blue	Green	Yellow	Light green	Pink	
BK	RE	BU	GN	YL	LGN	PK	GWH							
FWU-4-6×4	6×4	1.0	0.9	14	50	●	—	—	—	—	—	—	—	—
FWU-4-8×5	8×5	1.0		20	73	●	—	—	—	—	—	—	—	—
FWU-4-10×6.5	10×6.5	1.0	0.6	30	98	●	●	●	—	—	●	●	●	●
FWU-4-12×8	12×8	1.0		35	126	●	●	●	●	●	●	●	●	●

⚠ Caution Before using FWU tubes, peel off outer covers.
Use Nitta Moore's special cutter (TC02, TC03) to peel off covers.

Standard length

20M, 100M 📏 FW-4-16x12: 50M only

Product number example

FWU - 4 - 6×4 - BK - 100M

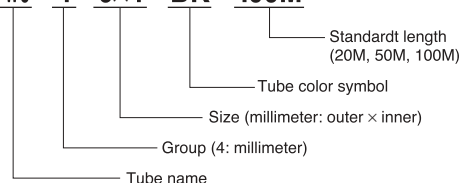

Insertion length marking

Marking along the tube as an insertion length indicator



Operating fluid, working temperature range

Operating fluid	Working temperature range
Air	-40°C~+80°C
Water	0°C~+50°C

Negative pressure performance

-101.294kPa

Relation between the working temperature and the maximum working pressure

The maximum working pressure varies with the working temperature (environmental temperature). For use at an abnormal temperature, always check the maximum working pressure change in the graph below and keep the pressure within the indicated range.

⚠ Caution Using tubes at a pressure outside the range may cause accidents or damage, for which Nitta is not liable.

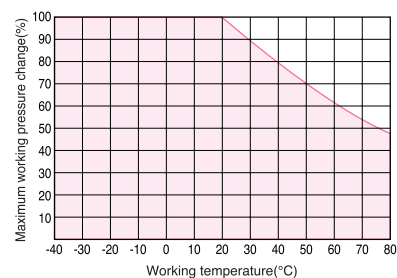

Handling instructions

⚠ Caution When water is used as the operating fluid, the tube material might degrade depending on the additive. Contact us for details.

⚠ Caution When water is used as the operating fluid, keep the surge pressure below the maximum working pressure. Also, do not allow the water to freeze.

📖 See page 10 for common instructions for tube products.

Applicable fittings



(*1) When QuickSeal series fittings are used on a spatter-resistant line, replace the nylon sleeve with a brass sleeve.

Allied products and product introduction



Reference

UL-94 standard flame testP.204
Effective cross-sectional areaP.176
Negative-pressure performance listP.177

Antistatic Tube

UE

For general air pressure (electrically conductive)

Features

- Conductive polyurethane elastomer is used to prevent accumulation of electrostatic and hence spark. (Surface resistance 10^5 - $10^3\Omega$)
- Super flexible

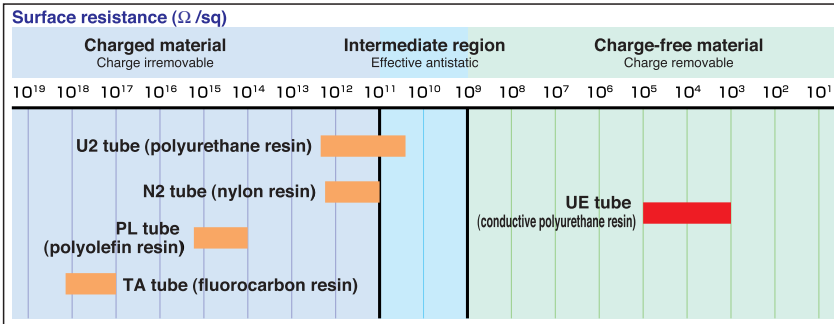

Product number table

● Millimeter size type (Group 4)

Type	Outer diameter × Inner diameter (mm)	Max. working pressure (MPa at 20°C)	Min. bending radius (mm)	Weight (g/m)	Standard color (color symbol)
					Black BK
UE-4-4×2.5	4×2.5	0.8	10	10	●
UE-4-6×4	6×4		15	20	●
UE-4-8×5	8×5		23	39	●
UE-4-10×6.5	10×6.5		30	57	●
UE-4-12×8	12×8		35	79	●

Standard length

20M, 100M

Product number example

UE - 4 - 6×4 - BK - 100M

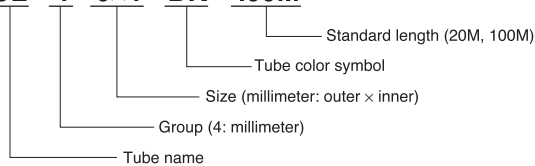

Operating fluid, working temperature range

Operating fluid	Working temperature range
Air	-40°C~+80°C

Negative pressure performance

-101.294kPa

Relation between the working temperature and the maximum working pressure

The maximum working pressure varies with the working temperature (environmental temperature). For use at an abnormal temperature, always check the maximum working pressure change in the graph below and keep the pressure within the indicated range.

⚠ Caution Using tubes at a pressure outside the range may cause accidents or damage, for which Nitta is not liable.

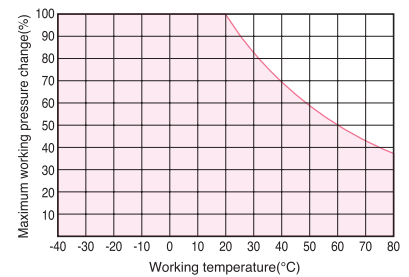

Handling instructions

⚠ Caution When the PushOne series are used with a UE tube, choose a metal type of body including a connector and an internal connector or a brass body type of the PushOne E series to maintain electric conductivity between the tube and the fittings.

📖 See page 10 for common instructions for tube products.

Applicable fittings



(*1) When a PushOne series are used with a UE tube, choose a metal type of body including a connector and an internal connector or a brass body type of the PushOne E series to maintain electric conductivity between the tube and the fittings.

(*2) Combinatory use of UE tube and Chemifit series mixes general and clean type performances. When using them in a clean environment, pay attention to the clean level that could be lowered.

Reference

Effective cross-sectional areaP.176
Negative-pressure performance listP.177

Shape-keeping Tube

DK

For shape keeping and fixed piping that defies clamp

Features

- Aluminum is used for the inner layer for maintaining the shape. Suitable for fixed piping.
- Better workability compared to copper piping if DK fittings are used. Tube end processing is not necessary.



Structure diagram

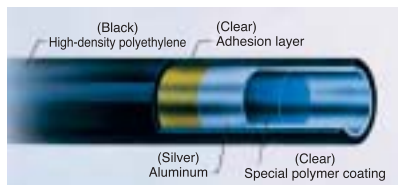

Product number table

● Millimeter size type (Group 4)

Type	Outer diameter × Inner diameter (mm)	Max. working pressure (MPa at 20°C)	Min. bending radius (mm)	Weight (g/m)	Standard color (color symbol)
					Black BK
1300-6	6×4	1.0	20	21	●
1300-10	10×6.8		40	47	●

Standard length

20M, 100M

Product number example

1300 - 6 - BK - 100M

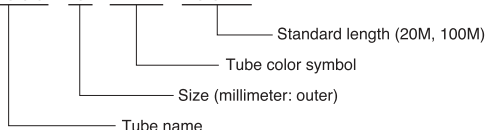

Applicable fittings

QuickSeal series
DK tube dedicated type



P.98

Operating fluid, working temperature range

Operating fluid	Working temperature range
Air	-40°C~+60°C

Negative pressure performance

-101.294kPa

Relation between the working temperature and the maximum working pressure

The maximum working pressure of DK tube does not decrease by temperature as far as within the working temperature (environment temperature) range.

Handling instructions

⚠ Caution DK tube cannot be used for movable applications.

📖 See page 10 for common instructions for tube products.

Reference

Effective cross-sectional areaP.176

Negative-pressure performance listP.177

Tube

Clean tube

Processed tube

PushOne fitting

QuickSeal fitting

Clean fitting/Chemifit

Bamboo-shoot fitting

Control switch/Detachable series

Jig/Tool/Accessory

Technical information

Reference

Polybuten Tube

PB

For food processing machines

Features

- Suitable for piping that requires high temperature antimicrobial cleaning of food processing machines
- Compliant with the MHLW Ministerial Notification No.201(2006), MHW Ministerial Notification No.370(1959), Japan

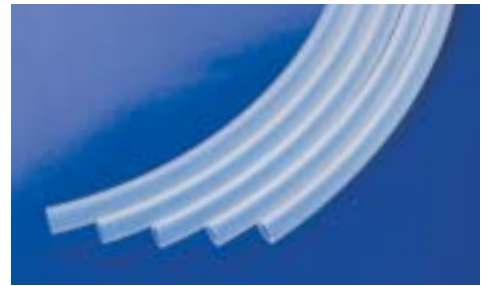

Product number table

● Inch size type

Type	Outer diameter × Inner diameter (mm)	Max. working pressure (MPa at 20°C)	Min. bending radius (mm)	Weight (g/m)	Standard color (color symbol)
					Milky white MW
PB-1-1/4	6.35×4.57	1.1	25	14	○
PB-1-3/8	9.53×6.99		30	30	○
PB-1-1/2	12.70×9.56		40	50	○

Standard length

20M, 100M

Product number example

PB - 1 - 1/4 - MW - 100M

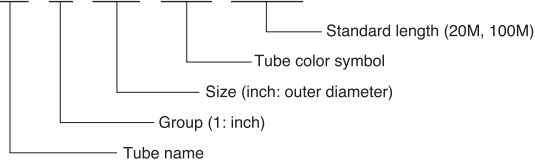

Operating fluid, working temperature range

Operating fluid	Working temperature range
Air	-10°C~+90°C
Water	0°C~+90°C

Negative pressure performance

-101.294kPa

Relation between the working temperature and the maximum working pressure

The maximum working pressure varies with the working temperature (environmental temperature). For use at an abnormal temperature, always check the maximum working pressure change in the graph below and keep the pressure within the indicated range.

⚠ Caution Using tubes at a pressure outside the range may cause accidents or damage, for which Nitta is not liable.

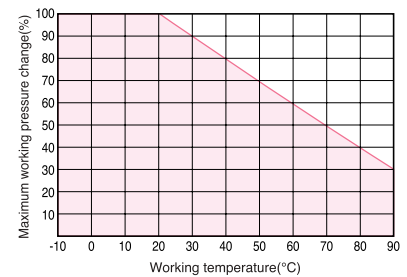

Handling instructions

⚠ Caution When water is used as the operating fluid, the tube material might degrade depending on the additive. Contact us for details.

⚠ Caution When water is used as the operating fluid, keep the surge pressure below the maximum working pressure. Also, do not allow the water to freeze.

📖 See page 10 for common instructions for tube products.

Applicable fittings

QuickSeal series
Insertion type (brass)



P.76

QuickSeal series
Insertion type (stainless)



P.88

Chemifit CSA series



P.118

Chemifit CS series



P.126

(*1) Combinatory use of PB tube and Chemifit series mixes general and clean type performances. When using them in a clean environment, pay attention to the clean level that could be lowered.

Reference

Chemical resistance specification tableP.207
Effective cross-sectional areaP.176
Negative-pressure performance listP.177

Tube

Clean tube

Processed tube

PushOne fitting

QuickSeal fitting

Clean fitting/ Chemifit

Bamboo-shoot fitting

Control switch/ Detachable series

Jig/Tool/ Accessory

Technical information

Reference

Polyolefin Resin Tube

PL

For clean piping (flexible)

Features

- A clean tube suitable for equipment and applications with fluids such as clean air, N₂ gas, pure water and various chemical liquids
- Environment-friendly eco tube. When burned at 750°C, PL tube generates only carbon dioxide gas, no nitrogen oxides (NO_x), no sulfur oxides (SO_x), and absolutely no dioxin.
- Produced, end-sealed, heat-sealed for shipping in a cleanroom
- Made of special polyolefin resin with high water barrier performance and flexibility
- Low cost compared to fluorocarbon resin tubes
- Compliant with the MHLW Ministerial Notification No.201(2006), MHW Ministerial Notification No.370(1959), Japan



Operating fluid, working temperature range

Operating fluid	Working temperature range
Air (clean air)	-60°C~+80°C
Water (pure water)	0°C~+80°C

Contact us for various chemical liquids.
See "Combination List of Tube and Fitting" on page 8.

Negative pressure performance

-101.294kPa

Relation between the working temperature and the maximum working pressure

The maximum working pressure varies with the working temperature (environmental temperature). For use at an abnormal temperature, always check the maximum working pressure change in the graph below and keep the pressure within the indicated range.

Caution Using tubes at a pressure outside the range may cause accidents or damage, for which Nitta is not liable.

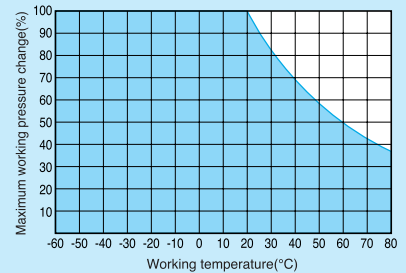

Handling instructions

Caution When water is used as the operating fluid, the tube material might degrade depending on the additive. Contact us for details.

Caution When water is used as the operating fluid, keep the surge pressure below the maximum working pressure. Also, do not allow the water to freeze.

See page 10 for common instructions for tube products.

Product number table

● Millimeter size type (Group 4)

Type	Outer diameter × Inner diameter (mm)	Max. working pressure (MPa at 20°C)	Min. bending radius (mm)	Weight (g/m)	Standard color (color symbol)					
					Black	Milky white	Red	Blue	Yellow	Green
					BK	MW	RE	BU	YL	GN
PL-4-4×2	4×2	1.5	15	10	●	○	●	●	●	●
PL-4-6×4	6×4	1.0	25	15	●	○	●	●	●	●
PL-4-8×6	8×6	0.7	35	20	●	○	●	●	●	●
PL-4-10×7.5	10×7.5		45	30	—	○	—	—	—	—
PL-4-10×8	10×8	0.5	45	25	●	○	●	●	●	●
PL-4-12×9	12×9	0.7		45	45	●	○	●	●	●

● Inch size type (Group 1)

Type	Outer diameter × Inner diameter (mm)	Max. working pressure (MPa at 20°C)	Min. bending radius (mm)	Weight (g/m)	Standard color (color symbol)					
					Black	Milky white	Red	Blue	Yellow	Green
					BK	MW	RE	BU	YL	GN
PL-1-1/4	6.35×4.57	0.7	30	14	●	○	●	●	●	●
PL-1-3/8	9.53×6.99		40	30	●	○	●	●	●	●
PL-1-1/2	12.70×9.56		55	50	●	○	●	●	●	●

● Inch size type (Group 5)

Type	Outer diameter × Inner diameter (mm)	Outer diameter	Max. working pressure (MPa at 20°C)	Min. bending radius (mm)	Weight (g/m)	Standard color (color symbol)	
						Milky white	MW
PL-5-3.18×2	3.18×2	1/8	0.9	7	4	○	

Applicable fittings for Group 5 are Chemifit C1 series and Chemifit C1S series with the same outer diameter.

Product number example

PL - 4 - 6×4 - BK - 100M

Standard length

20M, 100M

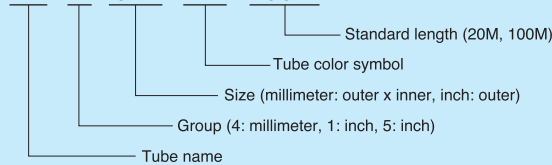

Applicable fittings

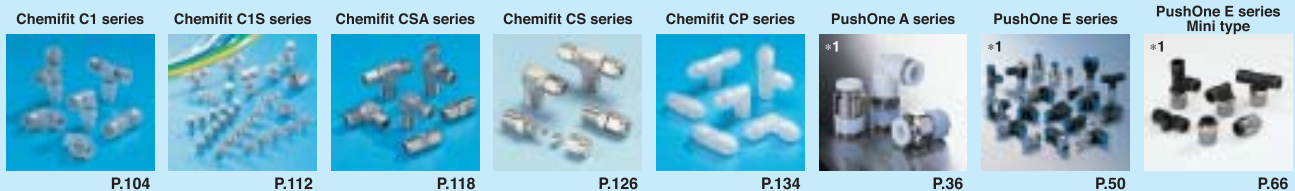

Applicable fittings

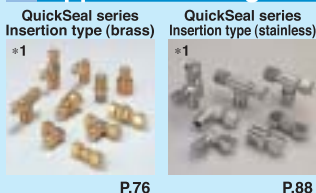

Allied products and product introduction



Reference

Chemical resistance specification tableP.207
Effective cross-sectional areaP.176
Negative-pressure performance listP.177

(*1) Combinatory use of PL tube and Chemifit series mixes general and clean type performances. When using them in a clean environment, pay attention to the clean level that could be lowered.

PN

For clean piping (Super flexible)

Features

- A clean tube suitable for equipment and applications with fluids such as clean air, N2 gas, pure water and various chemical liquids
- Environment-friendly eco tube. When burned at 750°C, PL tube generates only carbon dioxide gas, no nitrogen oxides (NOx), no sulfur oxides (SOx), and absolutely no dioxin.
- Produced, end-sealed, heat-sealed for shipping in a cleanroom
- Made of special polyolefin resin with high water barrier performance and higher flexibility than PL tubes
- Low cost compared to fluorocarbon resin tubes
- Compliant with the MHLW Ministerial Notification No.201(2006), MHW Ministerial Notification No.370(1959), Japan

Product number table

● Millimeter size type (Group 4)

Type	Outer diameter × Inner diameter (mm)	Max. working pressure (MPa at 20°C)	Min. bending radius (mm)	Weight (g/m)	Standard color (color symbol)				
					Milky white	Clear red	Clear blue	Clear yellow	Clear green
					MW	CR	CB	CY	CGN
PN-4-3×2	3×2	0.7	10	7	○	—	—	—	—
PN-4-4×2.5	4×2.5				○	—	—	●	●
PN-4-6×4	6×4		○	—	—	●	●		
PN-4-8×5	8×5		○	●	●	●	●		
PN-4-10×6.5	10×6.5		○	—	●	●	●		
PN-4-12×8	12×8		○	—	●	—	—		

Standard length

20M, 100M

Product number example

PN - 4 - 6×4 - MW - 100M

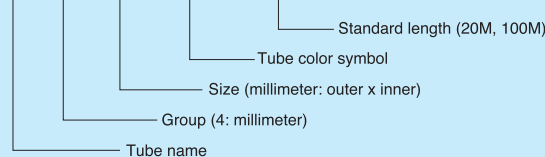

Operating fluid, working temperature range

Operating fluid	Working temperature range
Air (clean air)	-60°C~+80°C
Water (pure water)	0°C~+80°C

- ☞ Contact us for various chemical liquids.
- ☞ See "Combination List of Tube and Fitting" on page 8.

Negative pressure performance

-101.294kPa

Relation between the working temperature and the maximum working pressure

The maximum working pressure varies with the working temperature (environmental temperature). For use at an abnormal temperature, always check the maximum working pressure change in the graph below and keep the pressure within the indicated range.

⚠ Caution Using tubes at a pressure outside the range may cause accidents or damage, for which Nitta is not liable.

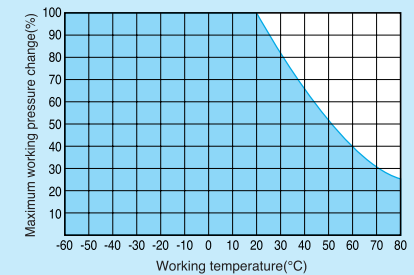

Handling instructions

- ⚠ Caution When water is used as the operating fluid, the tube material might degrade depending on the additive. Contact us for details.
- ⚠ Caution When water is used as the operating fluid, keep the surge pressure below the maximum working pressure. Also, do not allow the water to freeze.

☞ See page 10 for common instructions for tube products.

Applicable fittings

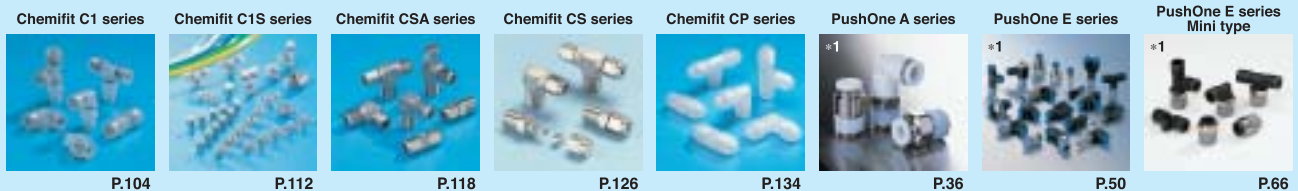

Applicable fittings

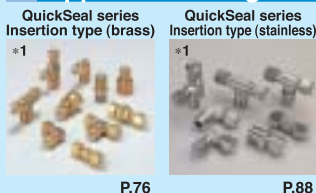

Allied products and product introduction

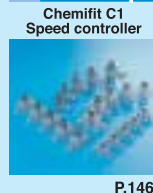

Reference

- Chemical resistance specification tableP.207
- Effective cross-sectional areaP.176
- Negative-pressure performance listP.177

(*) Combinatory use of PN tube and Chemifit series mixes general and clean type performances. When using them in a clean environment, pay attention to the clean level that could be lowered.

Fluorocarbon Resin Tube

TA

For clean, heat-resistant, cold-resistant, chemical-resistant use

Features

- PFA (copolymer of tetrafluoroethylene – perfluoroalkyl vinyl ether) resin tube with high chemical resistance
- Produced, end-sealed, heat-sealed for shipping in a cleanroom
- Easy cleaning with little remaining fluid inside
- Little secular change and high weather resistance
- Usable in ozone environment
- Usable for clean fittings of Chemifit CSA series
- Compliant with the MHLW Ministerial Notification No.201(2006), MHW Ministerial Notification No.370(1959), Japan

Product number table

● Millimeter size type (Group 4)

Type	Outer diameter × Inner diameter (mm)	Max. working pressure (MPa at 20°C)	Min. bending radius (mm)	Weight (g/m)	Standard color (color symbol)	
					Translucent	CWH
TA-4-3×2	3×2	1.5	20	8.5		○
TA-4-4×2	4×2	2.5	25	20		○
TA-4-4×3	4×3	0.9	30	12		○
TA-4-6×4	6×4	1.6	30	34		○
TA-4-8×6	8×6	1.1	50	47		○
TA-4-10×8	10×8	0.8	70	61		○
TA-4-12×9	12×9	1.1	70	106		○
TA-4-12×10	12×10	0.7	100	74		○
* TA-4-14×12	14×12	0.6	150	89		○
* TA-4-17×14	17×14	0.7	300	159		○
TA-4-19×16	19×16	0.6	400	179		○
* TA-4-24×20	24×20		500	300		○
* TA-4-25×22	25×22	0.5	600	240		○

*Made to Order

● Inch size type (Group 1)

Type	Outer diameter × Inner diameter (mm)	Max. working pressure (MPa at 20°C)	Min. bending radius (mm)	Weight (g/m)	Standard color (color symbol)	
					Translucent	CWH
TA-1-1/4	6.35×4.57	1.1	30	33		○
TA-1-3/8	9.53×6.99	1.1	50	71		○
TA-1-1/2	12.70×9.56	1.1	60	118		○

● Inch size type (Group 5) Different inner diameter from Group 1

Type	Outer diameter × Inner diameter (mm)	Outer diameter	Max. working pressure (MPa at 20°C)	Min. bending radius (mm)	Weight (g/m)	Standard color (color symbol)	
						Translucent	CWH
TA-5-3.18×2	3.18×2	1/8	1.5	7	10		○
TA-5-6.35×3.96	6.35×3.96	1/4	1.7	45	42		○
TA-5-9.53×6.35	9.53×6.35	3/8	1.5	60	86		○
TA-5-12.7×9.53	12.70×9.53	1/2	1.1	90	120		○
* TA-5-19.1×15.9	19.10×15.9	3/4	0.6	400	186		○
* TA-5-25.4×22.2	25.40×22.2	1	0.5	600	240		○

☞ Applicable fittings for Group 5 are Chemifit C1 series and Chemifit C1S series with the same outer diameter.

*Made to Order

Product number example

TA-4-6×4-CWH-100M

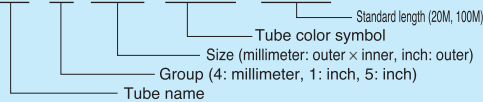

Standard length

20M, 100M

☞ TA-4- 14×12, 17×14, 19×16, 24×20, 25×22 and TA-5- 19.1×15.9, 25.4×22.2: 20M only



Operating fluid, working temperature range

Operating fluid	Working temperature range
Air (clean air)	-65°C~+260°C
Water (pure water)	0°C~+100°C

☞ Contact us for various chemical liquids.

☞ See "Combination List of Tube and Fitting" on page 8.

Negative pressure performance

-101.294kPa

Relation between the working temperature and the maximum working pressure

The maximum working pressure varies with the working temperature (environmental temperature). For use at an abnormal temperature, always check the maximum working pressure change in the graph below and keep the pressure within the indicated range.

⚠ Caution Using tubes at a pressure outside the range may cause accidents or damage, for which Nitta is not liable.

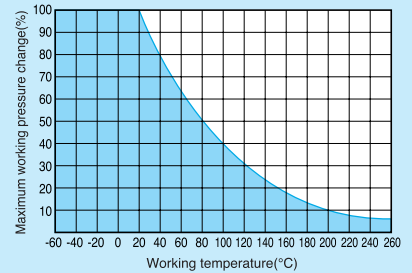

Handling instructions

⚠ Caution When water is used as the operating fluid, keep the surge pressure below the maximum working pressure. Also, do not allow the water to freeze.

☞ See page 10 for common instructions for tube products.

Applicable fittings

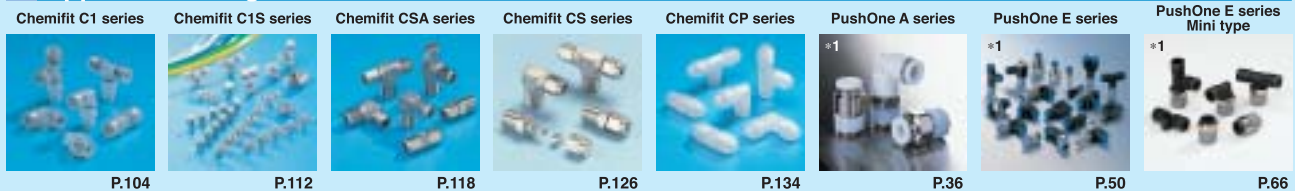

Applicable fittings



Allied products and product introduction

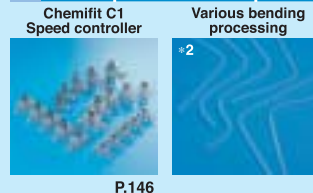

Products with high-graded PFA material are available on request. Contact us for details.

Reference

Chemical resistance specification tableP.207
Effective cross-sectional areaP.176
Negative-pressure performance listP.177

(*1) Combinatory use of TA tube and Chemifit series mixes general and clean type performances. When using them in a clean environment, pay attention to the clean level that could be lowered.
(*2) Contact us for specifications.

Fluorocarbon Resin Tube

TP

For clean, heat-resistant, cold-resistant, chemical-resistant use

Features

- FEP (copolymer of tetrafluoroethylene – hexafluoropropylene) resin tube with high chemical resistance
- Produced, end-sealed, heat-sealed for shipping in a cleanroom
- Easy cleaning with extremely little remaining fluid inside
- Usable for clean fittings of Chemifit C1 series
- Little secular change and high weather resistance
- Usable in ozone environment
- Compliant with the MHLW Ministerial Notification No.201(2006), MHW Ministerial Notification No.370(1959), Japan

Product number table

● Millimeter size type (Group 4)

Type	Outer diameter × Inner diameter (mm)	Max. working pressure (MPa at 20°C)	Min. bending radius (mm)	Weight (g/m)	Standard color (color symbol)	
					Translucent	CWH
TP-4-4×2	4×2	2.5	15	20	○	
TP-4-4×2.5	4×2.5	1.7	30	17	○	
TP-4-6×4	6×4	1.6	25	34	○	
TP-4-8×6	8×6	1.1	40	47	○	
TP-4-10×8	10×8	0.8	60	61	○	
TP-4-12×9	12×9	1.1		106	○	
TP-4-12×10	12×10	0.7	90	74	○	
* TP-4-14×12	14×12	0.6	150	89	○	
* TP-4-21×18	21×18	0.6	500	200	○	

*Made to Order

● Inch size type (Group 1)

Type	Outer diameter × Inner diameter (mm)	Max. working pressure (MPa at 20°C)	Min. bending radius (mm)	Weight (g/m)	Standard color (color symbol)	
					Translucent	CWH
TP-1-3/16	4.76×3.48	1.1	20	18	○	
TP-1-1/4	6.35×4.57		30	33	○	
TP-1-5/16	7.94×5.90		40	48	○	
TP-1-3/8	9.53×6.99		50	71	○	
TP-1-1/2	12.70×9.56		60	118	○	

Product number example

TP - 4 - 6×4 - CWH - 100M

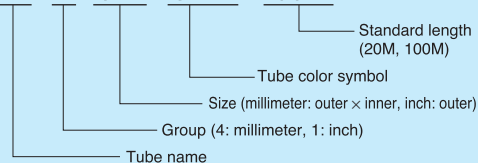

Standard length

20M, 100M
 ☞ TP-4-14×12,
 TP-4-21×18: 20M only



Operating fluid, working temperature range

Operating fluid	Working temperature range
Air (clean air)	-65°C~+200°C
Water (pure water)	0°C~+100°C

- ☞ Contact us for various chemical liquids.
- ☞ See "Combination List of Tube and Fitting" on page 8.

Negative pressure performance

-101.294kPa

Relation between the working temperature and the maximum working pressure

The maximum working pressure varies with the working temperature (environmental temperature). For use at an abnormal temperature, always check the maximum working pressure change in the graph below and keep the pressure within the indicated range.

⚠ Caution Using tubes at a pressure outside the range may cause accidents or damage, for which Nitta is not liable.

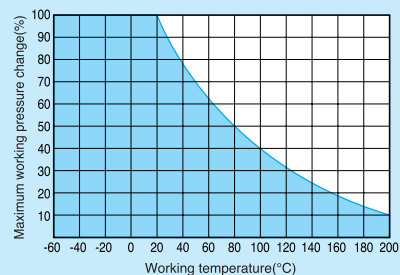









Handling instructions

⚠ Caution When water is used as the operating fluid, keep the surge pressure below the maximum working pressure. Also, do not allow the water to freeze.

☞ See page 10 for common instructions for tube products.

Applicable fittings

 P.104	 P.112	 P.134	 P.36	 P.50	 P.66	 P.72	 P.76
--	--	--	---	---	--	---	---



Applicable fittings

QuickSeal series Insertion type (stainless)



P.88

Allied products and product introduction

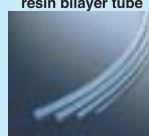
 P.146	 *2	 P.18
--	---	---

Reference

Chemical resistance specification tableP.207
 Effective cross-sectional areaP.176
 Negative-pressure performance listP.177

(*1) Combinatory use of TP tube and Chemifit series mixes general and clean type performances. When using them in a clean environment, pay attention to the clean level that could be lowered.
 (*2) Contact us for specifications.

Polyurethane Coil Tube

UC/USC/UMC

Features

- Polyurethane tubes U2 are coiled.
- USC has a smaller coil diameter than UC.
- UMC is a coil tube with multiple tubes welded for multi piping.



Standard products

UC

Product number	Outer diameter × Inner diameter (mm)	Coil size (mm)			Max. working pressure (MPa at 20°C)	Max. stretchable length (m)	Weight (g/m)	Coiling direction	Standard color
		A	B	C					
UC-6	6×4	240	200	35	0.8	2.5	80	Right	Blue
UC-8	8×5	300		42					
UC-10	10×6.5		52						

☞ Other tube colors are available on request.

USC (small coil diameter type)

Product number	Outer diameter × Inner diameter (mm)	Coil size (mm)			Max. working pressure (MPa at 20°C)	Max. stretchable length (m)	Weight (g/m)	Coiling direction	Standard color
		A	B	C					
USC-4	4×2.5	230	100	18	0.8	1.5	24	Left	Blue
USC-6	6×4	360		24					
USC-8	8×5			31					
USC-10	10×6.5	40			2.0		106		Blue
							172		Blue

☞ Other tube colors are available on request.

UMC (multi-coil type)

Product number	Number of tubes	Outer diameter × Inner diameter (mm)	Coil size (mm)			Max. working pressure (MPa at 20°C)	Max. stretchable length (m)	Weight (g/m)	Standard color combination	
			A	B	C					
UMC602	A B	6×4	350	100	40	0.8	1.5	114	Blue, Green, Yellow, Red, Black, White	
UMC603	A B									3
UMC604										4
UMC606										6
UMC802	A B	8×5		56			1.5	230	Blue, Green, Yellow, Red, Black, White	
UMC803	A B									3

☞ Other tube colors are available on request.

Nominal lengths

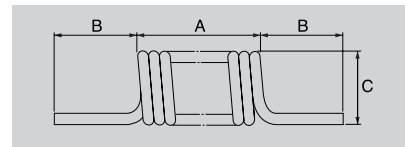

A: Total length of coiled part

B: Length of straight part

C: Outer coil diameter

Operating fluid, working temperature range

Operating fluid	Working temperature range
Air	-40°C~+80°C

Negative pressure performance

-101.294kPa

Relation between the working temperature and the maximum working pressure

The maximum working pressure varies with the working temperature (environmental temperature). For use at an abnormal temperature, always check the maximum working pressure change in the graph below and keep the pressure within the indicated range.

⚠ Caution Using tubes at a pressure outside the range may cause accidents or damage, for which Nitta is not liable.

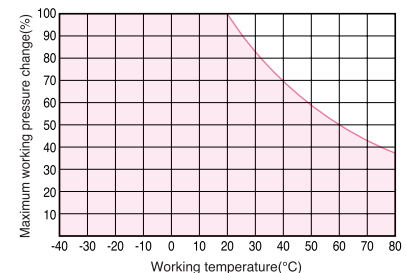

☞ See page 10 for common instructions for tube products.

Applicable fittings

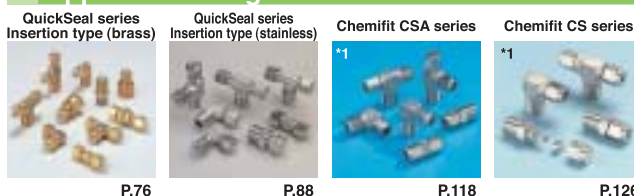

P.76

P.88

P.118

P.126

(*1) Combinatory use of polyurethane coil tube and Chemifit series mixes general and clean type performances. When using them in a clean environment, pay attention to the clean level that could be lowered.

Allied products and product introduction

Tool balancer Q.D.C. 101 series



P.160

Polyurethane Multi-line Tube

UML

Features

- Multiple Polyurethane tubes U2 are welded together.



Product number table

● Millimeter size type

Product number	Outer diameter × Inner diameter (mm)	Max. working pressure (MPa at 20°C)	Min. bending radius	Weight (g/m)	Standard color combination		
UML-402	4×2.5	0.8	10	18	●●●●		
UML-403				27	●●●●		
UML-404				36	●●●●		
UML-406				54	●●●●		
UML-602	6×4		0.8	15	38	●●●●	
UML-603					57	●●●●	
UML-604					76	●●●●	
UML-606					114	●●●●	
UML-802	8×5			0.8	23	70	●●●●
UML-803						105	●●●●

Standard length

5M

Applicable fittings



(*1) Combinatory use of polyurethane multiline tube and Chemifit series mixes general and clean type performances. When using them in a clean environment, pay attention to the clean level that could be lowered.

Operating fluid, working temperature range

Operating fluid	Working temperature range
Air	-40°C~+80°C

Negative pressure performance

-101.294kPa

Relation between the working temperature and the maximum working pressure

The maximum working pressure varies with the working temperature (environmental temperature). For use at an abnormal temperature, always check the maximum working pressure change in the graph below and keep the pressure within the indicated range.

⚠ Caution Using tubes at a pressure outside the range may cause accidents or damage, for which Nitta is not liable.

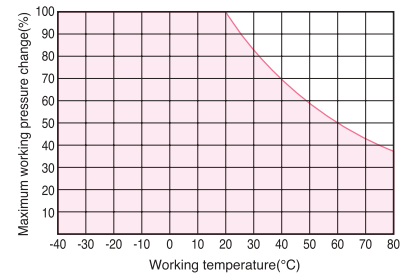

👉 See page 10 for common instructions for tube products.

Tube

Clean tube

Processed tube

PushOne fitting

QuickSeal fitting

Clean fitting/ Chemifit

Bamboo-shoot fitting

Control switch/ Detachable series

Jig/Tool/ Accessory

Technical information

Reference

Nylon Coil Tube

S

Features

- Coil tube with strong restoring force easily returns from stretched form.
- High pressure resistance and heat resistance

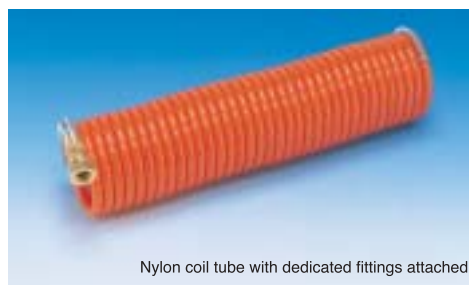

Nylon coil tube with dedicated fittings attached

Standard products

A tube of original length 30M is coiled.

Product number	Outer diameter × Inner diameter (mm)	Max. working pressure (MPa at 20°C)	Length of coil part	Max. stretchable length (mm)	Outer coil diameter (mm)	Weight (g/m)	Standard color (color symbol) Orange(OR)
S3/16-OR-30M	5.95× 4.76	1.2	1170	21	55	0.38	●
S1/4-OR-30M	7.85× 6.35		1120	20	75	0.60	●
S3/8-OR-30M	11.80× 9.53		1210	19	105	1.25	●
S1/2-OR-30M	15.87×12.70		1090	18	155	2.55	●
S3/4-OR-30M	22.80×19.05		690	19.5	360	3.80	●

Product number example

S1/4-OR-30M

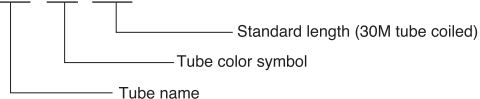

Applicable fittings

QuickSeal series Nylon coil tube dedicated type



P.102

Allied products and product introduction

Q.D.C. 101 series



P.160

Operating fluid, working temperature range

Operating fluid	Working temperature range
Air	-40°C~+100°C

Negative pressure performance

-101.294kPa

Relation between the working temperature and the maximum working pressure

The maximum working pressure varies with the working temperature (environmental temperature). For use at an abnormal temperature, always check the maximum working pressure change in the graph below and keep the pressure within the indicated range.

⚠ Caution Using tubes at a pressure outside the range may cause accidents or damage, for which Nitta is not liable.

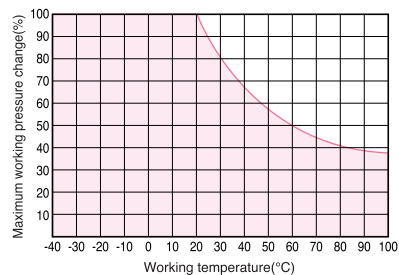

📖 See page 10 for common instructions for tube products.

Tube

Clean tube

Processed tube

PushOne fitting

QuickSeal fitting

Clean fitting/Chemifit

Bamboo-shoot fitting

Control switch/Detachable series

Jig/Tool/Accessory

Technical information

Reference

Multi-pack Tube

1213

(Made-to-order)

Features

- Processed tube for multi piping of up to 19 nylon tubes (N2 tubes) of $\phi 6$ being bundled.

Structure diagram

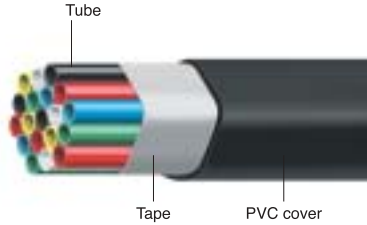

Operating fluid, working temperature range

Bundle tube	N2
Operating fluid	Air
	-40°C~+100°C

Negative pressure performance

-101.294kPa

Relation between the working temperature and the maximum working pressure

The maximum working pressure varies with the working temperature (environmental temperature). For use at an abnormal temperature, always check the maximum working pressure change in the graph below and keep the pressure within the indicated range.

Caution Using tubes at a pressure outside the range may cause accidents or damage, for which Nitta is not liable.

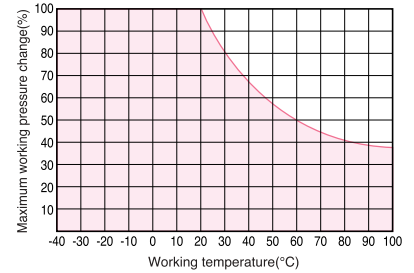

See page 10 for common instructions for tube products.

Product number table (made-to-order)

- N2-4-6×4 (Color: Choose from standard colors of N2 tube)

Product number	Number of tubes	Max. outer diameter (mm)	Cover thickness (mm)	Max. working pressure (MPa at20°C)	Min. bending radius (mm)	Max. allowable tensile strength (N)	Max. bundle sectional area (mm ²)	Weight (g/m)
1213-0602	2	16	1.6	3.0	40	400	122	130
1213-0603	3	16			40	500	165	173
1213-0604	4	20			60	600	208	194
1213-0605	5	22			60	750	251	230
1213-0607	7	22			75	850	326	267
1213-0608	8	25			95	1050	369	298
1213-0610	10	28			100	1150	443	348
1213-0612	12	28			110	1350	518	390
1213-0614	14	31			130	1500	592	443
1213-0619	19	34			150	1900	765	567

Minimum length for order

95M

Applicable fittings for 1213



Tube

Clean tube

Processed tube

PushOne fitting

QuickSeal fitting

Clean fitting/ChemiFit

Bamboo-shoot fitting

Control switch/Detachable series

Jig/Tool/Accessory

Technical information

Reference

FITTING

TUBE FITTING

Handling instructions for fitting products

⚠ Safety Note

This Safety Note provides indications on the correct use of the product in order to prevent harm to people and property. The indications are classified into three categories, "danger", "warning", and "caution", depending on the level of potential harm due to improper use. Each category contains important instructions on safety that should be followed in addition to the latest ISO 4414(*1), JIS B 8370(*2), ISO4413 (*3), and JIS B 8361 (*4).

*1 ISO4414 Pneumatic fluid power...Recommendations for the application of equipment to transmission and control systems.

*2 JIS B 8370 Pneumatic System General Rules

*3 ISO4413 Hydraulic fluid power...General rules for the application of equipment to transmission and control systems.

*4 JIS B 8361 Hydraulic System General Rules



DANGER

Where inappropriate use of this equipment may cause death or severe injury and where immediate warning of a dangerous situation is highly required..



WARNING

Where inappropriate use of this equipment may cause death or severe injury.



CAUTION

Where inappropriate use of this equipment may cause minor injury.

⚠ Before Selection

⚠ DANGER

•Cannot use for machines or equipment for life support.

•To use for machines or equipment that require extremely high safety, measures have to be taken to prevent danger in case of pulling out, burst and leakage.

⚠ WARNING

•Please contact us before using our products under conditions other than those specified in the catalog.

•Please contact us when using our products for equipment, machines, various types of vehicles, and passenger aircraft, for leisure machines or passenger transport, for medical equipment that would cause human harm in case the specifications are inappropriately followed, and for machines in contact with food or drinking water.

⚠ When Selecting

⚠ WARNING

•Please check that our products are used under the "use conditions" specified in the catalog.

•Do not use our products when a caustic or flammable gas is used as the fluid or is in the environment.

⚠ CAUTION

•Do not use our products in places where excessive vibration or impact may occur.

•If use conditions differ between tube and fitting, use them under the lower specified conditions.

•For Nitta's fitting products, use tube products that Nitta specifies or JIS B 8381-1995 on-spec products.

•When a chemical is used in fluid or the environment, see "Chemical resistance specification table". Contact us for chemical resistance of plating.

•When spatter (hot wasted metal) is likely to cling to fittings, use flame-resistant products only. Otherwise spatter may cause fire.

•Chemifit C1 series fitting comes with resin thread and the maximum working pressure varies with the working temperature. See "Relation between the working temperature and the maximum working pressure" when selecting.

⚠ Installation

⚠ WARNING

•Fix tubes when installing them in a place where unexpected disconnection of the tube and connector could cause harm to people or property.

⚠ CAUTION

•Instructions for connecting fittings are given in a separated document. Please read it and follow the instructions to install.

•Do not throw or drop fittings. The impact may cause internal damage even if no outer damage is found.

•Because the connection part of the fitting may swell or crack depending on the material, check the strength of the part when connecting.

•Fitting with a sealing processed thread may swell due to the action of an operating fluid such as organic solvent, allowing fluid leakage from the thread part.

•Prevent sharply bending the piping near the tube insertion port of fitting. Keep the tube straight twice as long as the tube diameter from the insertion port.

•Do not use a fitting with a damaged thread or a damaged tube insertion port. Before using re-usable products, always check that they are undamaged.

•Nitta only guarantees products fabricated by designated companies.

•Prevent tension when installing tubes.

•When using water as the operating fluid for PushOne series, Chemifit C1 series and Chemifit C1S series, prevent installation to a movable place.

•You cannot re-use sleeves of the QuickSeal series and the Chemifit CS series. Replace them with new sleeves each time you detach.

•You cannot re-use the sleeve and the nut of the Chemifit CP series. Replace them with a new sleeve each time you detach.

⚠ Usage

⚠ WARNING

•Nitta's products should be handled only by designers who have sufficient knowledge of equipment, instruments and systems in which our products are to be installed, or by persons responsible for determining specifications. Test and analysis should be conducted if necessary. The designers or the responsible persons are liable for the performance and the safety of the equipment, instruments and systems.

⚠ CAUTION

•When water is used as fluid, do not allow it to freeze.

•Do not touch a tube at pressurization. Improperly treating or touching a tube at pressurization may lead to danger from unexpected breakage or leakage of fluid.

•Do not touch a tube when the operating fluid is hot. Doing so may cause burns.

⚠ Storage

⚠ CAUTION

•When storing unused products, make sure to keep them in a clean place to prevent dust. When fine particles such as dust enter the inside of tube products or the connected equipment, they may cause problems.

•Keep tube products in a dry place below 40°C avoiding direct sunlight.

•Do not use tube products that have been stored for more than one year after production.

•The packaging of clean tubes should be opened just before use. Store the tubes in a box in a clean place in a dust-free environment.

⚠ Maintenance and Inspection

⚠ CAUTION

•Before handling or removing Nitta Moore's products, be sure to check the safety by shutting off power supply, stopping pressure supply, evacuating pressurized air in the pipe, and terminating the operation of equipment, instruments, and systems.

•Please be sure to make periodic inspection. Confirm that there is no degradation such as outer damage, corrosion, and abrasion and replace any damaged piping.

•When using QuickSeal and Chemifit CP series continuously for a long time, or when using them continuously at a high temperature within the working temperature range, tighten their nuts periodically. Also if using a fitting with a resin thread, tighten the thread periodically.

⚠ Disposal

⚠ CAUTION

•Dispose of unnecessary products as industrial waste or have them disposed of by a waste disposal firm. In particular, incineration of products containing fluorocarbon may generate a toxic pyrolysis gas.

FITTING INDEX

PushOne® A series

For general air pressure



P.36

PushOne® E series

For general air pressure



P.50

PushOne® E series

For general air pressure

Mini type



P.66

For general air pressure

Brass body type



P.72

QuickSeal series

For multi-purpose piping

Insertion type
(brass)



P.76

For multi-purpose piping

Insertion type
(stainless)



P.88

For general air pressure

Insertless type



P.94

QuickSeal series

For general air pressure

DK tube dedicated
type



P.98

For general air pressure

Nylon coil tube dedicated
type



P.102

Chemifit® C1 series

For clean air, pure water, chemical liquid piping



P.104

Chemifit® C1S series

For clean air, pure water, chemical liquid piping



P.112

Chemifit® CSA series

For clean air, pure water, chemical liquid piping



P.118

Chemifit® CS series

For clean air, pure water, chemical liquid piping



P.126

Chemifit® CP series

For clean air, pure water, chemical liquid piping



P.134

Bamboo-shoot fitting series

Bamboo-shoot fitting



P.140

Tube

Clean tube

Processed
tube

PushOne
fitting

QuickSeal
fitting

Clean fitting/
Chemifit

Bamboo-
shoot fitting

Control switch/
Detachable
series

Jig/Tool/
Accessory

Technical
information

Reference

PushOne® A Series

PushOne® fittings for general air pressure (flame resistant)

Features

- **PushOne® connection of tube**
The tubes can be connected without using a jig or tools
- **Electroless nickel plated**
Preventing degradation of surface and dissolution of copper ions in fluid
- **White body illuminative to working environment**
- **Flame-resistant resin (compliant V-0 of UL94 standard)**
Made of flame-resistant resin PBT. High self-extinguishing performance is compliant with V-0 of UL94 standard. Usable under an environment with spatters.
- **Sealing-processed R thread.**
Sealing tape is not required.



Cross-sectional structure diagram

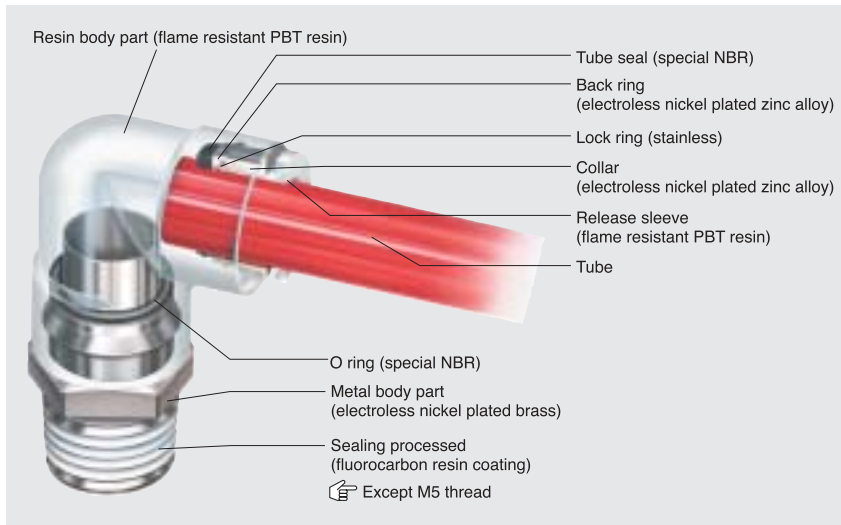

Operating fluid, working temperature range

Operating fluid	Working temperature range
Air	-20°C~+80°C
Water	0°C~+40°C

See "Combination List of Tube and Fitting" on page 8.

Pressure condition

Maximum working pressure: 1.0MPa
Negative pressure performance: -99.975kPa

Handling instructions

- ⚠ **Caution** When the working conditions of tubes and fittings differ, use them under the lower specified conditions.
- ⚠ **Caution** When water is used as the operating fluid, confirm that there is no water leakage damage to equipment and instruments due to construction failure.
- ⚠ **Caution** When water is used as the operating fluid, do not allow it to freeze.
- ⚠ **Caution** Do not bend the pipe sharply near the tube insertion port of the fitting. Keep the tube straight for twice as long as the tube diameter from the insertion port.

See page 34 for the common handling instructions for tube fittings.

Product number example

AL 6 - R1/8

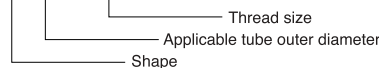

Applicable tube

Polyurethane tube	Nylon tube	Flame-resistant tube	Antistatic tube	Polyolefine resin tube	Fluorocarbon resin tube
U2***P.12 U1***P.13 U5***P.14	N2***P.15 N5***P.16 N1***P.17	FS*****P.20 FW*****P.21 FWU***P.22	UE***P.23	PL***P.26 PN***P.27	TA***P.28 TP***P.29

(*1) When the PushOne A series is used with a UE tube, choose a metal body type including a connector and a hexagonal socket to maintain conductivity between the tube and the fittings.
(*2) Combinatory use of PL, PN, TA or TP tube and PushOne A series mixes general and clean type performances. When using them in a clean environment, pay attention to the clean level that could be lowered.

Allied products and product introduction

P.144	P.151	P.156	P.159	P.160	P.169
-------	-------	-------	-------	-------	-------

Reference

Instruction manual	P.178
UL-94 standard flame test	P.204
Effective cross-sectional area	P.176
Negative-pressure performance list	P.177

Tube
Clean tube
Processed tube
PushOne fitting
QuickSeal fitting
Clean fitting/Chemifit
Bamboo-shoot fitting
Control switch/Detachable series
Jig/Tool/Accessory
Technical information
Reference

PushOne® A Series

Shape list



Tube

Clean tube

Processed tube

PushOne fitting

QuickSeal fitting

Clean fitting/Chemifit

Bamboo-shoot fitting

Control switch/Detachable series

Jig/Tool/Accessory

Technical information

Reference

Connector

●Millimeter size type

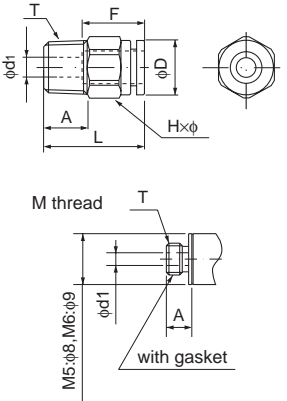

Product number	Applicable tube outer diameter (mm)	T Thread size (M,R)	L (mm)	A (mm)	F Tube insertion length (mm)	H×φ Width across flat (mm)	D (mm)	d1 (mm)	Effective cross-sectional area (mm ²)	Weight (g)
AC4-M5	4	M5×0.8	22.4	4.0	13	10.0×11.0	9.6	2.0	3.0	6.0
AC4-R1/8	4	R1/8	19.4	8.0	13	10.0×11.0	9.6	2.5	4.0	7.0
AC4-R1/4	4	R1/4	22.4	11.0	13	14.0×15.4	9.6	2.5	4.0	17.0
AC6-M5	6	M5×0.8	24.2	4.0	15	12.0×13.0	11.7	2.0	3.5	9.0
AC6-M6	6	M6×1.0	25.2	5.0	15	12.0×13.0	11.7	3.0	4.5	10.0
AC6-R1/8	6	R1/8	21.2	8.0	15	12.0×13.0	11.7	4.0	10.5	9.0
AC6-R1/4	6	R1/4	24.2	11.0	15	14.0×15.4	11.7	4.0	10.5	18.0
AC6-R3/8	6	R3/8	25.2	12.0	15	17.0×18.5	11.7	4.0	10.5	32.0
AC8-R1/8	8	R1/8	26.2	8.0	16	14.0×15.4	13.7	5.0	20.0	14.0
AC8-R1/4	8	R1/4	25.2	11.0	16	14.0×15.4	13.7	6.0	25.0	16.0
AC8-R3/8	8	R3/8	26.2	12.0	16	17.0×18.5	13.7	6.0	26.0	29.0
AC10-R1/8	10	R1/8	30.1	8.0	19	17.0×18.5	16.7	5.0	25.0	24.0
AC10-R1/4	10	R1/4	28.1	11.0	19	17.0×18.5	16.7	8.0	40.0	21.0
AC10-R3/8	10	R3/8	29.1	12.0	19	17.0×18.5	16.7	8.0	40.0	29.0
AC10-R1/2	10	R1/2	32.1	15.0	19	22.0×24.5	16.7	8.0	40.0	61.0
AC12-R1/4	12	R1/4	34.0	11.0	20	19.0×21.0	18.6	8.0	45.0	32.0
AC12-R3/8	12	R3/8	30.0	12.0	20	19.0×21.0	18.6	10.0	50.0	31.0
AC12-R1/2	12	R1/2	33.0	15.0	20	22.0×24.5	18.6	10.0	50.0	58.0
AC16-R3/8	16	R3/8	41.6	12.0	27	24.0×26.5	24.5	10.0	77.0	68.0
AC16-R1/2	16	R1/2	43.6	15.0	27	24.0×26.5	24.5	12.0	110.5	83.0

*Made to order

Hexagon socket connector

●Millimeter size type

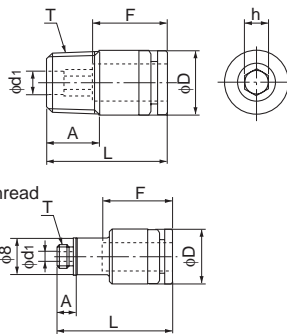

Product number	Applicable tube outer diameter (mm)	T Thread size (M,R)	L (mm)	A (mm)	F Tube insertion length (mm)	h Width across flat (mm)	D (mm)	d1 (mm)	Effective cross-sectional area (mm ²)	Weight (g)
AC4-M5A	4	M5×0.8	19.4	4.0	13	2.0	9.8	2.0	—	5.0
AC4-R1/8A	4	R1/8	19.4	8.0	13	2.5	9.8	2.5	—	7.0
AC6-M5A	6	M5×0.8	24.2	4.0	15	4.0	11.8	2.0	—	—
AC6-R1/8A	6	R1/8	21.2	8.0	15	4.0	11.8	4.0	—	8.0
AC6-R1/4A	6	R1/4	24.2	11.0	15	4.0	13.8	4.0	—	17.0
AC8-R1/8A	8	R1/8	26.2	8.0	16	5.0	13.8	5.0	—	12.0
AC8-R1/4A	8	R1/4	25.2	11.0	16	5.0	13.8	5.0	—	15.0
AC10-R1/4A	10	R1/4	28.1	11.0	19	6.0	16.8	6.0	—	19.0
AC10-R3/8A	10	R3/8	29.1	12.0	19	6.0	16.8	6.0	—	28.0

Internal connector

●Millimeter size type

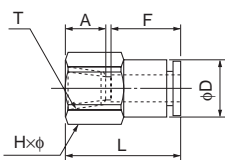

Product number	Applicable tube outer diameter (mm)	T Thread size (Rc)	L (mm)	A (mm)	F Tube insertion length (mm)	H×φ Width across flat (mm)	D (mm)	Min. inner diameter (mm)	Effective cross-sectional area (mm ²)	Weight (g)
AFC4-R1/8	4	Rc1/8	23.9	8.7	13	14.0×15.4	10.0	3.0	4.0	16.0
AFC6-R1/8	6	Rc1/8	24.8	8.7	15	14.0×15.4	12.0	5.0	10.5	17.0
AFC6-R1/4	6	Rc1/4	29.3	13.0	15	17.0×18.5	12.0	5.0	10.5	26.0
AFC8-R1/4	8	Rc1/4	30.9	13.0	16	17.0×18.5	13.9	7.0	25.0	28.0
AFC8-R3/8	8	Rc3/8	31.4	13.5	16	22.0×24.5	13.9	7.0	26.0	45.0
AFC10-R1/4	10	Rc1/4	33.9	13.0	19	17.0×18.5	16.9	9.0	40.0	34.0
AFC10-R3/8	10	Rc3/8	34.4	13.5	19	22.0×24.5	16.9	9.0	40.0	50.0
AFC10-R1/2	10	Rc1/2	38.4	17.5	19	24.0×26.5	16.9	9.0	40.0	56.0
AFC12-R1/4	12	Rc1/4	34.5	13.0	20	19.0×21.0	19.0	10.0	45.0	43.0
AFC12-R3/8	12	Rc3/8	35.3	13.5	20	22.0×24.5	19.0	11.0	50.0	50.0
AFC12-R1/2	12	Rc1/2	39.3	17.5	20	24.0×26.5	19.0	11.0	50.0	58.0

Tube

Clean tube

Processed tube

PushOne fitting

QuickSeal fitting

Clean fitting/ Chemifit

Bamboo-shoot fitting

Control switch/ Detachable series

Jig/Tool/ Accessory

Technical information

Reference

90 degree elbow

●Millimeter size type

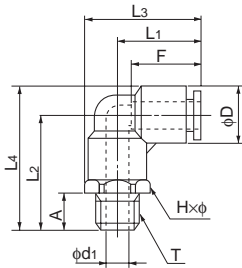

M thread

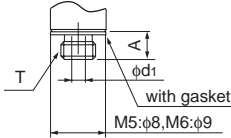

Product number	Applicable tube outer diameter (mm)	T Thread size (M,R)	L ₁ (mm)	L ₂ (mm)	L ₃ (mm)	L ₄ (mm)	A (mm)	F Tube insertion length (mm)	H×φ Width across flat (mm)	D (mm)	d ₁ (mm)	Min. inner diameter (mm)	Effective cross-sectional area (mm ²)	Weight (g)
AL4-M5	4	M5×0.8	17.2	20.2	22.7	25.1	4.0	13	10.0×11.0	9.8	2.0	2.0	3.0	7.0
AL4-R1/8	4	R1/8	17.2	22.7	22.7	27.6	8.0	13	10.0×11.0	9.8	5.0	3.0	4.0	9.0
AL4-R1/4	4	R1/4	17.2	26.7	24.9	31.6	11.0	13	14.0×15.4	9.8	7.0	3.0	4.0	16.0
AL6-M5	6	M5×0.8	18.5	22.7	25.0	29.0	4.0	15	12.0×13.0	12.6	2.0	2.0	3.5	10.0
AL6-M6	6	M6×1.0	18.5	22.7	25.0	29.0	5.0	15	12.0×13.0	12.6	3.0	3.0	4.5	11.0
AL6-R1/8	6	R1/8	18.5	25.2	25.0	31.5	8.0	15	12.0×13.0	12.6	5.0	5.0	12.0	18.0
AL6-R1/4	6	R1/4	18.5	29.2	26.2	35.5	11.0	15	14.0×15.4	12.6	7.0	5.0	12.0	18.0
AL6-R3/8	6	R3/8	18.5	30.2	27.8	36.5	12.0	15	17.0×18.5	12.6	9.0	5.0	12.0	26.0
AL8-R1/8	8	R1/8	20.7	26.2	28.4	33.5	8.0	16	14.0×15.4	14.5	5.0	5.0	18.5	15.0
AL8-R1/4	8	R1/4	20.7	30.2	28.4	37.5	11.0	16	14.0×15.4	14.5	7.0	7.0	23.0	20.0
AL8-R3/8	8	R3/8	20.7	31.2	30.0	38.5	12.0	16	17.0×18.5	14.5	9.0	7.0	23.0	28.0
AL10-R1/8	10	R1/8	24.7	29.2	33.9	38.0	8.0	19	17.0×18.5	17.5	5.0	5.0	22.0	22.0
AL10-R1/4	10	R1/4	24.7	33.2	33.9	42.0	11.0	19	17.0×18.5	17.5	7.0	7.0	34.5	27.0
AL10-R3/8	10	R3/8	24.7	34.2	33.9	43.0	12.0	19	17.0×18.5	17.5	9.0	9.0	37.0	33.0
AL10-R1/2	10	R1/2	24.7	38.2	36.9	47.0	15.0	19	22.0×24.5	17.5	12.0	9.0	37.0	52.0
AL12-R1/4	12	R1/4	26.3	35.7	36.8	45.7	11.0	20	19.0×21.0	20.0	7.0	7.0	36.0	34.0
AL12-R3/8	12	R3/8	26.3	36.7	36.8	46.7	12.0	20	19.0×21.0	20.0	9.0	9.0	43.0	39.0
AL12-R1/2	12	R1/2	26.3	40.7	38.6	50.7	15.0	20	22.0×24.5	20.0	12.0	10.0	43.0	56.0
AL16-R3/8	16	R3/8	34.9	45.0	48.4	58.8	12.0	27	24.0×27.0	28.0	11.0	11.0	70.0	70.0
AL16-R1/2	16	R1/2	34.9	48.0	48.4	61.8	15.0	27	24.0×27.0	28.0	12.0	12.0	93.0	84.0

*Made to order

90 degree internal elbow

●Millimeter size type

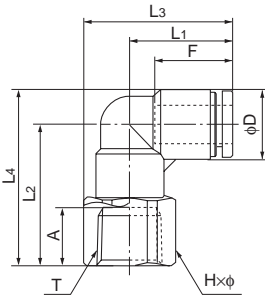

Product number	Applicable tube outer diameter (mm)	T Thread size (Rc)	L ₁ (mm)	L ₂ (mm)	L ₃ (mm)	L ₄ (mm)	A (mm)	F Tube insertion length (mm)	H×φ Width across flat (mm)	D (mm)	Min. inner diameter (mm)	Effective cross-sectional area (mm ²)	Weight (g)
AFL4-R1/8	4	Rc1/8	17.2	21.7	24.9	22.1	8.0	13	14.0×15.4	9.8	3.0	—	—
AFL6-R1/8	6	Rc1/8	18.5	24.2	26.2	30.5	8.0	15	14.0×15.4	12.6	5.0	—	15.0
AFL6-R1/4	6	Rc1/4	18.5	28.2	27.8	34.5	12.0	15	17.0×18.5	12.6	5.0	—	23.0
AFL6-R3/8	6	Rc3/8	18.5	28.7	30.8	35.0	12.5	15	22.0×24.5	12.6	5.0	—	37.0
AFL8-R1/8	8	Rc1/8	20.7	25.2	28.4	32.5	8.0	16	14.0×15.4	14.6	7.0	—	17.0
AFL8-R1/4	8	Rc1/4	20.7	29.2	30.0	36.5	12.0	16	17.0×18.5	14.6	7.0	—	25.0
AFL8-R3/8	8	Rc3/8	20.7	29.7	33.0	37.0	12.5	16	22.0×24.5	14.6	7.0	—	38.0
AFL10-R1/4	10	Rc1/4	24.7	32.2	34.0	41.0	12.0	19	17.0×18.5	17.5	9.0	—	29.0
AFL10-R3/8	10	Rc3/8	24.7	33.7	37.0	42.5	12.5	19	22.0×24.5	17.5	9.0	—	45.0
AFL12-R3/8	12	Rc3/8	26.3	36.2	38.6	46.2	12.5	20	22.0×24.5	20.0	10.0	—	49.0
AFL12-R1/2	12	Rc1/2	26.3	39.2	39.6	49.2	15.5	20	24.0×26.5	20.0	10.0	—	54.0

Tube

Clean tube

Processed tube

PushOne fitting

QuickSeal fitting

Clean fitting/ Chemifit

Bamboo-shoot fitting

Control switch/ Detachable series

Jig/Tool/ Accessory

Technical information

Reference

90 degree long elbow

●Millimeter size type

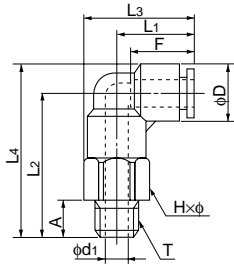

M thread

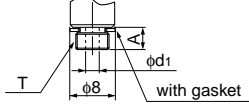

Product number	Applicable tube outer diameter (mm)	T Thread size (M,R)	L ₁ (mm)	L ₂ (mm)	L ₃ (mm)	L ₄ (mm)	A (mm)	F Tube insertion length (mm)	H×φ Width across flat (mm)	D (mm)	d ₁ (mm)	Min. inner diameter (mm)	Effective cross-sectional area (mm ²)	Weight (g)
ALL4-M5	4	M5×0.8	17.2	29.9	22.7	34.8	4.0	13	10.0×11.0	9.8	2.0	2.0	3.0	13.0
ALL4-R1/8	4	R1/8	17.2	32.4	22.7	37.3	8.0	13	10.0×11.0	9.8	5.0	3.0	4.0	14.0
ALL4-R1/4	4	R1/4	17.2	36.4	24.9	41.3	11.0	13	14.0×15.4	9.8	7.0	3.0	4.0	27.0
ALL6-M5	6	M5×0.8	18.5	34.7	25.0	41.0	4.0	15	12.0×13.0	12.6	2.0	2.0	3.5	20.0
ALL6-R1/8	6	R1/8	18.5	37.2	25.0	43.5	8.0	15	12.0×13.0	12.6	5.0	5.0	12.0	22.0
ALL6-R1/4	6	R1/4	18.5	41.2	26.2	47.5	11.0	15	14.0×15.4	12.6	7.0	5.0	12.0	31.0
ALL6-R3/8	6	R3/8	18.5	42.2	27.8	48.5	12.0	15	17.0×18.5	12.6	9.0	5.0	12.0	45.0
ALL8-R1/8	8	R1/8	20.7	40.2	28.4	47.5	8.0	16	14.0×15.4	14.6	5.0	5.0	18.5	30.0
ALL8-R1/4	8	R1/4	20.7	44.2	28.4	51.5	11.0	16	14.0×15.4	14.6	7.0	7.0	23.0	35.0
ALL8-R3/8	8	R3/8	20.7	45.2	30.0	52.5	12.0	16	17.0×18.5	14.6	9.0	7.0	23.0	50.0
ALL10-R1/8	10	R1/8	24.7	46.2	33.9	55.0	8.0	19	17.0×18.5	17.5	5.0	5.0	22.0	48.0
ALL10-R1/4	10	R1/4	24.7	50.2	33.9	59.0	11.0	19	17.0×18.5	17.5	7.0	7.0	34.5	53.0
ALL10-R3/8	10	R3/8	24.7	51.2	33.9	60.0	12.0	19	17.0×18.5	17.5	9.0	9.0	37.0	59.0
ALL10-R1/2	10	R1/2	24.7	55.2	36.9	64.0	15.0	19	22.0×24.5	17.5	12.0	9.0	37.0	94.0
ALL12-R1/4	12	R1/4	26.3	55.2	36.8	65.2	11.0	20	19.0×21.0	20.0	7.0	7.0	36.0	72.0
ALL12-R3/8	12	R3/8	26.3	56.2	36.8	66.2	12.0	20	19.0×21.0	20.0	9.0	9.0	43.0	78.0
ALL12-R1/2	12	R1/2	26.3	60.2	38.6	70.2	15.0	20	22.0×24.5	20.0	12.0	10.0	43.0	105.0

45 degree elbow

●Millimeter size type

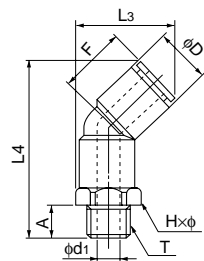

M thread

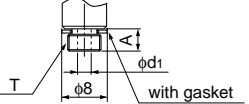

Product number	Applicable tube outer diameter (mm)	T Thread size (M,R)	L ₃ (mm)	L ₄ (mm)	A (mm)	F Tube insertion length (mm)	H×φ Width across flat (mm)	D (mm)	d ₁ (mm)	Min. inner diameter (mm)	Effective cross-sectional area (mm ²)	Weight (g)
A45L4-M5	4	M5×0.8	19.7	34.4	4.0	13	10.0×11.0	9.8	2.0	2.0	3.0	7.0
A45L4-R1/8	4	R1/8	19.7	36.9	8.0	13	10.0×11.0	9.8	5.0	3.0	4.0	9.0
A45L4-R1/4	4	R1/4	21.9	40.9	11.0	13	14.0×15.4	9.8	7.0	3.0	4.0	16.0
A45L6-M5	6	M5×0.8	22.4	38.6	4.0	15	12.0×13.0	12.6	2.0	2.0	3.5	10.0
A45L6-R1/8	6	R1/8	22.4	41.1	8.0	15	12.0×13.0	12.6	5.0	5.0	12.0	12.0
A45L6-R1/4	6	R1/4	23.6	45.1	11.0	15	14.0×15.4	12.6	7.0	5.0	12.0	18.0
A45L6-R3/8	6	R3/8	25.2	46.1	12.0	15	17.0×18.5	12.6	9.0	5.0	12.0	26.0
A45L8-R1/8	8	R1/8	25.5	44.0	8.0	16	14.0×15.4	14.6	5.0	5.0	18.5	15.0
A45L8-R1/4	8	R1/4	25.5	48.0	11.0	16	14.0×15.4	14.6	7.0	7.0	23.0	20.0
A45L8-R3/8	8	R3/8	27.0	49.0	12.0	16	17.0×18.5	14.6	9.0	7.0	23.0	28.0
A45L10-R1/8	10	R1/8	30.0	50.0	8.0	19	17.0×18.5	17.5	5.0	5.0	22.0	22.0
A45L10-R1/4	10	R1/4	30.0	54.0	11.0	19	17.0×18.5	17.5	7.0	7.0	34.5	27.0
A45L10-R3/8	10	R3/8	30.0	55.0	12.0	19	17.0×18.5	17.5	9.0	9.0	37.0	33.0
A45L10-R1/2	10	R1/2	33.0	59.0	15.0	19	22.0×24.5	17.5	12.0	9.0	38.5	52.0
A45L12-R1/4	12	R1/4	33.5	58.7	11.0	20	19.0×21.0	20.0	7.0	7.0	43.0	34.0
A45L12-R3/8	12	R3/8	33.5	59.7	12.0	20	19.0×21.0	20.0	9.0	9.0	47.0	40.0
A45L12-R1/2	12	R1/2	35.3	63.7	15.0	20	22.0×24.5	20.0	12.0	10.0	47.0	57.0

Tube

Clean tube

Processed tube

PushOne fitting

QuickSeal fitting

Clean fitting/ Chemifit

Bamboo-shoot fitting

Control switch/ Detachable series

Jig/Tool/ Accessory

Technical information

Reference

Universal elbow

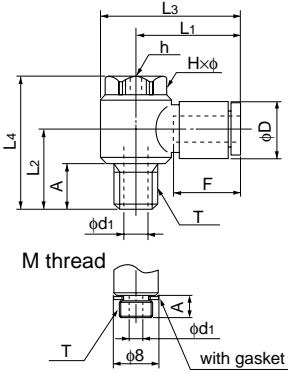

●Millimeter size type

Product number	Applicable tube outer diameter (mm)	T Thread size (M,R)	L ₁ (mm)	L ₂ (mm)	L ₃ (mm)	L ₄ (mm)	A (mm)	F Tube insertion length (mm)	H×φ Width across flat (mm)	h (mm)	D (mm)	d ₁ (mm)	Min. inner diameter (mm)	Effective cross-sectional area (mm ²)	Weight (g)
ALB4-M5	4	M5×0.8	20.4	11.5	25.3	21.0	4.0	13	8.0×9.0	3.0	9.8	2.0	2.0	3.0	10.0
ALB4-R1/8	4	R1/8	23.4	17.5	30.4	30.0	9.5	13	13.0×14.0	5.0	9.8	5.0	3.0	4.0	20.0
ALB6-M5	6	M5×0.8	20.8	11.5	25.6	21.0	4.0	15	8.0×9.0	3.0	12.6	2.0	2.0	3.5	10.0
ALB6-R1/8	6	R1/8	22.8	17.5	29.8	30.0	9.5	15	13.0×14.0	5.0	12.6	5.0	3.2	8.0	21.0
ALB6-R1/4	6	R1/4	24.8	22.9	34.5	37.5	13.4	15	17.0×18.3	6.0	12.6	7.0	4.2	9.0	43.0
ALB8-R1/8	8	R1/8	24.4	17.5	31.4	30.0	9.5	16	13.0×14.0	5.0	14.6	5.0	3.2	9.0	41.0
ALB8-R1/4	8	R1/4	26.4	22.9	36.1	37.5	13.4	16	17.0×18.3	6.0	14.6	7.0	4.2	14.5	44.0
ALB8-R3/8	8	R3/8	28.4	24.4	40.4	40.5	13.9	16	21.0×22.6	8.0	14.6	9.0	6.0	19.0	69.0
ALB10-R1/4	10	R1/4	29.4	22.9	39.1	37.5	13.4	19	17.0×18.3	6.0	17.5	7.0	4.2	15.5	74.0
ALB10-R3/8	10	R3/8	31.4	24.4	43.4	40.5	13.9	19	21.0×22.6	8.0	17.5	9.0	6.0	23.0	74.0
ALB12-R3/8	12	R3/8	34.3	24.3	48.3	40.5	13.8	20	24.0×26.0	8.0	20.0	10.0	8.0	25.5	92.0
ALB12-R1/2	12	R1/2	34.3	27.3	48.3	43.5	16.8	20	24.0×26.0	8.0	20.0	12.0	8.0	25.5	100.0

90 degree branch elbow

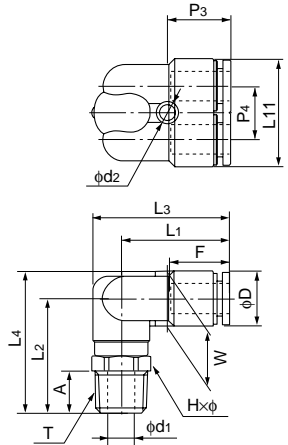

●Millimeter size type

Product number	Applicable tube outer diameter (mm)	T Thread size (R)	L ₁ (mm)	L ₂ (mm)	L ₃ (mm)	L ₄ (mm)	L ₁₁ (mm)	A (mm)	F Tube insertion length (mm)	H×φ Width across flat (mm)	P ₃ (mm)	P ₄ (mm)	W (mm)	D (mm)	d ₁ (mm)	d ₂ (mm)	Effective cross-sectional area (mm ²)	Weight (g)
ALY6-R1/8	6	R1/8	25.6	25.2	32.1	31.5	24.8	8.0	15	12.0×13.0	14.8	12.2	12.6	12.6	5.0	4.2	—	16.0
ALY6-R1/4	6	R1/4	25.6	29.2	33.3	35.5	24.8	11.0	15	14.0×15.4	14.8	12.2	12.6	12.6	7.0	4.2	—	23.0
ALY8-R1/8	8	R1/8	28.2	26.2	35.9	33.5	28.8	8.0	16	14.0×15.4	16.4	14.2	14.6	14.6	5.0	4.2	—	21.0
ALY8-R1/4	8	R1/4	28.2	30.2	35.9	37.5	28.8	11.0	16	14.0×15.4	16.4	14.2	14.6	14.6	7.0	4.2	—	27.0
ALY8-R3/8	8	R3/8	28.2	31.2	37.5	38.5	28.8	12.0	16	17.0×18.5	16.4	14.2	14.6	14.6	9.0	4.2	—	35.0
ALY10-R1/4	10	R1/4	31.3	33.2	40.5	42.0	35.0	11.0	19	17.0×18.5	18.4	17.5	17.5	17.5	7.0	4.2	—	37.0
ALY10-R3/8	10	R3/8	31.3	34.2	40.5	43.0	35.0	12.0	19	17.0×18.5	18.4	17.5	17.5	17.5	9.0	4.2	—	43.0

Tube

Clean tube

Processed tube

PushOne fitting

QuickSeal fitting

Clean fitting/ Chemifit

Bamboo-shoot fitting

Control switch/ Detachable series

Jig/Tool/ Accessory

Technical information

Reference

Universal branch elbow

●Millimeter size type



Product number	Applicable tube outer diameter (mm)	T Thread size (R)	L ₁ (mm)	L ₂ (mm)	L ₃ (mm)	L ₄ (mm)	L ₁₁ (mm)	A (mm)	F Tube insertion length (mm)	H×Φ Width across flat (mm)	h Width across flat (mm)	P ₃ (mm)	P ₄ (mm)	W (mm)	D (mm)	d ₁ (mm)	d ₂ (mm)	Effective cross-sectional area (mm ²)	Weight (g)
ALYB6-R1/8	6	R1/8	26.1	17.5	33.1	30.0	24.8	8.0	15	13.0×14.0	5.0	14.8	12.2	12.6	12.6	5.0	4.2	—	25.0
ALYB6-R1/4	6	R1/4	29.0	22.9	38.7	37.5	24.8	11.0	15	17.0×18.3	6.0	14.8	12.2	12.6	12.6	7.0	4.2	—	46.0
ALYB8-R1/4	8	R1/4	30.6	22.9	40.3	37.5	28.8	11.0	16	17.0×18.3	6.0	16.4	14.2	14.6	14.6	7.0	4.2	—	49.0
ALYB8-R3/8	8	R3/8	32.9	22.5	40.5	40.5	28.8	12.0	16	21.0×22.6	8.0	16.4	14.2	14.6	14.6	9.0	4.2	—	58.0
ALYB10-R1/4	10	R1/4	34.9	23.4	46.9	39.5	35.0	11.0	19	21.0×22.6	8.0	18.4	17.5	17.5	17.5	7.0	4.2	—	78.0
ALYB10-R3/8	10	R3/8	34.9	24.4	46.9	40.5	35.0	12.0	19	21.0×22.6	8.0	18.4	17.5	17.5	17.5	9.0	4.2	—	80.0

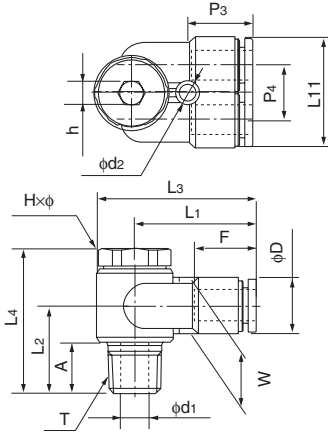

Double universal elbow

●Millimeter size type



Product number	Applicable tube outer diameter (mm)	T Thread size (R)	L ₁ (mm)	L ₂ (mm)	L ₃ (mm)	L ₄ (mm)	L ₅ (mm)	A (mm)	F Tube insertion length (mm)	H×Φ Width across flat (mm)	D (mm)	d ₁ (mm)	Effective cross-sectional area (mm ²)	Weight (g)
ALWB6-R1/8	6	R1/8	22.8	18.8	30.5	42.3	13.5	8.0	15	14.0×15.4	12.6	5.0	—	33.0
ALWB6-R1/4	6	R1/4	22.8	21.8	30.5	45.3	13.5	11.0	15	14.0×15.4	12.6	7.0	—	35.0
ALWB8-R1/4	8	R1/4	24.4	23.0	32.1	50.0	16.0	11.0	16	14.0×15.4	14.6	7.0	—	39.0
ALWB8-R3/8	8	R3/8	24.4	24.0	32.1	54.0	16.0	12.0	16	17.0×18.5	14.6	9.0	—	47.0
ALWB10-R1/4	10	R1/4	29.4	24.5	39.1	56.0	19.0	11.0	19	17.0×18.5	17.5	7.0	—	72.0
ALWB10-R3/8	10	R3/8	29.4	25.5	39.1	57.0	19.0	12.0	19	17.0×18.5	17.5	9.0	—	70.0

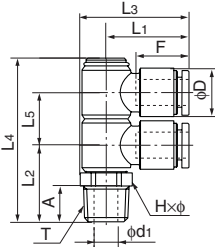

Triple universal elbow

●Millimeter size type



Product number	Applicable tube outer diameter (mm)	T Thread size (R)	L ₁ (mm)	L ₂ (mm)	L ₃ (mm)	L ₄ (mm)	L ₅ (mm)	A (mm)	F Tube insertion length (mm)	H×Φ Width across flat (mm)	D (mm)	d ₁ (mm)	Effective cross-sectional area (mm ²)	Weight (g)
ALTB6-R1/8	6	R1/8	22.8	18.8	30.5	55.5	13.5	8.0	15	14.0×15.4	12.6	5.0	—	43.0
ALTB6-R1/4	6	R1/4	22.8	21.8	30.5	58.5	13.5	11.0	15	14.0×15.4	12.6	7.0	—	45.0
ALTB8-R1/4	8	R1/4	24.4	23.0	32.1	66.0	16.0	11.0	16	14.0×15.4	14.6	7.0	—	51.0
ALTB8-R3/8	8	R3/8	24.4	24.0	32.1	67.0	16.0	12.0	16	17.0×18.5	14.6	9.0	—	59.0
ALTB10-R1/4	10	R1/4	29.4	24.5	39.1	75.5	19.0	11.0	19	17.0×18.5	17.5	7.0	—	98.0
ALTB10-R3/8	10	R3/8	29.4	25.5	39.1	76.5	19.0	12.0	19	17.0×18.5	17.5	9.0	—	92.0

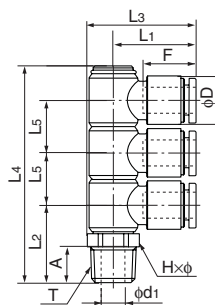

Tube

Clean tube

Processed tube

PushOne fitting

QuickSeal fitting

Clean fitting/ Chemifit

Bamboo-shoot fitting

Control switch/ Detachable series

Jig/Tool/ Accessory

Technical information

Reference

Tee

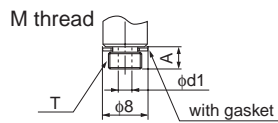
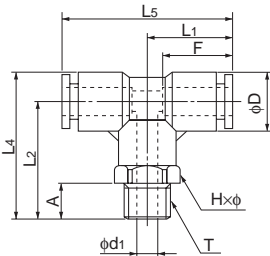

●Millimeter size type

Product number	Applicable tube outer diameter (mm)	T Thread size (M,R)	L ₁ (mm)	L ₂ (mm)	L ₄ (mm)	L ₅ (mm)	A (mm)	F Tube insertion length (mm)	H×φ Width across flat (mm)	D (mm)	d ₁ (mm)	Min. inner diameter (mm)	Effective cross-sectional area (mm ²)	Weight (g)
AT4-M5	4	M5×0.8	17.2	20.2	25.1	34.4	4.0	13	10.0×11.0	9.8	2.0	2.0	3.0	8.0
AT4-R1/8	4	R1/8	17.2	22.7	27.6	34.4	8.0	13	10.0×11.0	9.8	5.0	3.0	4.0	10.0
AT4-R1/4	4	R1/4	17.2	26.7	31.6	34.4	11.0	13	14.0×15.4	9.8	7.0	3.0	4.0	17.0
AT6-M5	6	M5×0.8	18.5	22.7	29.0	37.0	4.0	15	12.0×13.0	12.6	2.0	2.0	3.5	12.0
AT6-R1/8	6	R1/8	18.5	25.2	31.5	37.0	8.0	15	12.0×13.0	12.6	5.0	5.0	12.0	14.0
AT6-R1/4	6	R1/4	18.5	29.2	35.5	37.0	11.0	15	14.0×15.4	12.6	7.0	5.0	12.0	21.0
AT6-R3/8	6	R3/8	18.5	30.2	36.5	37.0	12.0	15	17.0×18.5	12.6	9.0	5.0	12.0	29.0
AT8-R1/8	8	R1/8	20.7	26.2	33.5	41.4	8.0	16	14.0×15.4	14.6	5.0	5.0	18.5	18.0
AT8-R1/4	8	R1/4	20.7	30.2	37.5	41.4	11.0	16	14.0×15.4	14.6	7.0	7.0	23.0	24.0
AT8-R3/8	8	R3/8	20.7	31.2	38.5	41.4	12.0	16	17.0×18.5	14.6	9.0	7.0	23.0	32.0
AT10-R1/8	10	R1/8	24.7	29.2	38.0	49.3	8.0	19	17.0×18.5	17.5	5.0	5.0	22.0	28.0
AT10-R1/4	10	R1/4	24.7	33.2	42.0	49.3	11.0	19	17.0×18.5	17.5	7.0	7.0	34.5	34.0
AT10-R3/8	10	R3/8	24.7	34.2	43.0	49.3	12.0	19	17.0×18.5	17.5	9.0	9.0	37.0	39.0
AT10-R1/2	10	R1/2	24.7	38.2	47.0	49.3	15.0	19	22.0×24.5	17.5	12.0	9.0	37.0	58.0
AT12-R1/4	12	R1/4	26.3	35.7	45.7	52.6	11.0	20	19.0×21.0	20.0	7.0	7.0	36.0	43.0
AT12-R3/8	12	R3/8	26.3	36.7	46.7	52.6	12.0	20	19.0×21.0	20.0	9.0	9.0	43.0	48.0
AT12-R1/2	12	R1/2	26.3	40.7	50.7	52.6	15.0	20	22.0×24.5	20.0	12.0	10.0	43.0	65.0
AT16-R3/8	16	R3/8	34.9	45.0	58.8	69.8	12.0	27	24.0×27.0	28.0	11.0	11.0	70.0	92.0
AT16-R1/2	16	R1/2	34.9	48.0	61.8	69.8	15.0	27	24.0×27.0	28.0	12.0	12.0	93.0	106.0

Service tee

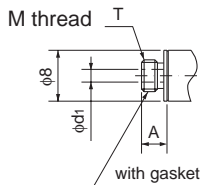
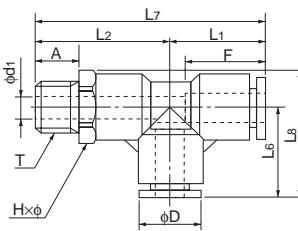

●Millimeter size type

Product number	Applicable tube outer diameter (mm)	T Thread size (M,R)	L ₁ (mm)	L ₂ (mm)	L ₆ (mm)	L ₇ (mm)	L ₈ (mm)	A (mm)	F Tube insertion length (mm)	H×φ Width across flat (mm)	D (mm)	d ₁ (mm)	Min. inner diameter (mm)	Effective cross-sectional area (mm ²)	Weight (g)
AST4-M5	4	M5×0.8	17.2	20.2	17.2	37.4	22.1	4.0	13	10.0×11.0	9.8	2.0	2.0	3.0	8.0
AST4-R1/8	4	R1/8	17.2	22.7	17.2	39.9	22.1	8.0	13	10.0×11.0	9.8	5.0	3.0	4.0	10.0
AST4-R1/4	4	R1/4	17.2	26.7	17.2	43.9	24.9	11.0	13	14.0×15.4	9.8	7.0	3.0	4.0	18.0
AST6-M5	6	M5×0.8	18.5	22.7	18.5	41.2	25.0	4.0	15	12.0×13.0	12.6	2.0	2.0	3.5	12.0
AST6-R1/8	6	R1/8	18.5	25.2	18.5	43.7	25.0	8.0	15	12.0×13.0	12.6	5.0	5.0	12.0	14.0
AST6-R1/4	6	R1/4	18.5	29.2	18.5	47.7	26.2	11.0	15	14.0×15.4	12.6	7.0	5.0	12.0	21.0
AST6-R3/8	6	R3/8	18.5	30.2	18.5	48.7	27.8	12.0	15	17.0×18.5	12.6	9.0	5.0	12.0	29.0
AST8-R1/8	8	R1/8	20.7	26.2	20.7	46.9	28.4	8.0	16	14.0×15.4	14.6	5.0	5.0	18.5	18.0
AST8-R1/4	8	R1/4	20.7	30.2	20.7	50.9	28.4	11.0	16	14.0×15.4	14.6	7.0	7.0	23.0	24.0
AST8-R3/8	8	R3/8	20.7	31.2	20.7	51.9	30.0	12.0	16	17.0×18.5	14.6	9.0	7.0	23.0	32.0
AST10-R1/8	10	R1/8	24.7	29.2	24.7	53.9	33.9	8.0	19	17.0×18.5	17.5	5.0	5.0	22.0	28.0
AST10-R1/4	10	R1/4	24.7	33.2	24.7	57.9	33.9	11.0	19	17.0×18.5	17.5	7.0	7.0	34.5	34.0
AST10-R3/8	10	R3/8	24.7	34.2	24.7	58.9	33.9	12.0	19	17.0×18.5	17.5	9.0	9.0	37.0	40.0
AST10-R1/2	10	R1/2	24.7	38.2	24.7	62.9	36.9	15.0	19	22.0×24.5	17.5	12.0	9.0	37.0	58.0
AST12-R1/4	12	R1/4	26.3	35.7	26.3	62.0	36.8	11.0	20	19.0×21.0	20.0	7.0	7.0	36.0	43.0
AST12-R3/8	12	R3/8	26.3	36.7	26.3	63.0	36.8	12.0	20	19.0×21.0	20.0	9.0	9.0	43.0	48.0
AST12-R1/2	12	R1/2	26.3	40.7	26.3	67.0	38.6	15.0	20	22.0×24.5	20.0	12.0	10.0	43.0	65.0
AST16-R3/8	16	R3/8	34.9	45.0	34.9	79.9	48.7	12.0	27	24.0×27.0	28.0	11.0	11.0	70.0	92.0
AST16-R1/2	16	R1/2	34.9	48.0	34.9	82.9	48.7	15.0	27	24.0×27.0	28.0	12.0	12.0	93.0	106.0

Tube

Clean tube

Processed tube

PushOne fitting

QuickSeal fitting

Clean fitting/ Chemfit

Bamboo-shoot fitting

Control switch/ Detachable series

Jig/Tool/ Accessory

Technical information

Reference

Y joint

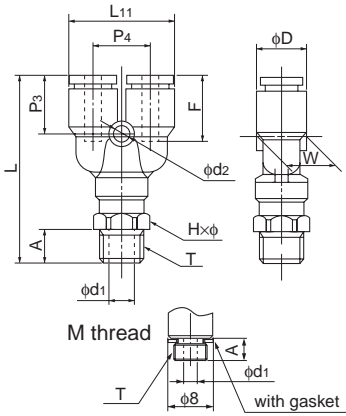

●Millimeter size type

Product number	Applicable tube outer diameter (mm)	T Thread size (M,R)	L (mm)	L ₁₁ (mm)	A (mm)	F Tube insertion length (mm)	H×φ Width across flat (mm)	P ₃ (mm)	P ₄ (mm)	W (mm)	D (mm)	d ₁ (mm)	d ₂ (mm)	Min. inner diameter (mm)	Effective cross-sectional area (mm ²)	Weight (g)
AY4-M5	4	M5×0.8	37.9	20.8	4.0	13	10.0×11.0	13.5	11.0	9.8	9.8	2.0	3.2	2.0	2.5	9.0
AY4-R1/8	4	R1/8	40.4	20.8	8.0	13	10.0×11.0	13.5	11.0	9.8	9.8	5.0	3.2	3.0	3.5	11.0
AY4-R1/4	4	R1/4	44.4	20.8	11.0	13	14.0×15.4	13.5	11.0	9.8	9.8	7.0	3.2	3.0	3.5	18.0
AY6-M5	6	M5×0.8	41.3	24.8	4.0	15	12.0×13.0	14.7	12.2	12.6	12.6	2.0	4.2	2.0	2.5	13.0
AY6-R1/8	6	R1/8	43.8	24.8	8.0	15	12.0×13.0	14.7	12.2	12.6	12.6	5.0	4.2	5.0	9.0	15.0
AY6-R1/4	6	R1/4	47.8	24.8	11.0	15	14.0×15.4	14.7	12.2	12.6	12.6	7.0	4.2	5.0	9.0	22.0
AY6-R3/8	6	R3/8	48.8	24.8	12.0	15	17.0×18.5	14.7	12.2	12.6	12.6	9.0	4.2	5.0	9.0	30.0
AY8-R1/8	8	R1/8	46.9	28.8	8.0	16	14.0×15.4	16.4	14.2	14.6	14.6	5.0	4.2	5.0	17.5	20.0
AY8-R1/4	8	R1/4	50.9	28.8	11.0	16	14.0×15.4	16.4	14.2	14.6	14.6	7.0	4.2	7.0	20.0	25.0
AY8-R3/8	8	R3/8	51.9	28.8	12.0	16	17.0×18.5	16.4	14.2	14.6	14.6	9.0	4.2	7.0	20.0	33.0
AY10-R1/4	10	R1/4	55.9	35.0	11.0	19	17.0×18.5	18.4	17.5	17.5	17.5	7.0	4.2	7.0	27.5	33.0
AY10-R3/8	10	R3/8	56.9	35.0	12.0	19	17.0×18.5	18.4	17.5	17.5	17.5	9.0	4.2	9.0	28.0	41.0
AY10-R1/2	10	R1/2	60.9	35.0	15.0	19	22.0×24.5	18.4	17.5	17.5	17.5	12.0	4.2	9.0	28.0	60.0
AY12-R1/4	12	R1/4	60.8	40.0	11.0	20	19.0×21.0	20.3	20.0	20.0	20.0	7.0	4.2	7.0	34.5	47.0
AY12-R3/8	12	R3/8	61.8	40.0	12.0	20	19.0×21.0	20.3	20.0	20.0	20.0	9.0	4.2	9.0	40.0	52.0
AY12-R1/2	12	R1/2	65.8	40.0	15.0	20	22.0×24.5	20.3	20.0	20.0	20.0	12.0	4.2	10.0	40.0	70.0
AY16-R3/8	16	R3/8	78.6	55.0	12.0	27	24.0×27.0	26.6	27.5	27.5	28.0	11.0	4.2	11.0	70.0	103.0
AY16-R1/2	16	R1/2	81.6	55.0	15.0	27	24.0×27.0	26.6	27.5	27.5	28.0	12.0	4.2	12.0	71.0	117.0

Union connector

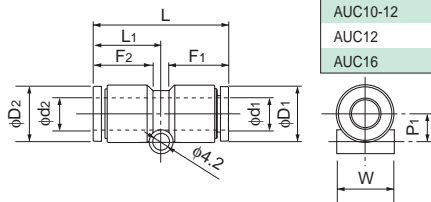

●Millimeter size type

Product number	d ₁ Applicable tube outer diameter (mm)	d ₂ Applicable tube outer diameter (mm)	L (mm)	L ₁ (mm)	P ₁ (mm)	F ₁ Tube insertion length (mm)	F ₂ Tube insertion length (mm)	D ₁ (mm)	D ₂ (mm)	W (mm)	Min. inner diameter (mm)	Effective cross-sectional area (mm ²)	Weight (g)
AUC4	4	4	31.8	15.9	5.0	13	13	9.8	9.8	9.7	4.0	3.5	4.0
AUC4-6	4	6	32.7	16.8	6.0	13	15	9.8	12.6	12.5	3.0	3.5	5.0
AUC6	6	6	33.6	16.8	6.0	15	15	12.6	12.6	12.5	6.0	12.5	6.0
AUC6-8	6	8	34.7	17.9	7.0	15	16	12.6	14.6	14.5	5.0	11.5	7.0
AUC8	8	8	35.8	17.9	7.0	16	16	14.6	14.6	14.5	8.0	28.0	8.0
AUC8-10	8	10	38.8	20.9	8.5	16	19	14.6	17.5	17.5	7.0	31.5	11.0
AUC10	10	10	41.7	20.9	8.5	19	19	17.5	17.5	17.5	14.0	45.0	14.0
AUC10-12	10	12	42.7	21.8	9.8	19	20	17.5	20.0	20.0	9.0	53.0	17.0
AUC12	12	12	43.6	21.8	9.8	20	20	20.0	20.0	20.0	19.0	67.0	19.0
AUC16	16	16	56.2	28.1	13.8	27	27	28.0	28.0	27.5	48.0	110.0	48.0

90 degree union elbow

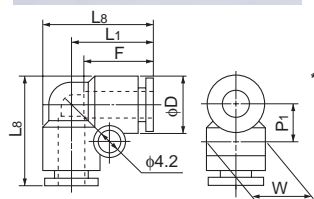

●Millimeter size type

Product number	Applicable tube outer diameter (mm)	L ₁ (mm)	L ₈ (mm)	P ₁ (mm)	F Tube insertion length (mm)	D (mm)	W (mm)	Min. inner diameter (mm)	Effective cross-sectional area (mm ²)	Weight (g)
AUL4	4	17.2	22.1	6.9	13	9.8	9.7	3.0	3.5	4.0
AUL6	6	18.5	24.8	8.3	15	12.6	12.5	5.0	9.5	6.0
AUL8	8	20.7	28.0	9.3	16	14.6	14.5	7.0	19.5	9.0
AUL10	10	24.7	33.4	10.8	19	17.5	17.5	9.0	32.5	15.0
AUL12	12	26.3	36.3	12.1	20	20.0	20.0	11.0	45.5	20.0

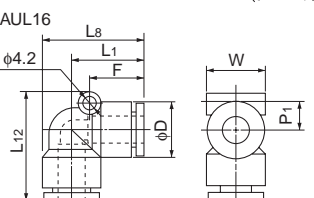

Product number	Applicable tube outer diameter (mm)	L ₁ (mm)	L ₈ (mm)	L ₁₂ (mm)	P ₁ (mm)	F Tube insertion length (mm)	D (mm)	W (mm)	Min. inner diameter (mm)	Effective cross-sectional area (mm ²)	Weight (g)
AUL16	16	34.9	48.7	50.8	12.9	27	28.0	28.0	13.0	97.5	50.0

*AUL16 has a different screw hole position.

Tube

Clean tube

Processed tube

PushOne fitting

QuickSeal fitting

Clean fitting/ Chemifit

Bamboo-shoot fitting

Control switch/ Detachable series

Jig/Tool/ Accessory

Technical information

Reference

90 degree branch elbow

●Millimeter size type



Product number	Applicable tube outer diameter (mm)	L ₁ (mm)	L ₂ (mm)	L ₃ (mm)	L ₄ (mm)	L ₁₁ (mm)	F Tube insertion length (mm)	P ₃ (mm)	P ₄ (mm)	W (mm)	D (mm)	d ₂ (mm)	Min. inner diameter (mm)	Effective cross-sectional area (mm ²)	Weight (g)
AULY6	6	25.6	18.0	31.9	24.3	24.8	15	14.8	12.2	12.6	12.6	4.2	5.0	—	10.0
AULY8	8	28.2	19.6	35.5	26.9	28.8	16	16.4	14.2	14.6	14.6	4.2	7.0	—	14.0
AULY10	10	31.3	22.6	40.0	31.3	35.0	19	18.4	17.5	17.5	17.5	4.2	9.0	—	23.0

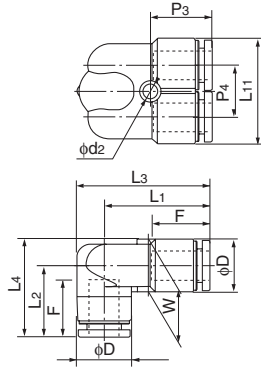

Union tee

●Millimeter size type



Product number	d ₁ Applicable tube outer diameter (mm)	d ₂ Applicable tube outer diameter (mm)	L ₁ (mm)	L ₅ (mm)	L ₆ (mm)	L ₈ (mm)	F ₁ Tube insertion length (mm)	F ₂ Tube insertion length (mm)	P ₁ (mm)	P ₂ (mm)	D ₁ (mm)	D ₂ (mm)	W (mm)	Min. inner diameter (mm)	Effective cross-sectional area (mm ²)	Weight (g)
AUT4	4	4	17.2	34.4	17.2	22.1	13	13	6.9	14.0	9.8	9.8	9.7	3.0	3.5	6.0
AUT4-6	4	6	17.7	35.4	18.0	22.9	13	15	6.8	17.0	9.8	12.6	12.5	3.0	2.5	8.0
AUT6	6	6	18.5	37.0	18.5	24.8	15	15	8.3	17.0	12.6	12.6	12.5	5.0	4.5	9.0
AUT6-8	6	8	19.5	39.0	20.4	26.7	15	16	8.2	19.0	12.6	14.6	14.5	5.0	15.5	11.0
AUT8	8	8	20.7	41.4	20.7	28.0	16	16	9.3	19.0	14.6	14.6	14.5	7.0	19.5	13.0
AUT8-10	8	10	21.7	43.4	24.4	31.7	16	19	9.2	22.0	14.6	17.5	17.5	7.0	21.0	18.0
AUT10	10	10	24.7	49.3	24.7	33.4	19	19	10.8	22.0	17.5	17.5	17.5	9.0	32.5	22.0
AUT10-12	10	12	25.6	51.1	26.3	35.1	19	20	10.8	24.0	17.5	20.0	20.0	9.0	27.0	26.0
AUT12	12	12	26.3	52.6	26.3	36.3	20	20	12.1	24.0	20.0	20.0	20.0	11.0	45.5	29.0
AUT16	16	16	34.9	69.8	34.9	48.7	27	27	15.9	31.7	28.0	28.0	27.5	13.0	97.0	73.0

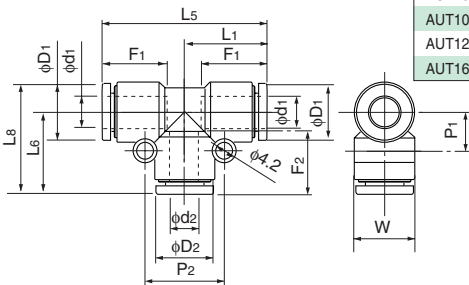

Y union

●Millimeter size type



Product number	d ₁ Applicable tube outer diameter (mm)	d ₂ Applicable tube outer diameter (mm)	L (mm)	L ₁₁ (mm)	F ₁ Tube insertion length (mm)	F ₂ Tube insertion length (mm)	P ₃ (mm)	P ₄ (mm)	W (mm)	D ₁ (mm)	D ₂ (mm)	d ₃ (mm)	Min. inner diameter (mm)	Effective cross-sectional area (mm ²)	Weight (g)
AYB4-4	4	4	33.8	20.8	13	13	13.5	11.0	9.8	9.8	9.8	3.2	3.0	3.0	6.0
AYB4-6	4	6	34.2	20.8	13	15	13.5	11.0	12.5	9.8	12.6	3.2	3.0	2.5	8.0
AYB6-6	6	6	37.5	24.8	15	15	14.7	12.2	12.5	12.6	12.6	4.2	5.0	8.0	10.0
AYB6-8	6	8	39.2	24.8	15	16	14.7	12.2	14.5	12.5	14.6	4.2	5.0	17.0	12.0
AYB8-8	8	8	42.9	28.8	16	16	16.4	14.2	14.6	14.6	14.6	4.2	7.0	18.0	14.0
AYB8-10	8	10	44.8	28.8	16	19	16.4	14.2	17.5	14.6	17.5	4.2	7.0	22.5	19.0
AYB10-10	10	10	48.3	35.0	19	19	18.4	17.5	17.5	17.5	17.5	4.2	9.0	27.0	24.0
AYB10-12	10	12	49.4	35.0	19	20	18.4	17.5	20.0	17.5	20.0	4.2	9.0	30.0	29.0
AYB12-12	12	12	54.0	40.0	20	20	20.3	20.0	20.0	20.0	20.0	4.2	11.0	38.5	33.0

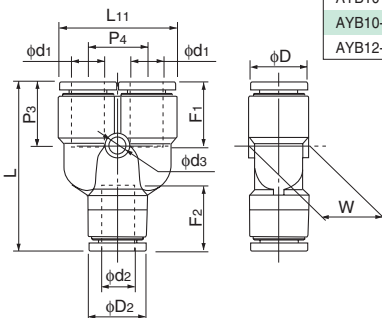

Tube

Clean tube

Processed tube

PushOne fitting

QuickSeal fitting

Clean fitting/Chemifit

Bamboo-shoot fitting

Control switch/Detachable series

Jig/Tool/Accessory

Technical information

Reference

Double Y union

●Millimeter size type



Product number	d1 Applicable tube outer diameter (mm)	d2 Applicable tube outer diameter (mm)	L (mm)	L11 (mm)	F1 Tube insertion length (mm)	F2 Tube insertion length (mm)	P3 (mm)	P4 (mm)	W (mm)	D1 (mm)	D (mm)	ds (mm)	Min. inner diameter (mm)	Effective cross- sectional area (mm ²)	Weight (g)
AUWY4-6	4	6	34.2	19.8	13	15	13.4	10.0	19.8	9.8	12.6	3.2	3.5	—	10.0
AUWY6-8	6	8	39.2	24.8	15	16	14.8	12.2	24.8	12.6	14.6	4.2	5.0	—	16.0

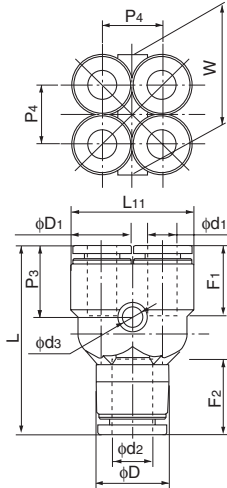

Panel touch connector

●Millimeter size type



Product number	Applicable tube outer diameter (mm)	L (mm)	F Tube insertion length (mm)	t Max. panel thickness (mm)	H4 (mm)	T1 Recommended panel hole diameter (mm)	Washer outer diameter (mm)	Washer thickness (mm)	Thread length (mm)	Min. inner diameter (mm)	Effective cross- sectional area (mm ²)	Weight (g)
APC4	4	31.8	13	8.0	17.0	13	20	2.0	20	3.0	3.5	5.0
APC6	6	33.6	15	9.5	19.0	15	24	2.5	22	5.0	12.5	7.0
APC8	8	35.8	16	10.5	22.0	17	28	2.5	23	7.0	28.0	9.0
APC10	10	41.7	19	14.0	27.0	21	34	3.0	27	9.0	45.0	16.0
APC12	12	43.6	20	16.0	30.0	23	37	3.0	29	11.0	67.0	67.0

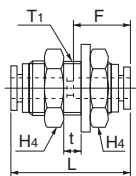

Internal panel touch connector

●Millimeter size type



Product number	Applicable tube outer diameter (mm)	T Thread size (Rc)	L (mm)	A (mm)	F Tube insertion length (mm)	H×φ Width across flat (mm)	H4 (mm)	t Max. panel thickness (mm)	T1 Recommended panel hole diameter (mm)	d1 (mm)	Washer outer diameter (mm)	Washer thickness (mm)	Min. inner diameter (mm)	Effective cross- sectional area (mm ²)	Weight (g)
APFC4-R1/8	4	Rc1/8	27.9	8.7	13	17.0×18.5	17.0	8.0	13	3.0	20	2.0	3.0	4.0	22.0
APFC6-R1/8	6	Rc1/8	29.8	8.7	15	19.0×21.0	19.0	9.0	15	5.0	24	2.5	5.0	10.5	44.0
APFC6-R1/4	6	Rc1/4	35.3	13.0	15	19.0×21.0	19.0	9.0	15	5.0	24	2.5	5.0	10.5	50.0
APFC8-R1/4	8	Rc1/4	34.4	13.0	16	22.0×24.5	22.0	10.5	17	7.0	28	2.5	7.0	25.0	64.0
APFC8-R3/8	8	Rc3/8	38.4	13.5	16	22.0×24.5	22.0	10.5	17	7.0	28	2.5	7.0	26.0	68.0
APFC10-R1/4	10	Rc1/4	40.4	13.0	19	27.0×30.0	27.0	14.0	21	9.0	34	3.0	9.0	40.0	117.0
APFC10-R3/8	10	Rc3/8	40.4	13.5	19	27.0×30.0	27.0	14.0	21	9.0	34	3.0	9.0	40.0	107.0
APFC12-R1/4	12	Rc1/4	42.3	13.0	20	30.0×33.5	30.0	16.0	23	10.5	37	3.0	10.5	45.0	147.0
APFC12-R3/8	12	Rc3/8	42.3	13.5	20	30.0×33.5	30.0	16.0	23	11.0	37	3.0	11.0	50.0	138.0

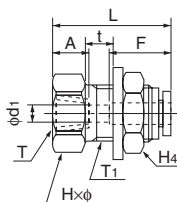

Tube

Clean tube

Processed tube

PushOne fitting

QuickSeal fitting

Clean fitting/ Chemifit

Bamboo-shoot fitting

Control switch/ Detachable series

Jig/Tool/ Accessory

Technical information

Reference

90 degree panel touch elbow

●Millimeter size type



Product number	Applicable tube outer diameter (mm)	L ₁ (mm)	L ₂ (mm)	L ₃ (mm)	L ₄ (mm)	F Tube insertion length (mm)	H×φ Width across flat (mm)	H ₄ Width across flat (mm)	t Max. panel thickness (mm)	T ₁ Recommended panel hole diameter (mm)	D (mm)	Washer outer diameter (mm)	Washer thickness (mm)	Min. inner diameter (mm)	Effective cross-sectional area (mm ²)	Weight (g)
APL4	4	17.2	35.6	27.7	40.5	13	17.0×18.3	17.0	7.5	13	9.8	21	2.5	3.0	—	32.0
APL6	6	18.5	40.0	30.5	46.3	15	19.0×21.0	19.0	9.0	15	12.6	24	2.5	5.0	—	43.0
APL8	8	20.7	43.6	34.7	47.5	16	22.0×24.5	22.0	10.0	17	14.6	28	3.0	7.0	—	62.0
APL10	10	24.7	51.6	41.7	60.3	19	27.0×30.0	27.0	14.0	21	17.5	34	3.0	9.0	—	101.0
APL12	12	26.3	56.0	44.8	66.0	20	30.0×33.5	30.0	16.0	23	20.0	37	3.0	10.0	—	126.0

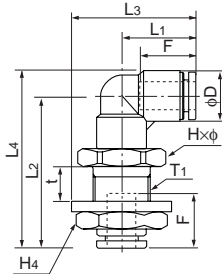

Reducer

●Millimeter size type



Product number	Applicable tube outer diameter (mm)	D ₁ Insertion part diameter (mm)	L (mm)	L ₁₀ (mm)	F Tube insertion length (mm)	D (mm)	Min. inner diameter (mm)	Effective cross-sectional area (mm ²)	Weight (g)
AR4-6	4	6	30.4	13.9	13	10.0	3.0	3.5	8.0
AR4-8	4	8	30.9	13.9	13	10.0	3.0	3.5	11.0
AR6-8	6	8	31.8	14.8	15	12.0	5.0	10.5	11.0
AR6-10	6	10	34.3	15.8	15	12.0	5.0	10.5	17.0
AR6-12	6	12	35.8	15.8	15	13.0	5.0	10.5	25.0
AR8-10	8	10	34.9	16.4	16	13.9	7.0	28.0	15.0
AR8-12	8	12	36.4	16.4	16	13.9	7.0	28.0	22.0
AR10-12	10	12	41.4	21.4	19	16.9	7.0	45.0	23.0

⚠ Caution: Once a reducer is inserted into a PushOne part, the part cannot be used to connect a tube.

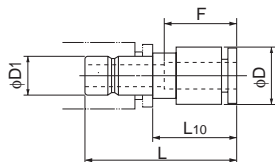

Adopter elbow

●Millimeter size type



Product number	Applicable tube outer diameter (mm)	D ₁ Insertion part diameter (mm)	L ₁ (mm)	L ₂ (mm)	L ₃ (mm)	L ₄ (mm)	L ₁₀ (mm)	F Tube insertion length (mm)	D (mm)	Min. inner diameter (mm)	Effective cross-sectional area (mm ²)	Weight (g)
AAL4	4	4	17.2	30.7	22.1	35.6	14.7	13	9.8	3.0	4.0	6.0
AAL6	6	6	18.5	34.2	24.4	40.5	17.7	15	12.6	4.5	12.0	10.0
AAL8	8	8	20.7	35.7	27.6	43.0	18.7	16	14.6	6.0	20.0	14.0
AAL10	10	10	24.7	41.2	33.0	50.0	22.7	19	17.5	8.0	35.0	22.0
AAL12	12	12	26.3	45.2	35.7	55.2	25.2	20	20.0	10.0	43.0	30.0

⚠ Caution: Once an adopter elbow is inserted into a PushOne part, the part cannot be used to connect a tube.

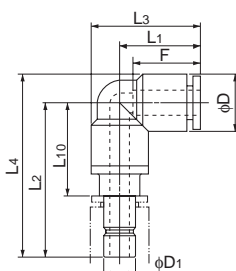

Y plug

●Millimeter size type



Product number	Applicable tube outer diameter (mm)	D ₁ Insertion part diameter (mm)	L (mm)	L ₁₀ (mm)	L ₁₁ (mm)	F Tube insertion length (mm)	P ₃ (mm)	P ₄ (mm)	W (mm)	D (mm)	d ₂ (mm)	Min. inner diameter (mm)	Effective cross-sectional area (mm ²)	Weight (g)
AYA4-4	4	4	48.4	32.4	20.8	13	13.5	11.0	9.8	9.8	3.2	3.0	3.5	8.0
AYA6-6	6	6	52.8	36.3	24.8	15	14.7	12.2	12.6	12.6	4.2	4.5	9.0	14.0
AYA8-8	8	8	56.4	39.4	28.8	16	16.4	14.2	14.6	14.6	4.2	6.0	18.0	19.0
AYA10-10	10	10	63.9	45.4	35.0	19	18.4	17.5	17.5	17.5	4.2	8.0	28.0	31.0
AYA12-12	12	12	70.3	50.3	40.0	20	20.3	20.0	20.0	20.0	4.2	10.0	40.0	42.0

⚠ Caution: Once a Y plug elbow is inserted into a PushOne part, the part cannot be used to connect a tube.

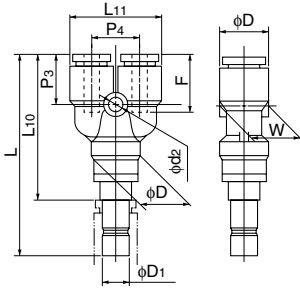

Manifold A type

●Millimeter size type



Product number	Applicable tube outer diameter (mm)		A Number of ports	L (mm)	L ₁ (mm)	L ₂ (mm)	L ₃ (mm)	L ₄ (mm)	L ₅ (mm)	L ₆ (mm)	L ₇ (mm)	L ₈ (mm)	F ₁ Tube insertion length (mm)	F ₂ Tube insertion length (mm)	P ₁ (mm)	d ₁ (mm)	d ₂ (mm)	Effective cross-sectional area (mm ²)	Weight (g)
	Port A	Port B																	
AMA4-8-6	4	8	6	61.0	30.5	36.0	10.0	18.2	27.5	18.2	9.3	18.5	13	16	10.6	9.7	14.5	—	20.0
AMA4-8-10	4	8	10	82.2	41.1	57.2	10.0	18.2	27.5	18.2	9.3	18.5	13	16	10.6	9.7	14.5	—	33.0
AMA6-10-6	6	10	6	73.7	36.9	44.0	11.5	20.2	29.5	20.2	9.3	18.5	15	19	13.0	12.5	17.5	—	37.0
AMA6-10-10	6	10	10	99.7	49.9	70.0	11.5	20.2	29.5	20.2	9.3	18.5	15	19	13.0	12.5	17.5	—	54.0
AMA8-12-6	8	12	6	83.2	41.6	51.0	12.5	22.1	32.6	22.1	10.5	21.0	16	20	15.5	14.5	20.0	—	50.0
AMA8-12-10	8	12	10	114.2	57.1	82.0	12.5	22.1	32.6	22.1	10.5	21.0	16	20	15.5	14.5	20.0	—	68.0

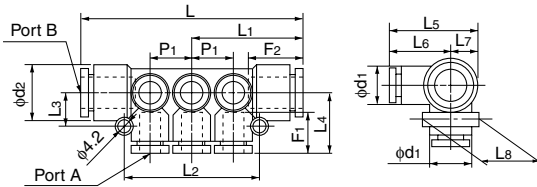

Manifold B type

●Millimeter size type



Product number	Applicable tube outer diameter (mm)		Thread size (Rc)	A Number of ports	L (mm)	L ₁ (mm)	L ₂ (mm)	L ₃ (mm)	L ₄ (mm)	L ₅ (mm)	L ₆ (mm)	L ₇ (mm)	L ₈ (mm)	F ₁ Tube insertion length (mm)	P ₁ (mm)	d ₁ (mm)	Hxφ Width across flat (mm)	Effective cross-sectional area (mm ²)	Weight (g)
	Port A	Port B																	
AMB4-1/4-6	4	Rc1/4	6	84.0	42.0	36.0	10.0	18.2	27.5	18.2	9.3	18.5	13	10.6	9.7	17.0x18.5	—	58.0	
AMB4-1/4-10	4	Rc1/4	10	105.2	52.6	57.2	10.0	18.2	27.5	18.2	9.3	18.5	13	10.6	9.7	17.0x18.5	—	67.0	
AMB6-1/4-6	6	Rc1/4	6	96.4	48.2	44.0	11.5	20.2	29.5	20.2	9.3	18.5	15	13.0	12.5	17.0x18.5	—	79.0	
AMB6-1/4-10	6	Rc1/4	10	122.4	61.2	70.0	11.5	20.2	29.5	20.2	9.3	18.5	15	13.0	12.5	17.0x18.5	—	96.0	
AMB8-3/8-6	8	Rc3/8	6	105.6	52.8	51.0	12.5	22.1	32.6	22.1	10.5	21.0	16	15.5	14.5	19.0x21.0	—	92.0	
AMB8-3/8-10	8	Rc3/8	10	136.6	68.3	82.0	12.5	22.1	32.6	22.1	10.5	21.0	16	15.5	14.5	19.0x21.0	—	117.0	

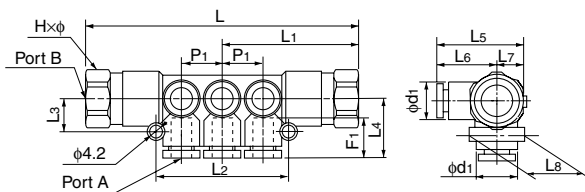

Tube
Clean tube
Processed tube
PushOne fitting
QuickSeal fitting
Clean fitting/ Chemifit
Bamboo-shoot fitting
Control switch/ Detachable series
Jig/Tool/ Accessory
Technical information
Reference

Tube cap

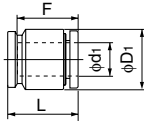

●Millimeter size type

Product number	d ₁ Applicable tube outer diameter (mm)	D ₁ (mm)	F Tube insertion length (mm)	L (mm)	Weight (g)
ACC4	4	9.8	13	15.0	2.0
ACC6	6	12.6	15	16.9	3.0
ACC8	8	14.6	16	17.9	4.0
ACC10	10	17.5	19	21.7	6.0
ACC12	12	20.0	20	22.6	8.0

Blank plug

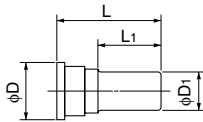

●Millimeter size type

Product number	D ₁ Insertion part diameter (mm)	L (mm)	L ₁ (mm)	D (mm)	Weight (g)
BC4	4	28.0	15.5	7.7	0.75
BC6	6	28.0	16.0	9.7	1.2
BC8	8	29.0	16.0	11.7	1.7
BC10	10	32.0	17.7	14.0	2.5
BC12	12	34.0	20.4	16.0	3.8

Nipple

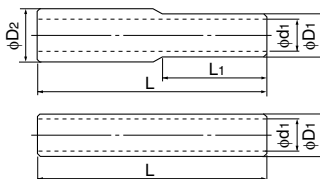

●Millimeter size type

Product number	D ₁ Insertion part diameter (mm)	D ₂ Insertion part diameter (mm)	d ₁ (mm)	L (mm)	L ₁ (mm)	Weight (g)
EN4	4	—	2.5	37.0	—	1.0
EN4-6	4	6	2.5	38.0	18.5	1.0
EN6	6	—	4.0	39.0	—	1.0
EN6-8	8	6	4.0	41.0	19.5	1.0
EN8	8	—	6.0	43.0	—	1.0
EN8-10	8	10	6.0	46.0	21.5	2.0
EN10	10	—	7.5	49.0	—	2.0
EN10-12	10	12	7.5	50.5	24.5	3.0
EN12	12	—	9.0	52.0	—	3.0

Tube

Clean tube

Processed tube

PushOne fitting

QuickSeal fitting

Clean fitting/Chemifit

Bamboo-shoot fitting

Control switch/Detachable series

Jig/Tool/Accessory

Technical information

Reference

PushOne® E Series

PushOne® fittings for general air pressure (flame resistant)

Features

- **PushOne® connection of tube**
The tubes can be connected without using a jig or tools
- **Electroless nickel plated**
Preventing degradation of surface and dissolution of copper ions in fluid
- **Flame-resistant resin (compliant V-0 of UL94 standard)**
Made of flame-resistant resin PBT. High self-extinguishing performance is compliant with V-0 of UL94 standard. Usable under an environment with spatters.
- **Sealing-processed R thread.**
Sealing tape is not required.



Cross-sectional structure diagram

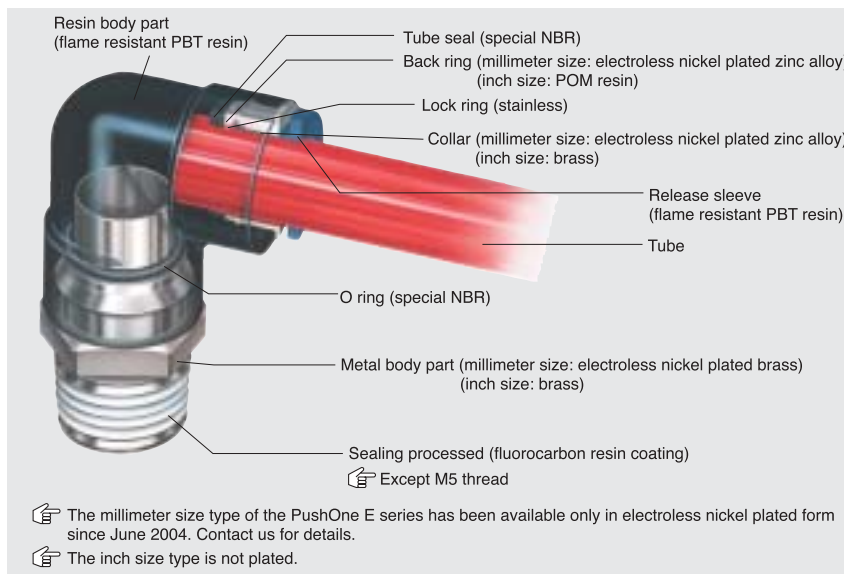

Product number example

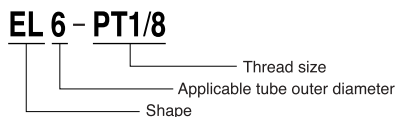

Distinction of millimeter/inch sizes



Operating fluid, working temperature range

Operating fluid	Working temperature range
Air	-20°C~+80°C
Water	0°C~+40°C

ⓘ See "Combination List of Tube and Fitting" on page 8.





Pressure condition

Maximum working pressure: 1.0MPa
Negative pressure performance:
-99.975kPa

Handling instructions

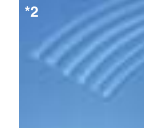

- ⚠ **Caution** When the working conditions of tubes and fittings differ, use them under the lower specified conditions.
 - ⚠ **Caution** When water is used as the operating fluid, confirm that there is no water leakage damage to equipment and instruments due to construction failure.
 - ⚠ **Caution** When water is used as the operating fluid, do not allow it to freeze.
 - ⚠ **Caution** Do not bend the pipe sharply near the tube insertion port of the fitting. Keep the tube straight for twice as long as the tube diameter from the insertion port.
- ⓘ See page 34 for the common handling instructions for tube fittings.

Applicable tube

Polyurethane tube	Nylon tube	Flame-resistant tube	Antistatic tube	Polyolefine resin tube	Fluorocarbon resin tube
					
U2***P.12 U1***P.13 U5***P.14	N2***P.15 N5***P.16 N1***P.17	FS*****P.20 FW*****P.21 FWU***P.22	UE***P.23	PL***P.26 PN***P.27	TA***P.28 TP***P.29

(*1) When the PushOne E series is used with a UE tube, choose a metal body type including a connector and a hexagonal socket to maintain conductivity between the tube and the fittings.
(*2) Combinatory use of PL, PN, TA or TP tube and PushOne E series mixes general and clean type performances. When using them in a clean environment, pay attention to the clean level that could be lowered.

Allied products and product introduction

 P.144	 P.151	 P.156	 P.159	 P.160	 P.169
--	--	--	--	--	---

Reference

Instruction manualP.178
UL-94 standard flame testP.204
Effective cross-sectional areaP.176
Negative-pressure performance listP.177

Tube
Clean tube
Processed tube
PushOne fitting
QuickSeal fitting
Clean fitting/Chemifit
Bamboo-shoot fitting
Control switch/Detachable series
Jig/Tool/Accessory
Technical information
Reference

PushOne® E Series

Shape list



Tube

Clean tube

Processed tube

PushOne fitting

QuickSeal fitting

Clean fitting/Chemifit

Bamboo-shoot fitting

Control switch/Detachable series

Jig/Tool/Accessory

Technical information

Reference

Connector



Millimeter size type

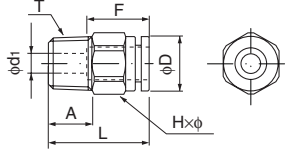

Inch size type

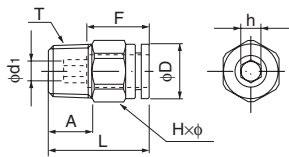

M thread

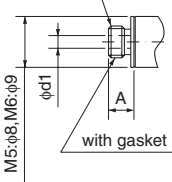

●Millimeter size type

Product number	Applicable tube outer diameter (mm)	T Thread size (M,R)	L (mm)	A (mm)	F Tube insertion length (mm)	H×φ Width across flat (mm)	D (mm)	d ₁ (mm)	Effective cross-sectional area (mm ²)	Weight (g)
EC4-M5	4	M5×0.8	22.4	4.0	13	10.0×11.0	9.6	2.0	3.0	6.0
EC4-PT1/8	4	R1/8	19.4	8.0	13	10.0×11.0	9.6	2.5	4.0	7.0
EC4-PT1/4	4	R1/4	22.4	11.0	13	14.0×15.4	9.6	2.5	4.0	17.0
EC6-M5	6	M5×0.8	24.2	4.0	15	12.0×13.0	11.7	2.0	3.5	9.0
EC6-M6	6	M6×1.0	25.2	5.0	15	12.0×13.0	11.7	3.0	4.5	10.0
EC6-PT1/8	6	R1/8	21.2	8.0	15	12.0×13.0	11.7	4.0	10.5	9.0
EC6-PT1/4	6	R1/4	24.2	11.0	15	14.0×15.4	11.7	4.0	10.5	18.0
EC6-PT3/8	6	R3/8	25.2	12.0	15	17.0×18.5	11.7	4.0	10.5	32.0
EC8-PT1/8	8	R1/8	26.2	8.0	16	14.0×15.4	13.7	5.0	20.0	14.0
EC8-PT1/4	8	R1/4	25.2	11.0	16	14.0×15.4	13.7	6.0	25.0	16.0
EC8-PT3/8	8	R3/8	26.2	12.0	16	17.0×18.5	13.7	6.0	26.0	29.0
EC10-PT1/8	10	R1/8	30.1	8.0	19	17.0×18.5	16.7	5.0	25.0	24.0
EC10-PT1/4	10	R1/4	28.1	11.0	19	17.0×18.5	16.7	8.0	40.0	21.0
EC10-PT3/8	10	R3/8	29.1	12.0	19	17.0×18.5	16.7	8.0	40.0	29.0
EC10-PT1/2	10	R1/2	32.1	15.0	19	22.0×24.5	16.7	8.0	40.0	61.0
EC12-PT1/4	12	R1/4	34.0	11.0	20	19.0×21.0	18.6	8.0	45.0	32.0
EC12-PT3/8	12	R3/8	30.0	12.0	20	19.0×21.0	18.6	10.0	50.0	31.0
EC12-PT1/2	12	R1/2	33.0	15.0	20	22.0×24.5	18.6	10.0	50.0	58.0
EC16-PT3/8	16	R3/8	41.6	12.0	27	24.0×26.5	24.5	10.0	77.0	68.0
EC16-PT1/2	16	R1/2	43.6	15.0	27	24.0×26.5	24.5	12.0	110.5	83.0

*Made to order

●Inch size type

Product number	Applicable tube outer diameter (inch)	T Thread size (M,R)	L (mm)	A (mm)	F Tube insertion length (mm)	H×φ Width across flat (mm)	h Width across flat (mm)	D (mm)	d ₁ (mm)	Effective cross-sectional area (mm ²)	Weight (g)
EC1/4-M5	1/4	M5×0.8	24.4	4.0	15	12.0×13.0	4.0	12.0	2.0	3.5	9.0
EC1/4-PT1/8	1/4	R1/8	21.4	8.0	15	12.0×13.0	4.0	12.0	4.0	12.0	9.0
EC1/4-PT1/4	1/4	R1/4	24.4	11.0	15	14.0×15.4	4.0	12.0	4.0	12.0	18.0
EC1/4-PT3/8	1/4	R3/8	25.4	12.0	15	17.0×18.5	4.0	12.0	4.0	12.0	32.0
EC5/16-PT1/8	5/16	R1/8	25.9	8.0	16	14.0×15.4	5.0	13.9	5.0	20.0	14.0
EC5/16-PT1/4	5/16	R1/4	24.9	11.0	16	14.0×15.4	6.0	13.9	6.0	25.0	16.0
EC5/16-PT3/8	5/16	R3/8	25.9	12.0	16	17.0×18.5	6.0	13.9	6.0	26.0	29.0
EC3/8-PT1/8	3/8	R1/8	29.7	8.0	19	17.0×18.5	—	16.9	5.0	20.0	24.0
EC3/8-PT1/4	3/8	R1/4	27.7	11.0	19	17.0×18.5	—	16.9	8.0	35.0	21.0
EC3/8-PT3/8	3/8	R3/8	28.7	12.0	19	17.0×18.5	—	16.9	8.0	35.0	29.0
EC3/8-PT1/2	3/8	R1/2	31.7	15.0	19	22.0×24.5	—	16.9	8.0	35.0	61.0
EC1/2-PT1/4	1/2	R1/4	34.0	11.0	21	19.0×21.0	—	19.0	8.0	48.0	32.0
EC1/2-PT3/8	1/2	R3/8	30.0	12.0	21	19.0×21.0	—	19.0	10.0	66.5	31.0
EC1/2-PT1/2	1/2	R1/2	33.0	15.0	21	22.0×24.5	—	19.0	10.0	66.5	58.0

☞ The inch size type is not plated.

Hexagon socket connector

●Millimeter size type

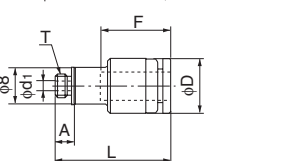
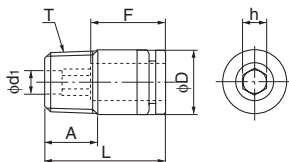

Product number	Applicable tube outer diameter (mm)	T Thread size (M,R)	L (mm)	A (mm)	F Tube insertion length (mm)	h Width across flat (mm)	D (mm)	d ₁ (mm)	Effective cross-sectional area (mm ²)	Weight (g)
EC4-M5A	4	M5×0.8	19.4	4.0	13	2.0	9.8	2.0	—	5.0
EC4-PT1/8A	4	R1/8	19.4	8.0	13	2.5	9.8	2.5	—	7.0
EC6-M5A	6	M5×0.8	24.2	4.0	15	4.0	11.8	2.0	—	18.0
EC6-PT1/8A	6	R1/8	21.2	8.0	15	4.0	11.8	4.0	—	8.0
EC6-PT1/4A	6	R1/4	24.2	11.0	15	4.0	13.8	4.0	—	17.0
EC6-PT1/8A	8	R1/8	26.2	8.0	16	5.0	13.8	5.0	—	12.0
EC8-PT1/4A	8	R1/4	25.2	11.0	16	5.0	13.8	5.0	—	15.0
EC10-PT1/4A	10	R1/4	28.1	11.0	19	6.0	16.8	6.0	—	19.0
EC10-PT3/8A	10	R3/8	29.1	12.0	19	6.0	16.8	6.0	—	28.0

Tube
Clean tube
Processed tube
PushOne fitting
QuickSeal fitting
Clean fitting/Chemifit
Bamboo-shoot fitting
Control switch/Detachable series
Jig/Tool/Accessory
Technical information
Reference

Internal connector

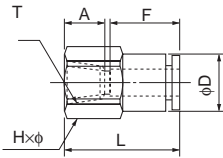

●Millimeter size type

Product number	Applicable tube outer diameter (mm)	T Thread size (Rc)	L (mm)	A (mm)	F Tube insertion length (mm)	Hxφ Width across flat (mm)	D (mm)	Min. inner diameter (mm)	Effective cross-sectional area (mm ²)	Weight (g)
EFC4-PT1/8	4	Rc1/8	23.9	8.7	13	14.0x15.4	10.0	3.0	4.0	16.0
EFC6-PT1/8	6	Rc1/8	24.8	8.7	15	14.0x15.4	12.0	5.0	10.5	17.0
EFC6-PT1/4	6	Rc1/4	29.3	13.0	15	17.0x18.5	12.0	5.0	10.5	26.0
EFC8-PT1/4	8	Rc1/4	30.9	13.0	16	17.0x18.5	13.9	7.0	25.0	28.0
EFC8-PT3/8	8	Rc3/8	31.4	13.5	16	22.0x24.5	13.9	7.0	26.0	45.0
EFC10-PT1/4	10	Rc1/4	33.9	13.0	19	17.0x18.5	16.9	9.0	40.0	34.0
EFC10-PT3/8	10	Rc3/8	34.4	13.5	19	22.0x24.5	16.9	9.0	40.0	50.0
EFC10-PT1/2	10	Rc1/2	38.4	17.5	19	24.0x26.5	16.9	9.0	40.0	56.0
EFC12-PT1/4	12	Rc1/4	34.5	13.0	20	19.0x21.0	19.0	10.0	45.0	43.0
EFC12-PT3/8	12	Rc3/8	35.3	13.5	20	22.0x24.5	19.0	11.0	50.0	50.0
EFC12-PT1/2	12	Rc1/2	39.3	17.5	20	24.0x26.5	19.0	11.0	50.0	58.0

●Inch size type

Product number	Applicable tube outer diameter (inch)	T Thread size (Rc)	L (mm)	A (mm)	F Tube insertion length (mm)	Hxφ Width across flat (mm)	D (mm)	Min. inner diameter (mm)	Effective cross-sectional area (mm ²)	Weight (g)
EFC1/4-PT1/8	1/4	Rc1/8	25.0	8.7	15	14.0x15.4	12.0	5.0	12.0	17.0
EFC1/4-PT1/4	1/4	Rc1/4	29.5	13.0	15	17.0x18.5	12.0	5.0	12.0	26.0
EFC5/16-PT1/4	5/16	Rc1/4	30.6	13.0	16	17.0x18.5	13.9	7.0	25.0	28.0
EFC5/16-PT3/8	5/16	Rc3/8	31.1	13.5	16	22.0x24.5	13.9	7.0	26.0	45.0
EFC3/8-PT1/4	3/8	Rc1/4	33.5	13.0	19	17.0x18.5	16.9	9.0	35.0	34.0
EFC3/8-PT3/8	3/8	Rc3/8	34.0	13.5	19	22.0x24.5	16.9	9.0	35.0	50.0
EFC3/8-PT1/2	3/8	Rc1/2	38.4	17.5	19	24.0x26.5	16.9	9.0	35.0	56.0
EFC1/2-PT1/4	1/2	Rc1/4	35.3	13.0	21	22.0x24.5	20.0	10.0	48.0	43.0
EFC1/2-PT3/8	1/2	Rc3/8	35.3	13.5	21	22.0x24.5	20.0	11.0	66.5	50.0
EFC1/2-PT1/2	1/2	Rc1/2	39.3	17.5	21	24.0x26.5	20.0	11.0	66.5	58.0

The inch size type is not plated.

90 degree elbow

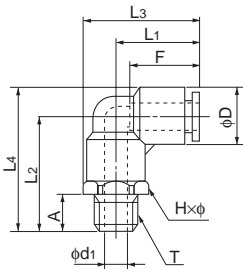

M thread

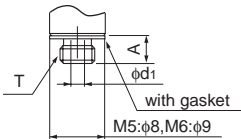

●Millimeter size type

Product number	Applicable tube outer diameter (mm)	T Thread size (M,R)	L ₁ (mm)	L ₂ (mm)	L ₃ (mm)	L ₄ (mm)	A (mm)	F Tube insertion length (mm)	Hxφ Width across flat (mm)	D (mm)	d ₁ (mm)	Min. inner diameter (mm)	Effective cross-sectional area (mm ²)	Weight (g)
EL4-M5	4	M5x0.8	17.2	20.2	22.7	25.1	4.0	13	10.0x11.0	9.8	2.0	2.0	3.0	7.0
EL4-PT1/8	4	R1/8	17.2	22.7	22.7	27.6	8.0	13	10.0x11.0	9.8	5.0	3.0	4.0	9.0
EL4-PT1/4	4	R1/4	17.2	26.7	24.9	31.6	11.0	13	14.0x15.4	9.8	7.0	3.0	4.0	16.0
EL6-M5	6	M5x0.8	18.5	22.7	25.0	29.0	4.0	15	12.0x13.0	12.6	2.0	2.0	3.5	10.0
EL6-M6	6	M6x1.0	18.5	22.7	25.0	29.0	5.0	15	12.0x13.0	12.6	3.0	3.0	4.5	11.0
EL6-PT1/8	6	R1/8	18.5	25.2	25.0	31.5	8.0	15	12.0x13.0	12.6	5.0	5.0	12.0	18.0
EL6-PT1/4	6	R1/4	18.5	29.2	26.2	35.5	11.0	15	14.0x15.4	12.6	7.0	5.0	12.0	18.0
EL6-PT3/8	6	R3/8	18.5	30.2	27.8	36.5	12.0	15	17.0x18.5	12.6	9.0	5.0	12.0	26.0
EL8-PT1/8	8	R1/8	20.7	26.2	28.4	33.5	8.0	16	14.0x15.4	14.5	5.0	5.0	18.5	15.0
EL8-PT1/4	8	R1/4	20.7	30.2	28.4	37.5	11.0	16	14.0x15.4	14.5	7.0	7.0	23.0	20.0
EL8-PT3/8	8	R3/8	20.7	31.2	30.0	38.5	12.0	16	17.0x18.5	14.5	9.0	7.0	23.0	28.0
EL10-PT1/8	10	R1/8	24.7	29.2	33.9	38.0	8.0	19	17.0x18.5	17.5	5.0	5.0	22.0	22.0
EL10-PT1/4	10	R1/4	24.7	33.2	33.9	42.0	11.0	19	17.0x18.5	17.5	7.0	7.0	34.5	27.0
EL10-PT3/8	10	R3/8	24.7	34.2	33.9	43.0	12.0	19	17.0x18.5	17.5	9.0	9.0	37.0	33.0
EL10-PT1/2	10	R1/2	24.7	38.2	36.9	47.0	15.0	19	22.0x24.5	17.5	12.0	9.0	37.0	52.0
EL12-PT1/4	12	R1/4	26.3	35.7	36.8	45.7	11.0	20	19.0x21.0	20.0	7.0	7.0	36.0	34.0
EL12-PT3/8	12	R3/8	26.3	36.7	36.8	46.7	12.0	20	19.0x21.0	20.0	9.0	9.0	43.0	39.0
EL12-PT1/2	12	R1/2	26.3	40.7	38.6	50.7	15.0	20	22.0x24.5	20.0	12.0	10.0	43.0	56.0
EL16-PT3/8	16	R3/8	34.9	45.0	48.4	58.8	12.0	27	24.0x27.0	28.0	11.0	11.0	70.0	70.0
EL16-PT1/2	16	R1/2	34.9	48.0	48.4	61.8	15.0	27	24.0x27.0	28.0	12.0	12.0	93.0	84.0

*Made to order

●Inch size type

Product number	Applicable tube outer diameter (inch)	T Thread size (M,R)	L ₁ (mm)	L ₂ (mm)	L ₃ (mm)	L ₄ (mm)	A (mm)	F Tube insertion length (mm)	Hxφ Width across flat (mm)	D (mm)	d ₁ (mm)	Min. inner diameter (mm)	Effective cross-sectional area (mm ²)	Weight (g)
EL1/4-M5	1/4	M5x0.8	18.1	22.7	24.6	29.0	4.0	15	12.0x13.0	13.0	2.0	2.0	3.0	10.0
EL1/4-PT1/8	1/4	R1/8	18.1	25.2	24.6	31.5	8.0	15	12.0x13.0	13.0	5.0	5.0	13.0	18.0
EL1/4-PT1/4	1/4	R1/4	18.1	29.2	25.8	35.5	11.0	15	14.0x15.4	13.0	7.0	5.0	13.0	18.0
EL1/4-PT3/8	1/4	R3/8	18.1	30.2	27.4	36.5	12.0	15	17.0x18.5	13.0	9.0	5.0	13.0	26.0
EL5/16-PT1/8	5/16	R1/8	20.6	26.2	28.3	33.5	8.0	16	14.0x15.4	15.0	5.0	5.0	18.5	15.0
EL5/16-PT1/4	5/16	R1/4	20.6	30.2	28.3	37.5	11.0	16	14.0x15.4	15.0	7.0	7.0	23.0	20.0
EL5/16-PT3/8	5/16	R3/8	20.6	31.2	29.9	38.5	12.0	16	17.0x18.5	15.0	9.0	7.0	23.0	28.0
EL3/8-PT1/8	3/8	R1/8	24.4	29.2	33.7	38.0	8.0	19	17.0x18.5	18.0	5.0	5.0	19.0	22.0
EL3/8-PT1/4	3/8	R1/4	24.4	33.2	33.7	42.0	11.0	19	17.0x18.5	18.0	7.0	7.0	30.0	27.0
EL3/8-PT3/8	3/8	R3/8	24.4	34.2	33.7	43.0	12.0	19	17.0x18.5	18.0	9.0	9.0	32.0	33.0
EL3/8-PT1/2	3/8	R1/2	24.4	38.2	36.7	47.0	15.0	19	22.0x24.5	18.0	12.0	9.0	32.0	52.0
EL1/2-PT1/4	1/2	R1/4	26.5	35.7	37.0	46.2	11.0	21	19.0x21.0	21.5	7.0	7.0	37.0	34.0
EL1/2-PT3/8	1/2	R3/8	26.5	36.7	37.0	47.2	12.0	21	19.0x21.0	21.5	9.0	9.0	53.0	39.0
EL1/2-PT1/2	1/2	R1/2	26.5	40.7	38.7	51.2	15.0	21	22.0x24.5	21.5	12.0	10.0	55.5	56.0

The inch size type is not plated.

90 degree internal elbow

●Millimeter size type

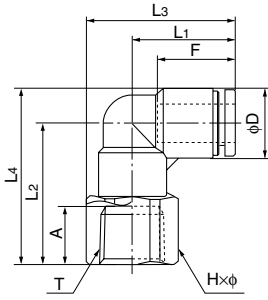

Product number	Applicable tube outer diameter (mm)	T Thread size (Rc)	L1 (mm)	L2 (mm)	L3 (mm)	L4 (mm)	A (mm)	F Tube insertion length (mm)	H×φ Width across flat (mm)	D (mm)	Min. inner diameter (mm)	Effective cross-sectional area (mm ²)	Weight (g)
EFL4-PT1/8	4	Rc1/8	17.2	21.7	24.9	22.1	8.0	13	14.0×15.4	9.8	3.0	—	13.0
EFL6-PT1/8	6	Rc1/8	18.5	24.2	26.2	30.5	8.0	15	14.0×15.4	12.6	5.0	—	15.0
EFL6-PT1/4	6	Rc1/4	18.5	28.2	27.8	34.5	12.0	15	17.0×18.5	12.6	5.0	—	23.0
EFL8-PT3/8	6	Rc3/8	18.5	28.7	30.8	35.0	12.5	15	22.0×24.5	12.6	5.0	—	37.0
EFL8-PT1/8	8	Rc1/8	20.7	25.2	28.4	32.5	8.0	16	14.0×15.4	14.6	7.0	—	17.0
EFL8-PT1/4	8	Rc1/4	20.7	29.2	30.0	36.5	12.0	16	17.0×18.5	14.6	7.0	—	25.0
EFL8-PT3/8	8	Rc3/8	20.7	29.7	33.0	37.0	12.5	16	22.0×24.5	14.6	7.0	—	38.0
EFL10-PT1/4	10	Rc1/4	24.7	32.2	34.0	41.0	12.0	19	17.0×18.5	17.5	9.0	—	29.0
EFL10-PT3/8	10	Rc3/8	24.7	33.7	37.0	42.5	12.5	19	22.0×24.5	17.5	9.0	—	45.0
EFL12-PT3/8	12	Rc3/8	26.3	36.2	38.6	46.2	12.5	20	22.0×24.5	20.0	10.0	—	49.0
EFL12-PT1/2	12	Rc1/2	26.3	39.2	39.6	49.2	15.5	20	24.0×26.5	20.0	10.0	—	54.0

90 degree long elbow

●Millimeter size type

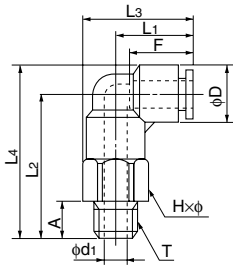

Product number	Applicable tube outer diameter (mm)	T Thread size (M,R)	L1 (mm)	L2 (mm)	L3 (mm)	L4 (mm)	A (mm)	F Tube insertion length (mm)	H×φ Width across flat (mm)	D (mm)	d1 (mm)	Min. inner diameter (mm)	Effective cross-sectional area (mm ²)	Weight (g)
ELL4-M5	4	M5×0.8	17.2	29.9	22.7	34.8	4.0	13	10.0×11.0	9.8	2.0	2.0	3.0	13.0
ELL4-PT1/8	4	R1/8	17.2	32.4	22.7	37.3	8.0	13	10.0×11.0	9.8	5.0	3.0	4.0	14.0
ELL4-PT1/4	4	R1/4	17.2	36.4	24.9	41.3	11.0	13	14.0×15.4	9.8	7.0	3.0	4.0	27.0
ELL6-M5	6	M5×0.8	18.5	34.7	25.0	41.0	4.0	15	12.0×13.0	12.6	2.0	2.0	3.5	20.0
ELL6-PT1/8	6	R1/8	18.5	37.2	25.0	43.5	8.0	15	12.0×13.0	12.6	5.0	5.0	12.0	22.0
ELL6-PT1/4	6	R1/4	18.5	41.2	26.2	47.5	11.0	15	14.0×15.4	12.6	7.0	5.0	12.0	31.0
ELL6-PT3/8	6	R3/8	18.5	42.2	27.8	48.5	12.0	15	17.0×18.5	12.6	9.0	5.0	12.0	45.0
ELL8-PT1/8	8	R1/8	20.7	40.2	28.4	47.5	8.0	16	14.0×15.4	14.6	5.0	5.0	18.5	30.0
ELL8-PT1/4	8	R1/4	20.7	44.2	28.4	51.5	11.0	16	14.0×15.4	14.6	7.0	7.0	23.0	35.0
ELL8-PT3/8	8	R3/8	20.7	45.2	30.0	52.5	12.0	16	17.0×18.5	14.6	9.0	7.0	23.0	50.0
ELL10-PT1/8	10	R1/8	24.7	46.2	33.9	55.0	8.0	19	17.0×18.5	17.5	5.0	5.0	22.0	48.0
ELL10-PT1/4	10	R1/4	24.7	50.2	33.9	59.0	11.0	19	17.0×18.5	17.5	7.0	7.0	34.5	53.0
ELL10-PT3/8	10	R3/8	24.7	51.2	33.9	60.0	12.0	19	17.0×18.5	17.5	9.0	9.0	37.0	59.0
ELL10-PT1/2	10	R1/2	24.7	55.2	36.9	64.0	15.0	19	22.0×24.5	17.5	12.0	9.0	37.0	94.0
ELL12-PT1/4	12	R1/4	26.3	55.2	36.8	65.2	11.0	20	19.0×21.0	20.0	7.0	7.0	36.0	72.0
ELL12-PT3/8	12	R3/8	26.3	56.2	36.8	66.2	12.0	20	19.0×21.0	20.0	9.0	9.0	43.0	78.0
ELL12-PT1/2	12	R1/2	26.3	60.2	38.6	70.2	15.0	20	22.0×24.5	20.0	12.0	10.0	43.0	105.0

●Inch size type

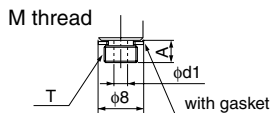

Product number	Applicable tube outer diameter (inch)	T Thread size (M,R)	L1 (mm)	L2 (mm)	L3 (mm)	L4 (mm)	A (mm)	F Tube insertion length (mm)	H×φ Width across flat (mm)	D (mm)	d1 (mm)	Min. inner diameter (mm)	Effective cross-sectional area (mm ²)	Weight (g)
ELL1/4-M5	1/4	M5×0.8	18.1	34.7	24.6	41.0	4.0	15	12.0×13.0	13.0	2.0	2.0	3.0	20.0
ELL1/4-PT1/8	1/4	R1/8	18.1	37.2	24.6	43.5	8.0	15	12.0×13.0	13.0	5.0	5.0	13.0	22.0
ELL1/4-PT1/4	1/4	R1/4	18.1	41.2	25.8	47.5	11.0	15	14.0×15.4	13.0	7.0	5.0	13.0	31.0
ELL5/16-PT1/8	5/16	R1/8	20.6	40.2	28.3	47.5	8.0	16	14.0×15.4	15.0	5.0	5.0	18.5	30.0
ELL5/16-PT1/4	5/16	R1/4	20.6	44.2	28.3	51.5	11.0	16	14.0×15.4	15.0	7.0	7.0	23.0	35.0
ELL5/16-PT3/8	5/16	R3/8	24.4	45.2	29.9	52.5	12.0	19	17.0×18.5	18.0	9.0	7.0	—	—
ELL3/8-PT1/4	3/8	R1/4	24.4	50.2	33.7	59.0	11.0	19	17.0×18.5	18.0	7.0	7.0	30.0	53.0
ELL3/8-PT3/8	3/8	R3/8	24.4	51.2	33.7	60.0	12.0	19	17.0×18.5	18.0	9.0	9.0	32.0	59.0
ELL1/2-PT1/4	1/2	R1/4	26.5	55.2	37.0	65.7	11.0	21	19.0×21.0	21.5	7.0	7.0	37.0	72.0
ELL1/2-PT3/8	1/2	R3/8	26.5	56.2	37.0	66.7	12.0	21	19.0×21.0	21.5	9.0	9.0	53.0	78.0
ELL1/2-PT1/2	1/2	R1/2	26.5	60.2	38.7	70.7	15.0	21	22.0×24.5	21.5	12.0	10.0	55.5	105.0

☞ The inch size type is not plated.

Tube
Clean tube
Processed tube
PushOne fitting
QuickSeal fitting
Clean fitting/Chemifit
Bamboo-shoot fitting
Control switch/Detachable series
Jig/Tool/Accessory
Technical information
Reference

45 degree elbow

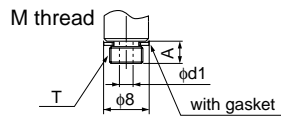
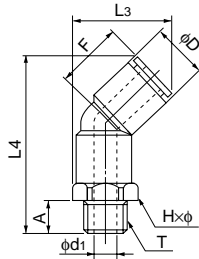

●Millimeter size type

Product number	Applicable tube outer diameter (mm)	T Thread size (M,R)	L3 (mm)	L4 (mm)	A (mm)	F Tube insertion length (mm)	H×φ Width across flat (mm)	D (mm)	d1 (mm)	Min. inner diameter (mm)	Effective cross-sectional area (mm ²)	Weight (g)
E45L4-M5	4	M5×0.8	19.7	34.4	4.0	13	10.0×11.0	9.8	2.0	2.0	3.0	7.0
E45L4-PT1/8	4	R1/8	19.7	36.9	8.0	13	10.0×11.0	9.8	5.0	3.0	4.0	9.0
E45L4-PT1/4	4	R1/4	21.9	40.9	11.0	13	14.0×15.4	9.8	7.0	3.0	4.0	16.0
E45L6-M5	6	M5×0.8	22.4	38.6	4.0	15	12.0×13.0	12.6	2.0	2.0	3.5	10.0
E45L6-PT1/8	6	R1/8	22.4	41.1	8.0	15	12.0×13.0	12.6	5.0	5.0	12.0	12.0
E45L6-PT1/4	6	R1/4	23.6	45.1	11.0	15	14.0×15.4	12.6	7.0	5.0	12.0	18.0
E45L6-PT3/8	6	R3/8	25.2	46.1	12.0	15	17.0×18.5	12.6	9.0	5.0	12.0	26.0
E45L8-PT1/8	8	R1/8	25.5	44.0	8.0	16	14.0×15.4	14.6	5.0	5.0	18.5	15.0
E45L8-PT1/4	8	R1/4	25.5	48.0	11.0	16	14.0×15.4	14.6	7.0	7.0	23.0	20.0
E45L8-PT3/8	8	R3/8	27.0	49.0	12.0	16	17.0×18.5	14.6	9.0	7.0	23.0	28.0
E45L10-PT1/8	10	R1/8	30.0	50.0	8.0	19	17.0×18.5	17.5	5.0	5.0	22.0	22.0
E45L10-PT1/4	10	R1/4	30.0	54.0	11.0	19	17.0×18.5	17.5	7.0	7.0	34.5	27.0
E45L10-PT3/8	10	R3/8	30.0	55.0	12.0	19	17.0×18.5	17.5	9.0	9.0	37.0	33.0
E45L10-PT1/2	10	R1/2	33.0	59.0	15.0	19	22.0×24.5	17.5	12.0	9.0	38.5	52.0
E45L12-PT1/4	12	R1/4	33.5	58.7	11.0	20	19.0×21.0	20.0	7.0	7.0	43.0	34.0
E45L12-PT3/8	12	R3/8	33.5	59.7	12.0	20	19.0×21.0	20.0	9.0	9.0	47.0	40.0
E45L12-PT1/2	12	R1/2	35.3	63.7	15.0	20	22.0×24.5	20.0	12.0	10.0	47.0	57.0

Universal elbow

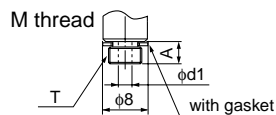
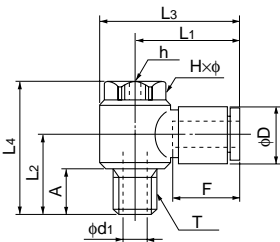

●Millimeter size type

Product number	Applicable tube outer diameter (mm)	T Thread size (M,R)	L1 (mm)	L2 (mm)	L3 (mm)	L4 (mm)	A (mm)	F Tube insertion length (mm)	H×φ Width across flat (mm)	h (mm)	D (mm)	d1 (mm)	Min. inner diameter (mm)	Effective cross-sectional area (mm ²)	Weight (g)
ELB4-M5	4	M5×0.8	20.4	11.5	25.3	21.0	4.0	13	8.0×9.0	3.0	9.8	2.0	2.0	3.0	10.0
ELB4-PT1/8	4	R1/8	23.4	17.5	30.4	30.0	9.5	13	13.0×14.0	5.0	9.8	5.0	3.0	4.0	20.0
ELB6-M5	6	M5×0.8	20.8	11.5	25.6	21.0	4.0	15	8.0×9.0	3.0	12.6	2.0	2.0	3.5	10.0
ELB6-PT1/8	6	R1/8	22.8	17.5	29.8	30.0	9.5	15	13.0×14.0	5.0	12.6	5.0	3.2	8.0	21.0
ELB6-PT1/4	6	R1/4	24.8	22.9	34.5	37.5	13.4	15	17.0×18.3	6.0	12.6	7.0	4.2	9.0	43.0
ELB8-PT1/8	8	R1/8	24.4	17.5	31.4	30.0	9.5	16	13.0×14.0	5.0	14.6	5.0	3.2	9.0	41.0
ELB8-PT1/4	8	R1/4	26.4	22.9	36.1	37.5	13.4	16	17.0×18.3	6.0	14.6	7.0	4.2	14.5	44.0
ELB8-PT3/8	8	R3/8	28.4	24.4	40.4	40.5	13.9	16	21.0×22.6	8.0	14.6	9.0	6.0	19.0	69.0
ELB10-PT1/4	10	R1/4	29.4	22.9	39.1	37.5	13.4	19	17.0×18.3	6.0	17.5	7.0	4.2	15.5	74.0
ELB10-PT3/8	10	R3/8	31.4	24.4	43.4	40.5	13.9	19	21.0×22.6	8.0	17.5	9.0	6.0	23.0	74.0
ELB12-PT3/8	12	R3/8	34.3	24.3	48.3	40.5	13.8	20	24.0×26.0	8.0	20.0	10.0	8.0	25.5	92.0
ELB12-PT1/2	12	R1/2	34.3	27.3	48.3	43.5	16.8	20	24.0×26.0	8.0	20.0	12.0	8.0	25.5	100.0

Tube

Clean tube

Processed tube

PushOne fitting

QuickSeal fitting

Clean fitting/ Chemifit

Bamboo-shoot fitting

Control switch/ Detachable series

Jig/Tool/ Accessory

Technical information

Reference

90 degree branch elbow

●Millimeter size type

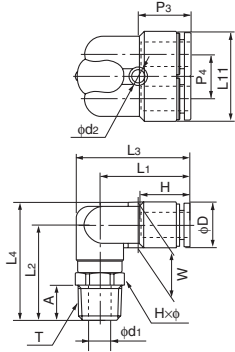

Product number	Applicable tube outer diameter (mm)	T Thread size (R)	L ₁ (mm)	L ₂ (mm)	L ₃ (mm)	L ₄ (mm)	L ₁₁ (mm)	A (mm)	F Tube insertion length (mm)	H×φ Width across flat (mm)	P ₃ (mm)	P ₄ (mm)	W (mm)	D (mm)	d ₁ (mm)	d ₂ (mm)	Effective cross-sectional area (mm ²)	Weight (g)
ELY6-PT1/8	6	R1/8	25.6	25.2	32.1	31.5	24.8	8.0	15	12.0×13.0	14.8	12.2	12.6	12.6	5.0	4.2	—	16.0
ELY6-PT1/4	6	R1/4	25.6	29.2	33.3	35.5	24.8	11.0	15	14.0×15.4	14.8	12.2	12.6	12.6	7.0	4.2	—	23.0
ELY8-PT1/8	8	R1/8	28.2	26.2	35.9	33.5	28.8	8.0	16	14.0×15.4	16.4	14.2	14.6	14.6	5.0	4.2	—	21.0
ELY8-PT1/4	8	R1/4	28.2	30.2	35.9	37.5	28.8	11.0	16	14.0×15.4	16.4	14.2	14.6	14.6	7.0	4.2	—	27.0
ELY8-PT3/8	8	R3/8	28.2	31.2	37.5	38.5	28.8	12.0	16	17.0×18.5	16.4	14.2	14.6	14.6	9.0	4.2	—	35.0
ELY10-PT1/4	10	R1/4	31.3	33.2	40.5	42.0	35.0	11.0	19	17.0×18.5	18.4	17.5	17.5	17.5	7.0	4.2	—	37.0
ELY10-PT3/8	10	R3/8	31.3	34.2	40.5	43.0	35.0	12.0	19	17.0×18.5	18.4	17.5	17.5	17.5	9.0	4.2	—	43.0

Universal branch elbow

●Millimeter size type

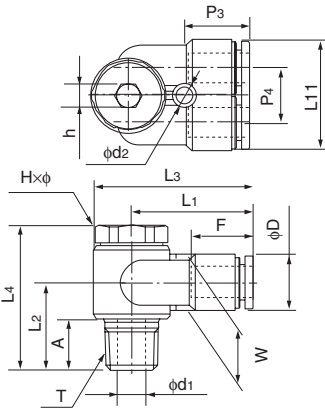

Product number	Applicable tube outer diameter (mm)	T Thread size (R)	L ₁ (mm)	L ₂ (mm)	L ₃ (mm)	L ₄ (mm)	L ₁₁ (mm)	A (mm)	F Tube insertion length (mm)	H×φ Width across flat (mm)	h Width across flat (mm)	P ₃ (mm)	P ₄ (mm)	W (mm)	D (mm)	d ₁ (mm)	d ₂ (mm)	Effective cross-sectional area (mm ²)	Weight (g)
ELYB6-PT1/8	6	R1/8	26.1	17.5	33.1	30.0	24.8	8.0	15	13.0×14.0	5.0	14.8	12.2	12.6	12.6	5.0	4.2	—	25.0
ELYB6-PT1/4	6	R1/4	29.0	22.9	38.7	37.5	24.8	11.0	15	17.0×18.3	6.0	14.8	12.2	12.6	12.6	7.0	4.2	—	46.0
ELYB8-PT1/4	8	R1/4	30.6	22.9	40.3	37.5	28.8	11.0	16	17.0×18.3	6.0	16.4	14.2	14.6	14.6	7.0	4.2	—	49.0
ELYB8-PT3/8	8	R3/8	32.9	22.5	40.5	40.5	28.8	12.0	16	21.0×22.6	8.0	16.4	14.2	14.6	14.6	9.0	4.2	—	58.0
ELYB10-PT1/4	10	R1/4	34.9	23.4	46.9	39.5	35.0	11.0	19	21.0×22.6	8.0	18.4	17.5	17.5	17.5	7.0	4.2	—	72.0
ELYB10-PT3/8	10	R3/8	34.9	24.4	46.9	40.5	35.0	12.0	19	21.0×22.6	8.0	18.4	17.5	17.5	17.5	9.0	4.2	—	80.0

Double universal elbow

●Millimeter size type

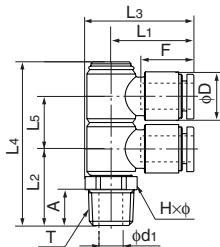

Product number	Applicable tube outer diameter (mm)	T Thread size (R)	L ₁ (mm)	L ₂ (mm)	L ₃ (mm)	L ₄ (mm)	L ₅ (mm)	A (mm)	F Tube insertion length (mm)	H×φ Width across flat (mm)	D (mm)	d ₁ (mm)	Effective cross-sectional area (mm ²)	Weight (g)
ELWB6-PT1/8	6	R1/8	22.8	18.8	30.5	42.3	13.5	8.0	15	14.0×15.4	12.6	5.0	—	33.0
ELWB6-PT1/4	6	R1/4	22.8	21.8	30.5	45.3	13.5	11.0	15	14.0×15.4	12.6	7.0	—	35.0
ELWB8-PT1/4	8	R1/4	24.4	23.0	32.1	50.0	16.0	11.0	16	14.0×15.4	14.6	7.0	—	39.0
ELWB8-PT3/8	8	R3/8	24.4	24.0	32.1	54.0	16.0	12.0	16	17.0×18.5	14.6	9.0	—	47.0
ELWB10-PT1/4	10	R1/4	29.4	24.5	39.1	56.0	19.0	11.0	19	17.0×18.5	17.5	7.0	—	72.0
ELWB10-PT3/8	10	R3/8	29.4	25.5	39.1	57.0	19.0	12.0	19	17.0×18.5	17.5	9.0	—	70.0

Tube

Clean tube

Processed tube

PushOne fitting

QuickSeal fitting

Clean fitting/ Chemifit

Bamboo-shoot fitting

Control switch/ Detachable series

Jig/Tool/ Accessory

Technical information

Reference

Triple universal elbow



●Millimeter size type

Product number	Applicable tube outer diameter (mm)	T Thread size (R)	L ₁ (mm)	L ₂ (mm)	L ₃ (mm)	L ₄ (mm)	L ₅ (mm)	A (mm)	F Tube insertion length (mm)	H×φ Width across flat (mm)	D (mm)	d ₁ (mm)	Effective cross-sectional area (mm ²)	Weight (g)
ELTB6-PT1/8	6	R1/8	22.8	18.8	30.5	55.5	13.5	8.0	15	14.0×15.4	12.6	5.0	—	43.0
ELTB6-PT1/4	6	R1/4	22.8	21.8	30.5	58.5	13.5	11.0	15	14.0×15.4	12.6	7.0	—	45.0
ELTB8-PT1/4	8	R1/4	24.4	23.0	32.1	66.0	16.0	11.0	16	14.0×15.4	14.6	7.0	—	51.0
ELTB8-PT3/8	8	R3/8	24.4	24.0	32.1	67.0	16.0	12.0	16	17.0×18.5	14.6	9.0	—	59.0
ELTB10-PT1/4	10	R1/4	29.4	24.5	39.1	75.5	19.0	11.0	19	17.0×18.5	17.5	7.0	—	98.0
ELTB10-PT3/8	10	R3/8	29.4	25.5	39.1	76.5	19.0	12.0	19	17.0×18.5	17.5	9.0	—	92.0

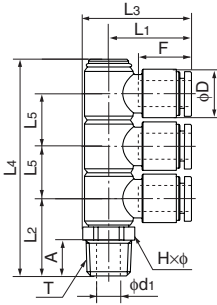

Tee



●Millimeter size type

Product number	Applicable tube outer diameter (mm)	T Thread size (M,R)	L ₁ (mm)	L ₂ (mm)	L ₄ (mm)	L ₅ (mm)	A (mm)	F Tube insertion length (mm)	H×φ Width across flat (mm)	D (mm)	d ₁ (mm)	Min. inner diameter (mm)	Effective cross-sectional area (mm ²)	Weight (g)
ET4-M5	4	M5×0.8	17.2	20.2	25.1	34.4	4.0	13	10.0×11.0	9.8	2.0	2.0	3.0	8.0
ET4-PT1/8	4	R1/8	17.2	22.7	27.6	34.4	8.0	13	10.0×11.0	9.8	5.0	3.0	4.0	10.0
ET4-PT1/4	4	R1/4	17.2	26.7	31.6	34.4	11.0	13	14.0×15.4	9.8	7.0	3.0	4.0	17.0
ET6-M5	6	M5×0.8	18.5	22.7	29.0	37.0	4.0	15	12.0×13.0	12.6	2.0	2.0	3.5	12.0
ET6-PT1/8	6	R1/8	18.5	25.2	31.5	37.0	8.0	15	12.0×13.0	12.6	5.0	5.0	12.0	14.0
ET6-PT1/4	6	R1/4	18.5	29.2	35.5	37.0	11.0	15	14.0×15.4	12.6	7.0	5.0	12.0	21.0
ET6-PT3/8	6	R3/8	18.5	30.2	36.5	37.0	12.0	15	17.0×18.5	12.6	9.0	5.0	12.0	29.0
ET8-PT1/8	8	R1/8	20.7	26.2	33.5	41.4	8.0	16	14.0×15.4	14.6	5.0	5.0	18.5	18.0
ET8-PT1/4	8	R1/4	20.7	30.2	37.5	41.4	11.0	16	14.0×15.4	14.6	7.0	7.0	23.0	24.0
ET8-PT3/8	8	R3/8	20.7	31.2	38.5	41.4	12.0	16	17.0×18.5	14.6	9.0	7.0	23.0	32.0
ET10-PT1/8	10	R1/8	24.7	29.2	38.0	49.3	8.0	19	17.0×18.5	17.5	5.0	5.0	22.0	28.0
ET10-PT1/4	10	R1/4	24.7	33.2	42.0	49.3	11.0	19	17.0×18.5	17.5	7.0	7.0	34.5	34.0
ET10-PT3/8	10	R3/8	24.7	34.2	43.0	49.3	12.0	19	17.0×18.5	17.5	9.0	9.0	37.0	39.0
ET10-PT1/2	10	R1/2	24.7	38.2	47.0	49.3	15.0	19	22.0×24.5	17.5	12.0	9.0	37.0	58.0
ET12-PT1/4	12	R1/4	26.3	35.7	45.7	52.6	11.0	20	19.0×21.0	20.0	7.0	7.0	36.0	43.0
ET12-PT3/8	12	R3/8	26.3	36.7	46.7	52.6	12.0	20	19.0×21.0	20.0	9.0	9.0	43.0	48.0
ET12-PT1/2	12	R1/2	26.3	40.7	50.7	52.6	15.0	20	22.0×24.5	20.0	12.0	10.0	43.0	65.0
ET16-PT3/8	16	R3/8	34.9	45.0	58.8	69.8	12.0	27	24.0×27.0	28.0	11.0	11.0	70.0	92.0
ET16-PT1/2	16	R1/2	34.9	48.0	61.8	69.8	15.0	27	24.0×27.0	28.0	12.0	12.0	93.0	106.0

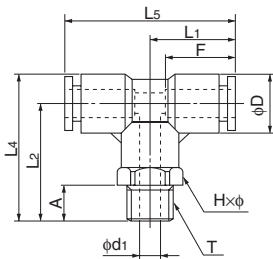

M thread

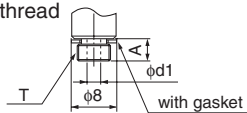

●Inch size type

Product number	Applicable tube outer diameter (inch)	T Thread size (M,R)	L ₁ (mm)	L ₂ (mm)	L ₄ (mm)	L ₅ (mm)	A (mm)	F Tube insertion length (mm)	H×φ Width across flat (mm)	D (mm)	d ₁ (mm)	Min. inner diameter (mm)	Effective cross-sectional area (mm ²)	Weight (g)
ET1/4-PT1/8	1/4	R1/8	18.1	25.2	31.5	36.2	8.0	15	12.0×13.0	13.0	5.0	4.6	13.0	14.0
ET1/4-PT1/4	1/4	R1/4	18.1	29.2	35.5	36.2	11.0	15	14.0×15.4	13.0	7.0	4.6	13.0	21.0
ET5/16-PT1/8	5/16	R1/8	20.6	26.2	33.5	41.2	8.0	16	14.0×15.4	15.0	5.0	5.0	18.5	18.0
ET5/16-PT1/4	5/16	R1/4	20.6	30.2	37.5	41.2	11.0	16	14.0×15.4	15.0	7.0	7.0	23.0	24.0
ET5/16-PT3/8	5/16	R3/8	24.4	31.2	38.5	48.8	12.0	19	17.0×18.5	18.0	9.0	7.0	—	—
ET3/8-PT1/4	3/8	R1/4	24.4	33.2	42.0	48.8	11.0	19	17.0×18.5	18.0	7.0	7.0	30.0	34.0
ET3/8-PT3/8	3/8	R3/8	24.4	34.2	43.0	48.8	12.0	19	17.0×18.5	18.0	9.0	9.0	32.0	39.0
ET3/8-PT1/2	3/8	R1/2	24.4	38.2	47.0	48.8	15.0	19	22.0×24.5	18.0	12.0	9.0	32.0	58.0
ET1/2-PT3/8	1/2	R3/8	26.5	36.7	47.2	52.9	12.0	21	19.0×21.0	21.5	9.0	9.0	53.0	48.0
ET1/2-PT1/2	1/2	R1/2	26.5	40.7	51.2	52.9	15.0	21	22.0×24.5	21.5	12.0	10.0	55.5	65.0

☞ The inch size type is not plated.

Service tee

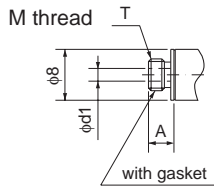
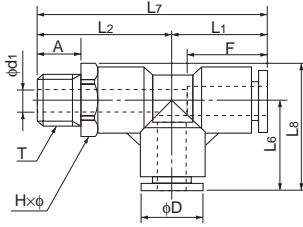

●Millimeter size type

Product number	Applicable tube outer diameter (mm)	T Thread size (M,R)	L ₁ (mm)	L ₂ (mm)	L ₃ (mm)	L ₄ (mm)	L ₅ (mm)	L ₆ (mm)	L ₇ (mm)	A (mm)	F Tube insertion length (mm)	H×φ Width across flat (mm)	D (mm)	d ₁ (mm)	Min. inner diameter (mm)	Effective cross-sectional area (mm ²)	Weight (g)
EST4-M5	4	M5×0.8	17.2	20.2	17.2	37.4	22.1	4.0	13	10.0×11.0	9.8	2.0	2.0	3.0	4.0	8.0	
EST4-PT1/8	4	R1/8	17.2	22.7	17.2	39.9	22.1	8.0	13	10.0×11.0	9.8	5.0	3.0	4.0	10.0		
EST4-PT1/4	4	R1/4	17.2	26.7	17.2	43.9	24.9	11.0	13	14.0×15.4	9.8	7.0	3.0	4.0	18.0		
EST6-M5	6	M5×0.8	18.5	22.7	18.5	41.2	25.0	4.0	15	12.0×13.0	12.6	2.0	2.0	3.5	12.0		
EST6-PT1/8	6	R1/8	18.5	25.2	18.5	43.7	25.0	8.0	15	12.0×13.0	12.6	5.0	5.0	12.0	14.0		
EST6-PT1/4	6	R1/4	18.5	29.2	18.5	47.7	26.2	11.0	15	14.0×15.4	12.6	7.0	5.0	12.0	21.0		
EST6-PT3/8	6	R3/8	18.5	30.2	18.5	48.7	27.8	12.0	15	17.0×18.5	12.6	9.0	5.0	12.0	29.0		
EST8-PT1/8	8	R1/8	20.7	26.2	20.7	46.9	28.4	8.0	16	14.0×15.4	14.6	5.0	5.0	18.5	18.0		
EST8-PT1/4	8	R1/4	20.7	30.2	20.7	50.9	28.4	11.0	16	14.0×15.4	14.6	7.0	7.0	23.0	24.0		
EST8-PT3/8	8	R3/8	20.7	31.2	20.7	51.9	30.0	12.0	16	17.0×18.5	14.6	9.0	7.0	23.0	32.0		
EST10-PT1/8	10	R1/8	24.7	29.2	24.7	53.9	33.9	8.0	19	17.0×18.5	17.5	5.0	5.0	22.0	28.0		
EST10-PT1/4	10	R1/4	24.7	33.2	24.7	57.9	33.9	11.0	19	17.0×18.5	17.5	7.0	7.0	34.5	34.0		
EST10-PT3/8	10	R3/8	24.7	34.2	24.7	58.9	33.9	12.0	19	17.0×18.5	17.5	9.0	9.0	37.0	40.0		
EST10-PT1/2	10	R1/2	24.7	38.2	24.7	62.9	36.9	15.0	19	22.0×24.5	17.5	12.0	9.0	37.0	58.0		
EST12-PT1/4	12	R1/4	26.3	35.7	26.3	62.0	36.8	11.0	20	19.0×21.0	20.0	7.0	7.0	36.0	43.0		
EST12-PT3/8	12	R3/8	26.3	36.7	26.3	63.0	36.8	12.0	20	19.0×21.0	20.0	9.0	9.0	43.0	48.0		
EST12-PT1/2	12	R1/2	26.3	40.7	26.3	67.0	38.6	15.0	20	22.0×24.5	20.0	12.0	10.0	43.0	65.0		
EST16-PT3/8	16	R3/8	34.9	45.0	34.9	79.9	48.7	12.0	27	24.0×27.0	28.0	11.0	11.0	70.0	92.0		
EST16-PT1/2	16	R1/2	34.9	48.0	34.9	82.9	48.7	15.0	27	24.0×27.0	28.0	12.0	12.0	93.0	106.0		

●Inch size type

Product number	Applicable tube outer diameter (inch)	T Thread size (R)	L ₁ (mm)	L ₂ (mm)	L ₃ (mm)	L ₄ (mm)	L ₅ (mm)	L ₆ (mm)	L ₇ (mm)	A (mm)	F Tube insertion length (mm)	H×φ Width across flat (mm)	D (mm)	d ₁ (mm)	Min. inner diameter (mm)	Effective cross-sectional area (mm ²)	Weight (g)
EST1/4-PT1/8	1/4	R1/8	18.1	25.2	18.1	43.3	24.6	8.0	15	12.0×13.0	13.0	5.0	5.0	13.0	14.0		
EST1/4-PT1/4	1/4	R1/4	18.1	29.2	18.1	47.3	25.8	11.0	15	14.0×15.4	13.0	7.0	5.0	13.0	21.0		
EST5/16-PT1/8	5/16	R1/8	20.6	26.2	20.6	46.8	28.3	8.0	16	14.0×15.4	15.0	5.0	5.0	18.5	18.0		
EST5/16-PT1/4	5/16	R1/4	20.6	30.2	20.6	50.8	28.3	11.0	16	14.0×15.4	15.0	7.0	7.0	23.0	24.0		
EST5/16-PT3/8	5/16	R3/8	24.4	31.2	24.4	51.9	29.9	12.0	19	17.0×18.5	18.0	9.0	7.0	—	—		
EST3/8-PT1/4	3/8	R1/4	24.4	33.2	24.4	57.6	33.7	11.0	19	17.0×18.5	18.0	7.0	7.0	30.0	34.0		
EST3/8-PT3/8	3/8	R3/8	24.4	34.2	24.4	58.6	33.7	12.0	19	17.0×18.5	18.0	9.0	9.0	32.0	40.0		
EST3/8-PT1/2	3/8	R1/2	24.4	38.2	24.4	62.6	36.4	15.0	19	22.0×24.0	18.0	12.0	9.0	32.0	58.0		
EST1/2-PT3/8	1/2	R3/8	27.5	36.7	27.5	64.2	38.0	12.0	21	19.0×21.0	21.5	9.0	9.0	53.0	48.0		
EST1/2-PT1/2	1/2	R1/2	27.5	40.7	27.5	68.2	39.5	15.0	21	22.0×24.0	21.5	12.0	10.0	55.5	65.0		

☞ The inch size type is not plated.

- Tube
- Clean tube
- Processed tube
- PushOne fitting
- QuickSeal fitting
- Clean fitting/Chemifit
- Bamboo-shoot fitting
- Control switch/Detachable series
- Jig/Tool/Accessory
- Technical information
- Reference

Y joint

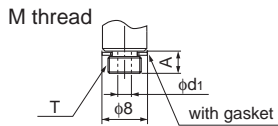
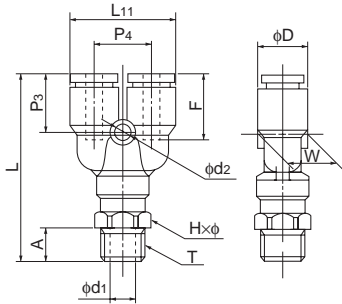

●Millimeter size type

Product number	Applicable tube outer diameter (mm)	T Thread size (M,R)	L (mm)	L ₁₁ (mm)	A (mm)	F Tube insertion length (mm)	H×φ Width across flat (mm)	P ₃ (mm)	P ₄ (mm)	W (mm)	D (mm)	d ₁ (mm)	d ₂ (mm)	Min. inner diameter (mm)	Effective cross-sectional area (mm ²)	Weight (g)
EY4-M5	4	M5×0.8	37.9	20.8	4.0	13	10.0×11.0	13.5	11.0	9.8	9.8	2.0	3.2	2.0	2.5	9.0
EY4-PT1/8	4	R1/8	40.4	20.8	8.0	13	10.0×11.0	13.5	11.0	9.8	9.8	5.0	3.2	3.0	3.5	11.0
EY4-PT1/4	4	R1/4	44.4	20.8	11.0	13	14.0×15.4	13.5	11.0	9.8	9.8	7.0	3.2	3.0	3.5	18.0
EY6-M5	6	M5×0.8	41.3	24.8	4.0	15	12.0×13.0	14.7	12.2	12.5	12.6	2.0	4.2	2.0	2.5	13.0
EY6-PT1/8	6	R1/8	43.8	24.8	8.0	15	12.0×13.0	14.7	12.2	12.5	12.6	5.0	4.2	5.0	9.0	15.0
EY6-PT1/4	6	R1/4	47.8	24.8	11.0	15	14.0×15.4	14.7	12.2	12.5	12.6	7.0	4.2	5.0	9.0	22.0
EY6-PT3/8	6	R3/8	48.8	24.8	12.0	15	17.0×18.5	14.7	12.2	12.5	12.6	9.0	4.2	5.0	9.0	30.0
EY8-PT1/8	8	R1/8	46.9	28.8	8.0	16	14.0×15.4	16.4	14.2	14.6	14.6	5.0	4.2	5.0	17.5	20.0
EY8-PT1/4	8	R1/4	50.9	28.8	11.0	16	14.0×15.4	16.4	14.2	14.6	14.6	7.0	4.2	7.0	20.0	25.0
EY8-PT3/8	8	R3/8	51.9	28.8	12.0	16	17.0×18.5	16.4	14.2	14.6	14.6	9.0	4.2	7.0	20.0	33.0
EY10-PT1/4	10	R1/4	55.9	35.0	11.0	19	17.0×18.5	18.4	17.5	17.5	17.5	7.0	4.2	7.0	27.5	33.0
EY10-PT3/8	10	R3/8	56.9	35.0	12.0	19	17.0×18.5	18.4	17.5	17.5	17.5	9.0	4.2	9.0	28.0	41.0
EY10-PT1/2	10	R1/2	60.9	35.0	15.0	19	22.0×24.5	18.4	17.5	17.5	17.5	12.0	4.2	9.0	28.0	60.0
EY12-PT1/4	12	R1/4	60.8	40.0	11.0	20	19.0×21.0	20.3	20.0	20.0	20.0	7.0	4.2	7.0	34.5	47.0
EY12-PT3/8	12	R3/8	61.8	40.0	12.0	20	19.0×21.0	20.3	20.0	20.0	20.0	9.0	4.2	9.0	40.0	52.0
EY12-PT1/2	12	R1/2	65.8	40.0	15.0	20	22.0×24.5	20.3	20.0	20.0	20.0	12.0	4.2	10.0	40.0	70.0
EY16-PT3/8	16	R3/8	78.6	55.0	12.0	27	24.0×27.0	26.6	27.5	27.5	28.0	11.0	4.2	11.0	70.0	103.0
EY16-PT1/2	16	R1/2	81.6	55.0	15.0	27	24.0×27.0	26.6	27.5	27.5	28.0	12.0	4.2	12.0	71.0	117.0

●Inch size type

Product number	Applicable tube outer diameter (inch)	T Thread size (R)	L (mm)	L ₁₁ (mm)	A (mm)	F Tube insertion length (mm)	H×φ Width across flat (mm)	P ₃ (mm)	P ₄ (mm)	W (mm)	D (mm)	d ₁ (mm)	d ₂ (mm)	Min. inner diameter (mm)	Effective cross-sectional area (mm ²)	Weight (g)
EY1/4-PT1/8	1/4	R1/8	43.4	24.7	8.0	15	12.0×13.0	14.4	12.2	12.5	13.0	5.0	4.2	5.0	10.5	15.0
EY1/4-PT1/4	1/4	R1/4	47.4	24.7	11.0	15	14.0×15.4	14.4	12.2	12.5	13.0	7.0	4.2	5.0	10.5	22.0
EY5/16-PT1/8	5/16	R1/8	46.8	28.7	8.0	16	14.0×15.4	16.3	14.2	14.5	15.0	5.0	4.2	5.0	17.5	20.0
EY5/16-PT1/4	5/16	R1/4	50.8	28.7	11.0	16	14.0×15.4	16.3	14.2	14.5	15.0	7.0	4.2	7.0	20.0	25.0
EY5/16-PT3/8	5/16	R3/8	51.9	35.0	12.0	19	17.0×18.5	18.1	17.5	17.5	18.0	9.0	4.2	7.0	—	—
EY3/8-PT1/4	3/8	R1/4	55.6	35.0	11.0	19	17.0×18.5	18.1	17.5	17.5	18.0	7.0	4.2	7.0	26.0	33.0
EY3/8-PT3/8	3/8	R3/8	56.6	35.0	12.0	19	17.0×18.5	18.1	17.5	17.5	18.0	9.0	4.2	9.0	26.0	41.0
EY1/2-PT1/4	1/2	R1/4	62.5	42.0	11.0	21	19.0×21.0	20.5	21.0	21.0	21.5	7.0	4.2	7.0	37.0	47.0
EY1/2-PT3/8	1/2	R3/8	63.5	42.0	12.0	21	19.0×21.0	20.5	21.0	21.0	21.5	9.0	4.2	9.0	48.0	52.0
EY1/2-PT1/2	1/2	R1/2	67.5	42.0	15.0	21	22.0×24.0	20.5	21.0	21.0	21.5	12.0	4.2	11.0	48.0	70.0

☞ The inch size type is not plated.

Union connector

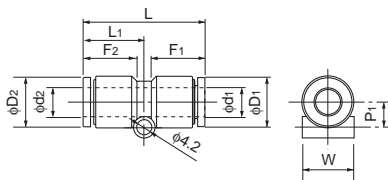

●Millimeter size type

Product number	d ₁ Applicable tube outer diameter (mm)	d ₂ Applicable tube outer diameter (mm)	L (mm)	L ₁ (mm)	P ₁ (mm)	F ₁ Tube insertion length (mm)	F ₂ Tube insertion length (mm)	D ₁ (mm)	D ₂ (mm)	W (mm)	Min. inner diameter (mm)	Effective cross-sectional area (mm ²)	Weight (g)
EUC4	4	4	31.8	15.9	5.0	13	13	9.8	9.8	9.7	4.0	3.5	4.0
EUC4-6	4	6	32.7	16.8	6.0	13	15	9.8	12.6	12.5	3.0	3.5	5.0
EUC6	6	6	33.6	16.8	6.0	15	15	12.6	12.6	12.5	6.0	12.5	6.0
EUC6-8	6	8	34.7	17.9	7.0	15	16	12.6	14.6	14.5	5.0	11.5	7.0
EUC8	8	8	35.8	17.9	7.0	16	16	14.6	14.6	14.5	8.0	28.0	8.0
EUC8-10	8	10	38.8	20.9	8.5	16	19	14.6	17.5	17.5	7.0	31.5	11.0
EUC10	10	10	41.7	20.9	8.5	19	19	17.5	17.5	17.5	14.0	45.0	14.0
EUC10-12	10	12	42.7	21.8	9.8	19	20	17.5	20.0	20.0	9.0	53.0	17.0
EUC12	12	12	43.6	21.8	9.8	20	27	20.0	20.0	20.0	19.0	67.0	19.0
EUC16	16	16	56.2	28.1	13.8	27	27	28.0	28.0	27.5	48.0	110.0	48.0

●Inch size type

Product number	d ₁ Applicable tube outer diameter (inch)	d ₂ Applicable tube outer diameter (inch)	L (mm)	L ₁ (mm)	P ₁ (mm)	F ₁ Tube insertion length (mm)	F ₂ Tube insertion length (mm)	D ₁ (mm)	D ₂ (mm)	W (mm)	Min. inner diameter (mm)	Effective cross-sectional area (mm ²)	Weight (g)
EUC1/4	1/4	1/4	32.8	16.4	6.0	15	15	13.0	13.0	12.5	5.0	12.5	6.0
EUC5/16	5/16	5/16	35.6	17.8	7.0	16	16	15.0	15.0	14.5	7.0	28.0	8.0
EUC3/8	3/8	3/8	41.2	20.6	8.5	19	19	18.0	18.0	17.5	9.0	35.0	14.0
EUC1/2	1/2	1/2	43.9	22.0	10.3	21	21	21.5	21.5	21.0	11.0	65.0	19.0

☞ The inch size type is not plated.

90 degree union elbow

●Millimeter size type



Product number	Applicable tube outer diameter (mm)	L ₁ (mm)	L ₈ (mm)	P ₁ (mm)	F Tube insertion length (mm)	D (mm)	W (mm)	Min. inner diameter (mm)	Effective cross-sectional area (mm ²)	Weight (g)
EUL4	4	17.2	22.1	6.9	13	9.8	9.7	3.0	3.5	4.0
EUL6	6	18.5	24.8	8.3	15	12.6	12.5	5.0	9.5	6.0
EUL8	8	20.7	28.0	9.3	16	14.6	14.5	7.0	19.5	9.0
EUL10	10	24.7	33.4	10.8	19	17.5	17.5	9.0	32.5	15.0
EUL12	12	26.3	36.3	12.1	20	20.0	20.0	11.0	45.5	20.0

Product number	Applicable tube outer diameter (mm)	L ₁ (mm)	L ₈ (mm)	L ₁₂ (mm)	P ₁ (mm)	F Tube insertion length (mm)	D (mm)	W (mm)	Min. inner diameter (mm)	Effective cross-sectional area (mm ²)	Weight (g)
EUL16	16	34.9	48.7	50.8	12.9	27	28.0	28.0	13.0	97.5	50.0
EULL16	16	34.9	48.7	61.5	12.9	27	28.0	27.5	13.0	96.5	56.0

*EUL16 and EULL16 have a different screw hole position.
*EULL16 is made to order.

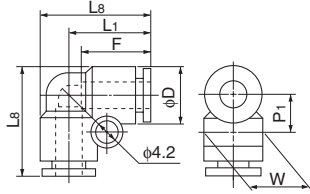

●Inch size type

Product number	Applicable tube outer diameter (inch)	L ₁ (mm)	L ₈ (mm)	P ₁ (mm)	F Tube insertion length (mm)	D (mm)	W (mm)	Min. inner diameter (mm)	Effective cross-sectional area (mm ²)	Weight (g)
EUL1/4	1/4	18.1	24.4	8.3	15	13.0	12.5	5.0	12.0	6.0
EUL5/16	5/16	20.6	27.9	9.3	16	15.0	14.5	7.0	20.0	9.0
EUL3/8	3/8	24.4	33.2	10.8	19	18.0	17.5	9.0	27.0	15.0
EUL1/2	1/2	27.5	38.0	12.6	21	21.5	21.0	11.0	54.5	20.0

☞ The inch size type is not plated.

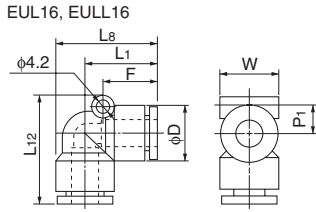

EUL16, EULL16

90 degree branch elbow

●Millimeter size type



Product number	Applicable tube outer diameter (mm)	L ₁ (mm)	L ₂ (mm)	L ₃ (mm)	L ₄ (mm)	L ₁₁ (mm)	F Tube insertion length (mm)	P ₃ (mm)	P ₄ (mm)	W (mm)	D (mm)	d ₂ (mm)	Min. inner diameter (mm)	Effective cross-sectional area (mm ²)	Weight (g)
EULY6	6	25.6	18.0	31.9	24.3	24.8	15	14.8	12.2	12.6	12.6	4.2	5.0	—	10.0
EULY8	8	28.2	19.6	35.5	26.9	28.8	16	16.4	14.2	14.6	14.6	4.2	7.0	—	14.0
EULY10	10	31.3	22.6	40.0	31.3	35.0	19	18.4	17.5	17.5	17.5	4.2	9.0	—	23.0

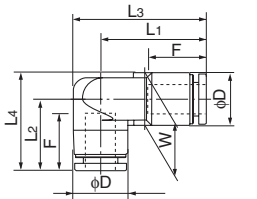
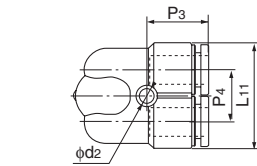
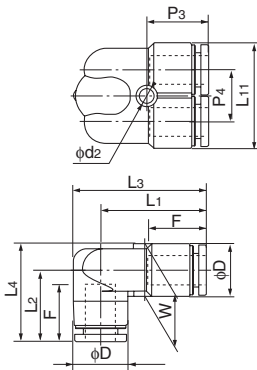

Union tee

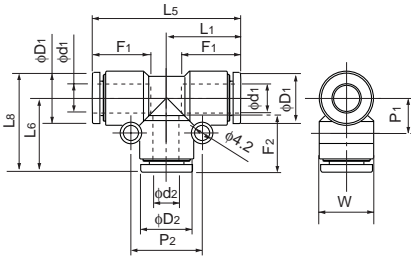

●Millimeter size type

Product number	d1 Applicable tube outer diameter (mm)	d2 Applicable tube outer diameter (mm)	L1 (mm)	L5 (mm)	L6 (mm)	L8 (mm)	F1 Tube insertion length (mm)	F2 Tube insertion length (mm)	P1 (mm)	P2 (mm)	D1 (mm)	D2 (mm)	W (mm)	Min. inner diameter (mm)	Effective cross- sectional area (mm ²)	Weight (g)
EUT4	4	4	17.2	34.4	17.2	22.1	13	13	6.9	14.0	9.8	9.8	9.7	3.0	3.5	6.0
EUT4-6	4	6	17.7	35.4	18.0	22.9	13	15	6.8	17.0	9.8	12.6	12.5	3.0	2.5	8.0
EUT6	6	6	18.5	37.0	18.5	24.8	15	15	8.3	17.0	12.6	12.6	12.5	5.0	4.5	9.0
EUT6-8	6	8	19.5	39.0	20.4	26.7	15	16	8.2	19.0	12.6	14.6	14.5	5.0	15.5	11.0
EUT8	8	8	20.7	41.4	20.7	28.0	16	16	9.3	19.0	14.6	14.6	14.5	7.0	19.5	13.0
EUT8-10	8	10	21.7	43.4	24.4	31.7	16	19	9.2	22.0	14.6	17.5	17.5	7.0	21.0	18.0
EUT10	10	10	24.7	49.3	24.7	33.4	19	19	10.8	22.0	17.5	17.5	17.5	9.0	32.5	22.0
EUT10-12	10	12	25.6	51.1	26.3	35.1	19	20	10.8	24.0	17.5	20.0	20.0	9.0	27.0	26.0
EUT12	12	12	26.3	52.6	26.3	36.3	20	20	12.1	24.0	20.0	20.0	20.0	11.0	45.5	29.0
EUT16	16	16	34.9	69.8	34.9	48.7	27	27	15.9	31.7	28.0	28.0	27.5	13.0	97.0	73.0

●Inch size type

Product number	d1 Applicable tube outer diameter (inch)	d2 Applicable tube outer diameter (inch)	L1 (mm)	L5 (mm)	L6 (mm)	L8 (mm)	F1 Tube insertion length (mm)	F2 Tube insertion length (mm)	P1 (mm)	P2 (mm)	D1 (mm)	D2 (mm)	W (mm)	Min. inner diameter (mm)	Effective cross- sectional area (mm ²)	Weight (g)
EUT1/4	1/4	1/4	18.1	36.2	18.1	24.4	15	15	8.3	17.0	13.0	13.0	12.5	5.0	12.0	9.0
EUT5/16	5/16	5/16	20.6	41.2	20.6	27.9	16	16	9.3	19.0	15.0	15.0	14.5	7.0	20.0	13.0
EUT3/8	3/8	3/8	24.4	48.8	24.4	33.2	19	19	10.8	22.0	18.0	18.0	17.5	9.0	27.0	22.0
EUT1/2	1/2	1/2	27.5	54.9	27.5	38.0	21	21	12.6	25.0	21.5	21.5	21.0	11.0	54.5	29.0

The inch size type is not plated.

Y union

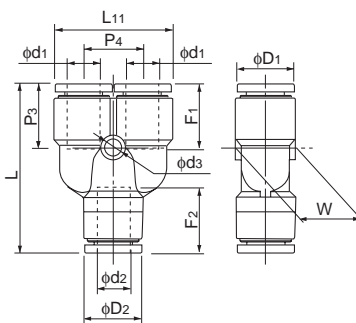

●Millimeter size type

Product number	d1 Applicable tube outer diameter (mm)	d2 Applicable tube outer diameter (mm)	L (mm)	L11 (mm)	F1 Tube insertion length (mm)	F2 Tube insertion length (mm)	P3 (mm)	P4 (mm)	W (mm)	D1 (mm)	D2 (mm)	d3 (mm)	Min. inner diameter (mm)	Effective cross- sectional area (mm ²)	Weight (g)
EYB4-4	4	4	33.8	20.8	13	13	13.5	11.0	9.8	9.8	9.8	3.2	3.0	3.0	6.0
EYB4-6	4	6	34.2	20.8	13	15	13.5	11.0	12.5	9.8	12.6	3.2	3.0	2.5	8.0
EYB6-6	6	6	37.5	24.8	15	15	14.7	12.2	12.5	12.6	12.6	4.2	5.0	8.0	10.0
EYB6-8	6	8	39.2	24.8	15	16	14.7	12.2	14.5	12.5	14.6	4.2	5.0	17.0	12.0
EYB8-8	8	8	42.9	28.8	16	16	16.4	14.2	14.6	14.6	14.6	4.2	7.0	18.0	14.0
EYB8-10	8	10	44.8	28.8	16	19	16.4	14.2	17.5	14.6	17.5	4.2	7.0	22.5	19.0
EYB10-10	10	10	48.3	35.0	19	19	18.4	17.5	17.5	17.5	17.5	4.2	9.0	27.0	24.0
EYB10-12	10	12	49.4	35.0	19	20	18.4	17.5	20.0	17.5	20.0	4.2	9.0	30.0	29.0
EYB12-12	12	12	54.0	40.0	20	20	20.3	20.0	20.0	20.0	20.0	4.2	11.0	38.5	33.0

●Inch size type

Product number	d1 Applicable tube outer diameter (inch)	d2 Applicable tube outer diameter (inch)	L (mm)	L11 (mm)	F1 Tube insertion length (mm)	F2 Tube insertion length (mm)	P3 (mm)	P4 (mm)	W (mm)	D1 (mm)	D2 (mm)	d3 (mm)	Min. inner diameter (mm)	Effective cross- sectional area (mm ²)	Weight (g)
EYB1/4	1/4	1/4	36.7	24.7	15	15	14.4	12.2	12.5	13.0	13.0	4.2	5.0	10.5	10.0
EYB5/16	5/16	5/16	42.7	28.7	16	16	16.3	14.2	14.5	15.0	15.0	4.2	7.0	19.5	14.0
EYB3/8	3/8	3/8	47.8	35.0	19	19	18.1	17.5	17.5	18.0	18.0	4.2	9.0	24.0	24.0
EYB1/2	1/2	1/2	55.8	42.0	21	21	20.5	21.0	21.0	21.5	21.5	4.2	11.0	46.5	33.0

The inch size type is not plated.

Double Y union

●Millimeter size type



Product number	d1 Applicable tube outer diameter (mm)	d2 Applicable tube outer diameter (mm)	L (mm)	L11 (mm)	F1 Tube insertion length (mm)	F2 Tube insertion length (mm)	P3 (mm)	P4 (mm)	W (mm)	D1 (mm)	D (mm)	ds (mm)	Min. inner diameter (mm)	Effective cross- sectional area (mm ²)	Weight (g)
EUWY4-6	4	6	34.2	19.8	13	15	13.4	10.0	19.8	9.8	12.6	3.2	3.5	—	10.0
EUWY6-8	6	8	39.2	24.8	15	16	14.8	12.2	24.8	12.6	14.6	4.2	5.0	—	16.0

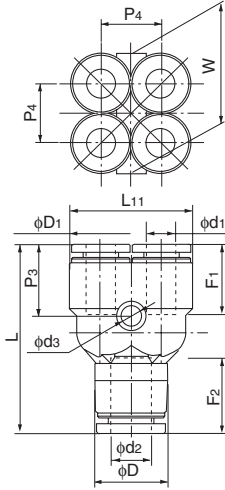

Panel touch connector

●Millimeter size type



Product number	Applicable tube outer diameter (mm)	L (mm)	F Tube insertion length (mm)	t Max. panel thickness (mm)	H4 (mm)	T1 Recommended panel hole diameter (mm)	Washer outer diameter (mm)	Washer thickness (mm)	Thread length (mm)	Min. inner diameter (mm)	Effective cross- sectional area (mm ²)	Weight (g)
EPC4	4	31.8	13	8.0	17.0	13	20	2.0	20	3.0	3.5	5.0
EPC6	6	33.6	15	9.5	19.0	15	24	2.5	22	5.0	12.5	7.0
EPC8	8	35.8	16	10.5	22.0	17	28	2.5	23	7.0	28.0	9.0
EPC10	10	41.7	19	14.0	27.0	21	34	3.0	27	9.0	45.0	16.0
EPC12	12	43.6	20	16.0	30.0	23	37	3.0	29	11.0	67.0	67.0

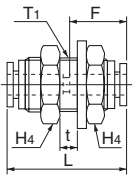

Internal panel touch connector

●Millimeter size type



Product number	Applicable tube outer diameter (mm)	T Thread size (Rc)	L (mm)	A (mm)	F Tube insertion length (mm)	H×φ Width across flat (mm)	H4 (mm)	t Max. panel thickness (mm)	T1 Recommended panel hole diameter (mm)	d1 (mm)	Washer outer diameter (mm)	Washer thickness (mm)	Min. inner diameter (mm)	Effective cross- sectional area (mm ²)	Weight (g)
EPFC4-PT1/8	4	Rc1/8	27.9	8.7	13	17.0×18.5	17.0	8.0	13	3.0	20	2.0	3.0	4.0	22.0
EPFC6-PT1/8	6	Rc1/8	29.8	8.7	15	19.0×21.0	19.0	9.0	15	5.0	24	2.5	5.0	10.5	44.0
EPFC6-PT1/4	6	Rc1/4	35.3	13.0	15	19.0×21.0	19.0	9.0	15	5.0	24	2.5	5.0	10.5	50.0
EPFC8-PT1/4	8	Rc1/4	34.4	13.0	16	22.0×24.5	22.0	10.5	17	7.0	28	2.5	7.0	25.0	64.0
EPFC8-PT3/8	8	Rc3/8	38.4	13.5	16	22.0×24.5	22.0	10.5	17	7.0	28	2.5	7.0	26.0	68.0
EPFC10-PT1/4	10	Rc1/4	40.4	13.0	19	27.0×30.0	27.0	14.0	21	9.0	34	3.0	9.0	40.0	117.0
EPFC10-PT3/8	10	Rc3/8	40.4	13.5	19	27.0×30.0	27.0	14.0	21	9.0	34	3.0	9.0	40.0	107.0
EPFC12-PT1/4	12	Rc1/4	42.3	13.0	20	30.0×33.5	30.0	16.0	23	10.5	37	3.0	10.5	45.0	147.0
EPFC12-PT3/8	12	Rc3/8	42.3	13.5	20	30.0×33.5	30.0	16.0	23	11.0	37	3.0	11.0	50.0	138.0

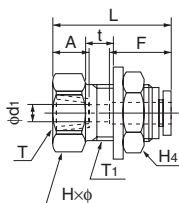

Tube

Clean tube

Processed tube

PushOne fitting

QuickSeal fitting

Clean fitting/ Chemifit

Bamboo-shoot fitting

Control switch/ Detachable series

Jig/Tool/ Accessory

Technical information

Reference

90 degree panel touch elbow

●Millimeter size type



Product number	Applicable tube outer diameter (mm)	L ₁ (mm)	L ₂ (mm)	L ₃ (mm)	L ₄ (mm)	F Tube insertion length (mm)	H× ϕ Width across flat (mm)	H ₄ Width across flat (mm)	t Max. panel thickness (mm)	T ₁ Recommended panel hole diameter (mm)	D (mm)	Washer outer diameter (mm)	Washer thickness (mm)	Min. inner diameter (mm)	Effective cross-sectional area (mm ²)	Weight (g)
EPL4	4	17.2	35.6	27.7	40.5	13	17.0×18.3	17.0	7.5	13	9.8	21	2.5	3.0	—	32.0
EPL6	6	18.5	40.0	30.5	46.3	15	19.0×21.0	19.0	9.0	15	12.6	24	2.5	5.0	—	43.0
EPL8	8	20.7	43.6	34.7	47.5	16	22.0×24.5	22.0	10.0	17	14.6	28	3.0	7.0	—	62.0
EPL10	10	24.7	51.6	41.7	60.3	19	27.0×30.0	27.0	14.0	21	17.5	34	3.0	9.0	—	101.0
EPL12	12	26.3	56.0	44.8	66.0	20	30.0×33.5	30.0	16.0	23	20.0	37	3.0	10.0	—	126.0

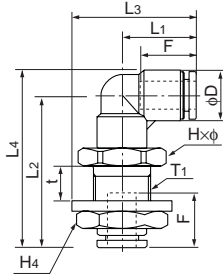

Reducer

●Millimeter size type



Product number	Applicable tube outer diameter (mm)	D ₁ Insertion part diameter (mm)	L (mm)	L ₁₀ (mm)	F Tube insertion length (mm)	D (mm)	Min. inner diameter (mm)	Effective cross-sectional area (mm ²)	Weight (g)
ER4-6	4	6	30.4	13.9	13	10.0	3.0	3.5	8.0
ER4-8	4	8	30.9	13.9	13	10.0	3.0	3.5	11.0
ER6-8	6	8	31.8	14.8	15	12.0	5.0	10.5	11.0
ER6-10	6	10	34.3	15.8	15	12.0	5.0	10.5	17.0
ER6-12	6	12	35.8	15.8	15	13.0	5.0	10.5	25.0
ER8-10	8	10	34.9	16.4	16	13.9	7.0	28.0	15.0
ER8-12	8	12	36.4	16.4	16	13.9	7.0	28.0	22.0
ER10-12	10	12	41.4	21.4	19	16.9	7.0	45.0	23.0

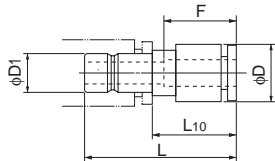

⚠ Caution: Once a reducer is inserted into a PushOne part, the part cannot be used to connect a tube.

Adopter elbow

●Millimeter size type



Product number	Applicable tube outer diameter (mm)	D ₁ Insertion part diameter (mm)	L ₁ (mm)	L ₂ (mm)	L ₃ (mm)	L ₄ (mm)	L ₁₀ (mm)	F Tube insertion length (mm)	D (mm)	Min. inner diameter (mm)	Effective cross-sectional area (mm ²)	Weight (g)
EAL4	4	4	17.2	30.7	22.1	35.6	14.7	13	9.8	3.0	4.0	6.0
EAL6	6	6	18.5	34.2	24.4	40.5	17.7	15	12.6	4.5	12.0	10.0
EAL8	8	8	20.7	35.7	27.6	43.0	18.7	16	14.6	6.0	20.0	14.0
EAL10	10	10	24.7	41.2	33.0	50.0	22.7	19	17.5	8.0	35.0	22.0
EAL12	12	12	26.3	45.2	35.7	55.2	25.2	20	20.0	10.0	43.0	30.0

⚠ Caution: Once an adaptor elbow is inserted into a PushOne part, the part cannot be used to connect a tube.

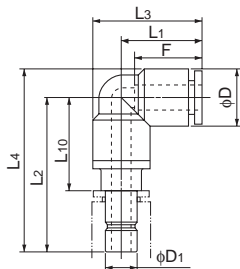

Y plug



●Millimeter size type

Product number	Applicable tube outer diameter (mm)	D ₁ Insertion part diameter (mm)	L (mm)	L ₁₀ (mm)	L ₁₁ (mm)	F Tube insertion length (mm)	P ₃ (mm)	P ₄ (mm)	W (mm)	D (mm)	d ₂ (mm)	Min. inner diameter (mm)	Effective cross-sectional area (mm ²)	Weight (g)
EYA4-4	4	4	48.4	32.4	20.8	13	13.5	11.0	9.8	9.8	3.2	3.0	3.5	8.0
EYA6-6	6	6	52.8	36.3	24.8	15	14.7	12.2	12.6	12.6	4.2	4.5	9.0	14.0
EYA8-8	8	8	56.4	39.4	28.8	16	16.4	14.2	14.6	14.6	4.2	6.0	18.0	19.0
EYA10-10	10	10	63.9	45.4	35.0	19	18.4	17.5	17.5	17.5	4.2	8.0	28.0	31.0
EYA12-12	12	12	70.3	50.3	40.0	20	20.3	20.0	20.0	20.0	4.2	10.0	40.0	42.0

⚠ Caution: Once a Y plug elbow is inserted into a PushOne part, the part cannot be used to connect a tube.

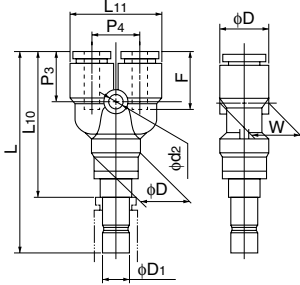

Manifold A type



●Millimeter size type

Product number	Applicable tube outer diameter (mm)		A Number of ports	L (mm)	L ₁ (mm)	L ₂ (mm)	L ₃ (mm)	L ₄ (mm)	L ₅ (mm)	L ₆ (mm)	L ₇ (mm)	L ₈ (mm)	F ₁ Tube insertion length (mm)	F ₂ Tube insertion length (mm)	P ₁ (mm)	d ₁ (mm)	d ₂ (mm)	Effective cross-sectional area (mm ²)	Weight (g)
	Port A	Port B																	
EMA4-8-6	4	8	6	61.0	30.5	36.0	10.0	18.2	27.5	18.2	9.3	18.5	13	16	10.6	9.7	14.5	—	20.0
EMA4-8-10	4	8	10	82.2	41.1	57.2	10.0	18.2	27.5	18.2	9.3	18.5	13	16	10.6	9.7	14.5	—	33.0
EMA6-10-6	6	10	6	73.7	36.9	44.0	11.5	20.2	29.5	20.2	9.3	18.5	15	19	13.0	12.5	17.5	—	37.0
EMA6-10-10	6	10	10	99.7	49.9	70.0	11.5	20.2	29.5	20.2	9.3	18.5	15	19	13.0	12.5	17.5	—	54.0
EMA8-12-6	8	12	6	83.2	41.6	51.0	12.5	22.1	32.6	22.1	10.5	21.0	16	20	15.5	14.5	20.0	—	50.0
EMA8-12-10	8	12	10	114.2	57.1	82.0	12.5	22.1	32.6	22.1	10.5	21.0	16	20	15.5	14.5	20.0	—	68.0

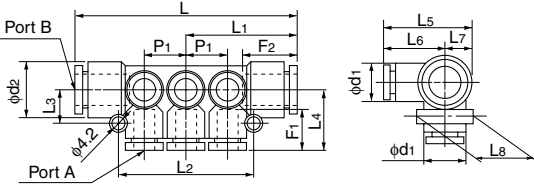

Manifold B type



●Millimeter size type

Product number	Applicable tube outer diameter (mm)		Thread size (Rc)	A Number of ports	L (mm)	L ₁ (mm)	L ₂ (mm)	L ₃ (mm)	L ₄ (mm)	L ₅ (mm)	L ₆ (mm)	L ₇ (mm)	L ₈ (mm)	F ₁ Tube insertion length (mm)	P ₁ (mm)	d ₁ (mm)	H x phi Width across flat (mm)	Effective cross-sectional area (mm ²)	Weight (g)
	Port A	Port B																	
EMB4-1/4-6	4	Rc1/4	6	84.0	42.0	36.0	10.0	18.2	27.5	18.2	9.3	18.5	13	10.6	9.7	17.0x18.5	—	58.0	
EMB4-1/4-10	4	Rc1/4	10	105.2	52.6	57.2	10.0	18.2	27.5	18.2	9.3	18.5	13	10.6	9.7	17.0x18.5	—	67.0	
EMB6-1/4-6	6	Rc1/4	6	96.4	48.2	44.0	11.5	20.2	29.5	20.2	9.3	18.5	15	13.0	12.5	17.0x18.5	—	79.0	
EMB6-1/4-10	6	Rc1/4	10	122.4	61.2	70.0	11.5	20.2	29.5	20.2	9.3	18.5	15	13.0	12.5	17.0x18.5	—	96.0	
EMB8-3/8-6	8	Rc3/8	6	105.6	52.8	51.0	12.5	22.1	32.6	22.1	10.5	21.0	16	15.5	14.5	19.0x21.0	—	92.0	
EMB8-3/8-10	8	Rc3/8	10	136.6	68.3	82.0	12.5	22.1	32.6	22.1	10.5	21.0	16	15.5	14.5	19.0x21.0	—	117.0	

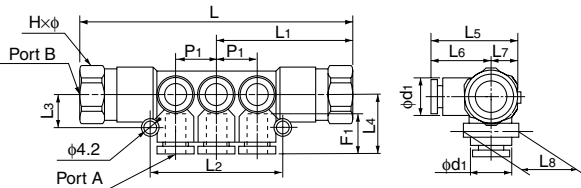

Tube
Clean tube
Processed tube
PushOne fitting
QuickSeal fitting
Clean fitting/Chemifit
Bamboo-shoot fitting
Control switch/Detachable series
Jig/Tool/Accessory
Technical information
Reference

Tube cap

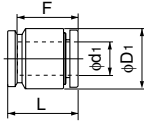

●Millimeter size type

Product number	d1 Applicable tube outer diameter (mm)	D1 (mm)	F Tube insertion length (mm)	L (mm)	Weight (g)
ECC4	4	9.8	13	15.0	2.0
ECC6	6	12.6	15	16.9	3.0
ECC8	8	14.6	16	17.9	4.0
ECC10	10	17.5	19	21.7	6.0
ECC12	12	20.0	20	22.6	8.0

Blank plug

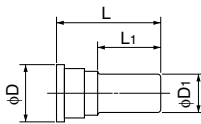

●Millimeter size type

Product number	D1 Insertion part diameter (mm)	L (mm)	L1 (mm)	D (mm)	Weight (g)
BC4	4	28.0	15.5	7.7	0.75
BC6	6	28.0	16.0	9.7	1.2
BC8	8	29.0	16.0	11.7	1.7
BC10	10	32.0	17.7	14.0	2.5
BC12	12	34.0	20.4	16.0	3.8

●Inch size type

Product number	D1 Insertion part diameter (inch)	L (mm)	L1 (mm)	D (mm)	Weight (g)
BC1/4	1/4	28.0	16.0	9.7	1.2
BC3/8	3/8	32.0	17.7	14.0	2.5
BC1/2	1/2	34.0	20.4	16.0	3.8

Size 5/16 is shared with BC8.

Nipple

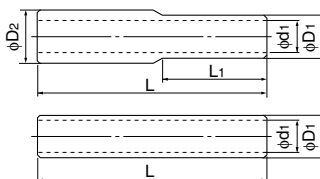

●Millimeter size type

Product number	D1 Insertion part diameter (mm)	D2 Insertion part diameter (mm)	d1 (mm)	L (mm)	L1 (mm)	Weight (g)
EN4	4	—	2.5	37.0	—	1.0
EN4-6	4	6	2.5	38.0	18.5	1.0
EN6	6	—	4.0	39.0	—	1.0
EN6-8	8	6	4.0	41.0	19.5	1.0
EN8	8	—	6.0	43.0	—	1.0
EN8-10	8	10	6.0	46.0	21.5	2.0
EN10	10	—	7.5	49.0	—	2.0
EN10-12	10	12	7.5	50.5	24.5	3.0
EN12	12	—	9.0	52.0	—	3.0

Tube

Clean tube

Processed tube

PushOne fitting

QuickSeal fitting

Clean fitting/Chemifit

Bamboo-shoot fitting

Control switch/Detachable series

Jig/Tool/Accessory

Technical information

Reference

PushOne® E Series Mini type

PushOne® fittings for general air pressure

Features

- PushOne® connection of tube
The tubes can be connected without using a jig or tools
- Electroless nickel plated
Preventing degradation of surface and dissolution of copper ions into fluid
- Compact body
Suitable for narrow piping or compact design equipment
- Sealing-processed R thread.
Sealing tape is not required.



Cross-sectional structure diagram

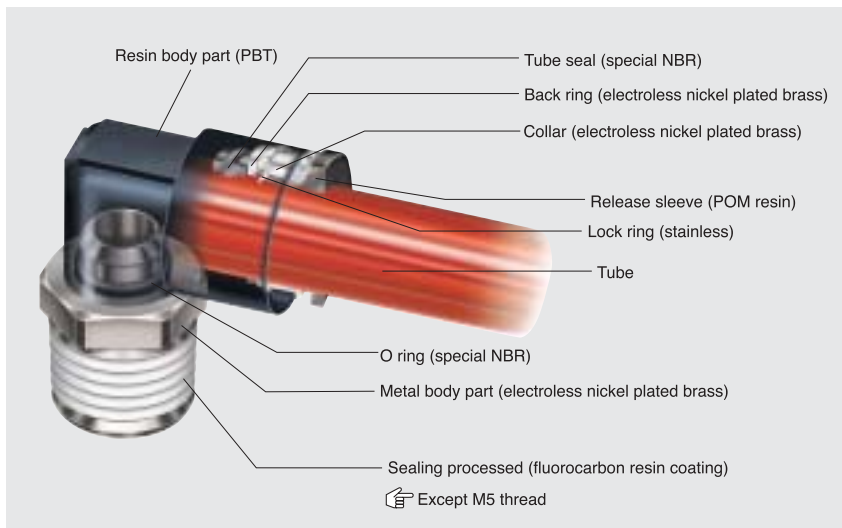

Operating fluid, working temperature range

Operating fluid	Working temperature range
Air	-20°C~+80°C

See "Combination List of Tube and Fitting" on page 8.

Pressure condition

Maximum working pressure: 1.0MPa
Negative pressure performance: -99.975kPa

Handling instructions

- ⚠ **Caution** When the working conditions of tubes and fittings differ, use them under the lower specified conditions.
 - ⚠ **Caution** Do not bend the pipe sharply near the tube insertion port of the fitting. Keep the tube straight for twice as long as the tube diameter from the insertion port.
- See page 34 for the common handling instructions for tube fittings.

Product number example

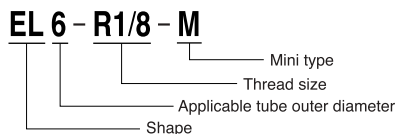

Size comparison of mini types



Applicable tube

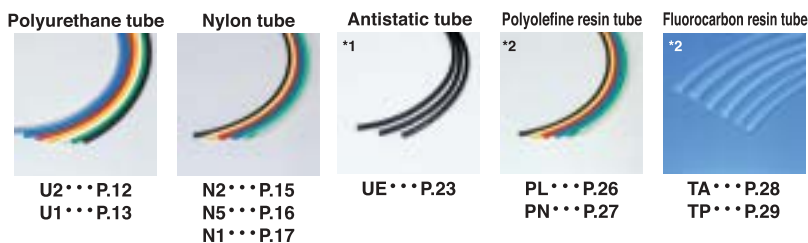

(*1) When the PushOne E series of the Mini type is used with a UE tube, choose a metal body type including a connector and a hexagonal socket to maintain conductivity between the tube and the fittings.
(*2) Combinatory use of PL, PN, TA or TP tube and PushOne E series of the Mini type mixes general and clean type performances. When using them in a clean environment, pay attention to the clean level that could be lowered.

Allied products and product introduction

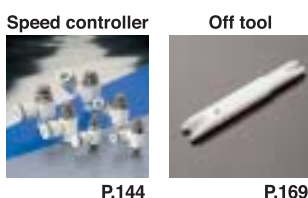

Reference

- Instruction manual.....P.178
- Effective cross-sectional area P.176
- Negative-pressure performance list.....P.177

Tube
Clean tube
Processed tube
PushOne fitting
QuickSeal fitting
Clean fitting/Chemifit
Bamboo-shoot fitting
Control switch/Detachable series
Jig/Tool/Accessory
Technical information
Reference

PushOne® E Series Mini type

Shape list



- Tube
- Clean tube
- Processed tube
- PushOne fitting**
- QuickSeal fitting
- Clean fitting/ Chemifit
- Bamboo-shoot fitting
- Control switch/ Detachable series
- Jig/Tool/ Accessory
- Technical information
- Reference

Connector

●Millimeter size type



Product number	Applicable tube outer diameter (mm)	T Thread size (M,R)	L (mm)	A (mm)	F Tube insertion length (mm)	H×φ Width across flat (mm)	d ₁ Min. inner diameter (mm)	Effective cross-sectional area (mm ²)	Weight (g)
EC3-M3-M	3	M3×0.5	13.0	3.0	9	5.5×6.0	1.5	2.0	2.0
EC3-M5-M	3	M5×0.8	14.0	3.5	9	7.0×7.7	2.0	2.5	3.2
EC4-M3-M	4	M3×0.5	14.2	3.0	10	8.0×8.8	1.5	2.0	4.0
EC4-M5-M	4	M5×0.8	14.2	3.5	10	8.0×8.8	2.5	3.5	4.0
EC4-R1/8-M	4	R1/8	14.0	7.3	10	10.0×11.0	2.5	4.0	5.4
EC6-M5-M	6	M5×0.8	15.2	3.5	11	10.0×11.0	2.5	4.5	3.6
EC6-R1/8-M	6	R1/8	16.7	7.3	11	10.0×11.0	4.0	9.0	5.6

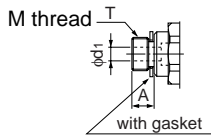
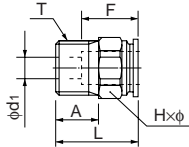

Hexagon socket connector

●Millimeter size type



Product number	Applicable tube outer diameter (mm)	T Thread size (M,R)	L (mm)	A (mm)	F Tube insertion length (mm)	h Width across flat (mm)	D (mm)	d ₁ Min. inner diameter (mm)	Effective cross-sectional area (mm ²)	Weight (g)
EC3-M3A-M	3	M3×0.5	13.0	3.0	9	1.5	5.5	1.5	2.0	2.0
EC3-M5A-M	3	M5×0.8	14.0	3.5	9	2.0	7.0	2.0	2.5	3.2
EC4-M3A-M	4	M3×0.5	14.0	3.0	10	1.5	7.8	1.5	2.0	4.0
EC4-M5A-M	4	M5×0.8	14.0	3.5	10	2.5	7.8	2.5	3.5	4.0
EC4-R1/8A-M	4	R1/8	13.8	7.3	10	2.5	10.0	2.5	4.0	5.4
EC6-M5A-M	6	M5×0.8	15.2	3.5	11	2.5	9.8	2.5	4.5	3.6
EC6-R1/8A-M	6	R1/8	16.7	7.3	11	4.0	10.0	4.0	9.0	5.6

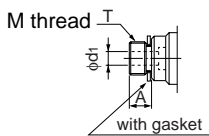
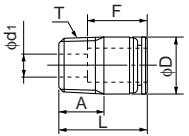

90 degree elbow

●Millimeter size type



Product number	Applicable tube outer diameter (mm)	T Thread size (M,R)	L ₁ (mm)	L ₂ (mm)	L ₃ (mm)	L ₄ (mm)	A (mm)	F Tube insertion length (mm)	H×φ Width across flat (mm)	D (mm)	d ₁ (mm)	Min. inner diameter (mm)	Effective cross-sectional area (mm ²)	Weight (g)
EL3-M3-M	3	M3×0.5	10.7	12.0	13.7	15.0	3.0	9	5.5×6.0	6.3	1.5	1.5	1.5	1.2
EL3-M5-M	3	M5×0.8	10.7	13.0	14.5	16.0	3.5	9	7.0×7.7	6.3	2.5	1.5	1.5	2.3
EL4-M3-M	4	M3×0.5	12.0	12.5	16.4	16.4	3.0	10	8.0×8.8	8.0	1.5	1.5	2.0	2.3
EL4-M5-M	4	M5×0.8	12.0	13.0	16.4	16.9	3.5	10	8.0×8.8	8.0	2.5	2.5	3.5	2.8
EL4-R1/8-M	4	R1/8	12.0	16.0	17.5	19.9	8.0	10	10.0×11.0	8.0	5.0	3.0	4.0	6.4
EL6-M5-M	6	M5×0.8	13.7	14.0	18.1	18.9	3.5	11	8.0×8.8	10.2	2.5	2.5	4.5	3.4
EL6-R1/8-M	6	R1/8	13.7	17.0	19.2	21.9	8.0	11	10.0×11.0	10.2	5.0	4.0	8.0	6.9

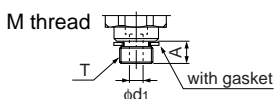
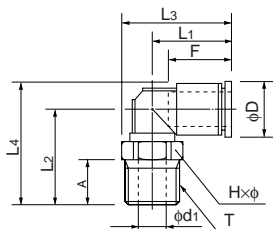

Tube
Clean tube
Processed tube
PushOne fitting
QuickSeal fitting
Clean fitting/Chemifit
Bamboo-shoot fitting
Control switch/Detachable series
Jig/Tool/Accessory
Technical information
Reference

90 degree long elbow

●Millimeter size type



Product number	Applicable tube outer diameter (mm)	T Thread size (M,R)	L1 (mm)	L2 (mm)	L3 (mm)	L4 (mm)	A (mm)	F Tube insertion length (mm)	H×φ Width across flat (mm)	D (mm)	d1 (mm)	Min. inner diameter (mm)	Effective cross-sectional area (mm ²)	Weight (g)
ELL3-M3-M	3	M3×0.5	10.7	20.0	13.7	23.0	3.0	9	5.5×6.0	6.3	1.5	1.5	1.5	9.7
ELL3-M5-M	3	M5×0.8	10.7	21.0	14.5	24.0	3.5	9	7.0×7.7	6.3	2.5	1.5	1.5	10.8
ELL4-M3-M	4	M3×0.5	12.0	24.5	16.4	28.4	3.0	10	8.0×8.8	8.0	1.5	1.5	2.0	10.8
ELL4-M5-M	4	M5×0.8	12.0	25.0	16.4	28.9	3.5	10	8.0×8.8	8.0	2.5	2.5	3.5	11.3
ELL4-R1/8-M	4	R1/8	12.0	28.0	17.5	31.9	8.0	10	10.0×11.0	8.0	5.0	3.0	4.0	14.9
ELL6-M5-M	6	M5×0.8	13.7	26.0	18.1	30.9	3.5	11	8.0×8.8	10.2	2.5	2.5	4.5	11.9
ELL6-R1/8-M	6	R1/8	13.7	29.0	19.2	33.9	8.0	11	10.0×11.0	10.2	5.0	4.0	8.0	15.4

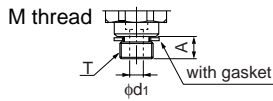
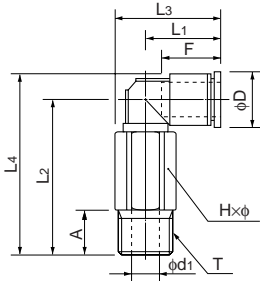

Tee

●Millimeter size type



Product number	Applicable tube outer diameter (mm)	T Thread size (M,R)	L1 (mm)	L2 (mm)	L4 (mm)	L5 (mm)	A (mm)	F Tube insertion length (mm)	H×φ Width across flat (mm)	D (mm)	d1 (mm)	Min. inner diameter (mm)	Effective cross-sectional area (mm ²)	Weight (g)
ET3-M3-M	3	M3×0.5	10.7	12.0	15.0	21.3	3.0	9	5.5×6.0	6.3	1.5	1.5	1.5	1.5
ET3-M5-M	3	M5×0.8	10.7	13.0	16.0	21.3	3.5	9	7.0×7.7	6.3	2.5	1.5	1.5	2.6
ET4-M3-M	4	M3×0.5	12.5	12.5	16.4	25.0	3.0	10	8.0×8.8	8.0	1.5	1.5	2.0	2.8
ET4-M5-M	4	M5×0.8	12.5	13.0	16.9	25.0	3.5	10	8.0×8.8	8.0	2.5	2.5	3.5	3.3
ET4-R1/8-M	4	R1/8	12.5	16.0	19.9	25.0	8.0	10	10.0×11.0	8.0	5.0	3.0	4.0	6.9
ET6-M5-M	6	M5×0.8	14.2	14.0	18.9	28.4	3.5	11	8.0×8.8	10.2	2.5	2.5	4.5	4.3
ET6-R1/8-M	6	R1/8	14.2	17.0	21.9	28.4	8.0	11	10.0×11.0	10.2	5.0	4.0	8.0	7.9

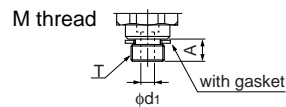
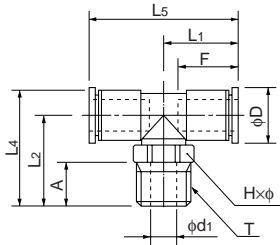

Service tee

●Millimeter size type



Product number	Applicable tube outer diameter (mm)	T Thread size (M,R)	L1 (mm)	L2 (mm)	L6 (mm)	L7 (mm)	L8 (mm)	A (mm)	F Tube insertion length (mm)	H×φ Width across flat (mm)	D (mm)	d1 (mm)	Min. inner diameter (mm)	Effective cross-sectional area (mm ²)	Weight (g)
EST3-M3-M	3	M3×0.5	10.7	12.0	10.7	22.7	13.7	3.0	9	5.5×6.0	6.3	1.5	1.5	1.5	1.5
EST3-M5-M	3	M5×0.8	10.7	13.0	10.7	23.7	14.6	3.5	9	7.0×7.7	6.3	2.5	1.5	1.5	2.6
EST4-M3-M	4	M3×0.5	12.5	12.5	12.5	25.0	16.9	3.0	10	8.0×8.8	8.0	1.5	1.5	2.0	2.8
EST4-M5-M	4	M5×0.8	12.5	13.0	12.5	25.5	16.9	3.5	10	8.0×8.8	8.0	2.5	2.5	3.5	3.3
EST4-R1/8-M	4	R1/8	12.5	16.0	12.5	28.5	18.0	8.0	10	10.0×11.0	8.0	5.0	3.0	4.0	6.9
EST6-M5-M	6	M5×0.8	14.2	14.0	14.2	28.2	19.1	3.5	11	8.0×8.8	10.2	2.5	2.5	4.5	4.4
EST6-R1/8-M	6	R1/8	14.2	17.0	14.2	31.2	19.7	8.0	11	10.0×11.0	10.2	5.0	4.0	8.0	7.9

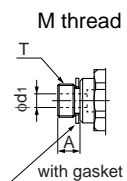
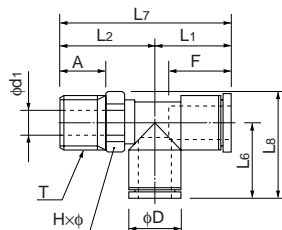

Y joint

●Millimeter size type



Product number	Applicable tube outer diameter (mm)	T Thread size (M,R)	L (mm)	L ₁ (mm)	A (mm)	F Tube insertion length (mm)	H×φ Width across flat (mm)	P ₃ (mm)	P ₄ (mm)	W (mm)	D (mm)	d ₁ (mm)	d ₂ (mm)	Min. inner diameter (mm)	Effective cross-sectional area (mm ²)	Weight (g)
EY4-M3-M	4	M3×0.5	24.2	16.7	3.0	10	8.0×8.8	9.0	9.0	8.0	8.0	1.5	3.2	1.5	1.5	3.0
EY4-M5-M	4	M5×0.8	24.7	16.7	3.5	10	8.0×8.8	9.0	9.0	8.0	8.0	2.5	3.2	2.5	2.5	4.5
EY4-R1/8-M	4	R1/8	27.7	16.7	8.0	10	10.0×11.0	9.0	9.0	8.0	8.0	5.0	3.2	3.0	2.5	8.2
EY6-M5-M	6	M5×0.8	26.7	20.7	3.5	11	8.0×8.8	10.2	11.0	10.0	10.2	2.5	3.2	2.5	4.0	4.7
EY6-R1/8-M	6	R1/8	29.7	20.7	8.0	11	10.0×11.0	10.2	11.0	10.0	10.2	5.0	3.2	4.0	5.0	8.2

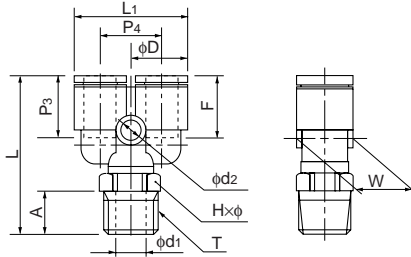

M thread

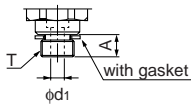

Union connector

●Millimeter size type



Product number	Applicable tube outer diameter (mm)	L ₁ (mm)	L ₂ (mm)	P ₁ (mm)	F Tube insertion length (mm)	D (mm)	W (mm)	Min. inner diameter (mm)	Effective cross-sectional area (mm ²)	Weight (g)
EUC3-M	3	19.4	9.7	3.6	9	6.3	6.0	2.0	2.5	0.7
EUC4-M	4	20.5	10.3	4.5	10	8.0	8.0	3.0	4.0	2.0
EUC6-M	6	22.9	11.5	5.4	11	10.2	10.0	4.0	8.5	2.2

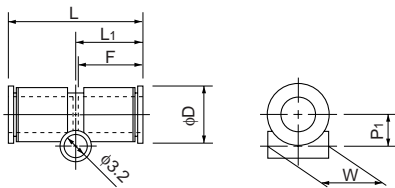

90 degree union elbow

●Millimeter size type



Product number	Applicable tube outer diameter (mm)	L ₁ (mm)	L ₂ (mm)	P ₁ (mm)	F Tube insertion length (mm)	D (mm)	W (mm)	Min. inner diameter (mm)	Effective cross-sectional area (mm ²)	Weight (g)
EUL3-M	3	10.7	13.7	4.1	9	6.3	6.0	2.0	2.0	0.8
EUL4-M	4	12.5	16.4	5.0	10	8.0	8.0	3.0	3.5	2.4
EUL6-M	6	14.2	19.1	6.5	11	10.2	10.0	4.0	8.0	2.4

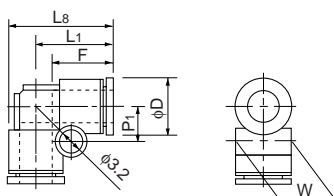

Tube

Clean tube

Processed tube

PushOne fitting

QuickSeal fitting

Clean fitting/ Chemifit

Bamboo-shoot fitting

Control switch/ Detachable series

Jig/Tool/ Accessory

Technical information

Reference

Union tee



●Millimeter size type

Product number	Applicable tube outer diameter (mm)	L ₁ (mm)	L ₅ (mm)	L ₆ (mm)	L ₈ (mm)	P ₁ (mm)	P ₂ (mm)	F Tube insertion length (mm)	D (mm)	W (mm)	Min. inner diameter (mm)	Effective cross-sectional area (mm ²)	Weight (g)
EUT3-M	3	10.7	21.4	10.7	13.7	4.1	8.2	9	6.3	6.0	2.0	2.0	1.2
EUT4-M	4	12.5	25.0	12.5	16.4	5.0	10.0	10	8.0	8.0	3.0	3.5	3.4
EUT6-M	6	14.2	28.4	14.2	19.1	6.5	13.0	11	10.2	10.0	4.0	8.0	3.5

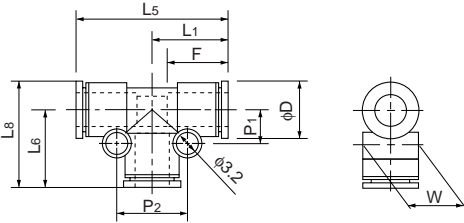

Y union



●Millimeter size type

Product number	Applicable tube outer diameter (mm)	L (mm)	L ₁₁ (mm)	F Tube insertion length (mm)	P ₃ (mm)	P ₄ (mm)	W (mm)	D (mm)	d ₂ (mm)	Min. inner diameter (mm)	Effective cross-sectional area (mm ²)	Weight (g)
EYB3-M	3	21.9	13.0	9	9.0	7.0	6.0	6.3	2.0	2.0	2.0	1.2
EYB4-M	4	24.0	16.7	10	9.0	9.0	8.0	8.0	3.2	3.0	2.0	3.4
EYB6-M	6	27.4	20.7	11	10.2	11.0	10.0	10.2	3.2	4.0	8.0	3.5

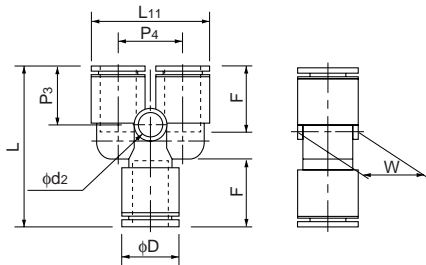

Blank plug



See the PushOne E series (P.65) for the product number and part sizes.

Nipple



See the PushOne E series (P.65) for the product number and part sizes.

PushOne® E Series Brass body type

PushOne® fittings for general air pressure

Features

- PushOne® connection of tube
The tubes can be connected without using a jig or tools
- Electrically conductive if combined with a UE tube
- Flame-resistant resin (compliant V-0 of UL94 standard)
Made of flame-resistant resin PBT. High self-extinguishing performance is compliant with V-0 of UL94 standard. Usable under an environment with spatters.
- Sealing-processed R thread.
Sealing tape is not required.
- The tube direction can be adjusted even after the thread is tightened in the types such as elbow, tee, etc.



Cross-sectional structure diagram

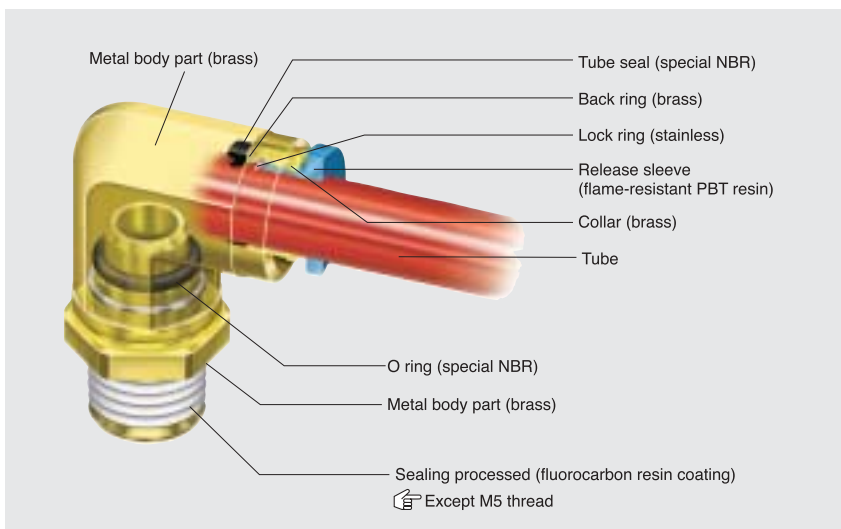

Operating fluid, working temperature range

Operating fluid	Working temperature range
Air	-20°C~+80°C

See "Combination List of Tube and Fitting" on page 8.

Pressure condition

Maximum working pressure: 1.0MPa
Negative pressure performance: -99.975kPa

Handling instructions





- ⚠ **Caution** When the working conditions of tubes and fittings differ, use them under the lower specified conditions.
 - ⚠ **Caution** Do not bend the pipe sharply near the tube insertion port of the fitting. Keep the tube straight for twice as long as the tube diameter from the insertion port.
- See page 34 for the common handling instructions for tube fittings.

Product number example

MEL 6 - PT1/8

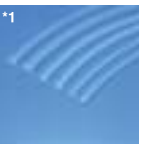

Applicable tube

Polyurethane tube	Nylon tube	Flame-resistant tube	Antistatic tube	Fluorocarbon resin tube
				
U2***P.12 U1***P.13 U5***P.14	N2***P.15 N5***P.16 N1***P.17	FS*****P.20 FW*****P.21 FWU***P.22	UE***P.23	TA***P.28 TP***P.29

(*1) Combinatory use of TA or TP tube and PushOne E series of the Brass body type mixes general and clean type performances. When using them in a clean environment, pay attention to the clean level that could be lowered.

Allied products and product introduction

Speed controller	Ball valve	Miniature valve	Valve built-in connector	Q.D.C 101 series	Spatter cap
					
P.144	P.151	P.156	P.159	P.160	P.169

Reference

- Instruction manual.....P.178
- UL-94 standard flame test.....P.204
- Effective cross-sectional area.....P.176
- Negative-pressure performance list.....P.177

Tube
Clean tube
Processed tube
PushOne fitting
QuickSeal fitting
Clean fitting/Chemifit
Bamboo-shoot fitting
Control switch/Detachable series
Jig/Tool/Accessory
Technical information
Reference

PushOne® E Series Brass body type

Shape list

90 degree elbow
MEL



P.74

Tee
MET



P.74

Service tee
MEST



P.74

Union connector
MEUC



P.75

90 degree union elbow
MEUL



P.75

Union tee
MEUT



P.75

Blank plug
BC



P.65

Nipple
EN



P.65

☞ Choose a connector from the PushOne A or E series.

Tube

Clean tube

Processed tube

PushOne fitting

QuickSeal fitting

Clean fitting/
Chemifit

Bambooshoot fitting

Control switch/
Detachable series

Jig/Tool/
Accessory

Technical information

Reference

PushOne® E Series Brass body type

90 degree elbow

●Millimeter size type

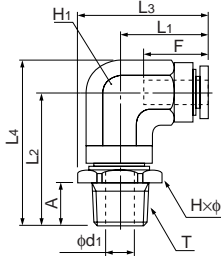

Product number	Applicable tube outer diameter (mm)	T Thread size (R)	L1 (mm)	L2 (mm)	L3 (mm)	L4 (mm)	A (mm)	F Tube insertion length (mm)	Hxφ Width across flat (mm)	H1 Width across flat (mm)	d1 (mm)	Min. inner diameter (mm)	Effective cross-sectional area (mm ²)	Weight (g)
MEL4-PT1/8	4	R1/8	16.3	26.0	22.8	31.8	8.0	13	12.0x13.0	10.0	5.0	3.0	4.0	22.0
MEL4-PT1/4	4	R1/4	16.3	29.0	24.0	34.8	11.0	13	14.0x15.4	10.0	7.0	3.0	4.0	28.0
MEL6-PT1/8	6	R1/8	18.7	27.0	26.4	33.9	8.0	15	14.0x15.4	12.0	5.0	5.0	12.0	31.0
MEL6-PT1/4	6	R1/4	18.7	30.0	26.4	36.9	11.0	15	14.0x15.4	12.0	7.0	5.0	12.0	35.0
MEL8-PT1/8	8	R1/8	20.2	27.5	29.5	35.6	8.0	16	17.0x18.5	14.0	5.0	5.0	18.5	41.0
MEL8-PT1/4	8	R1/4	20.2	30.5	29.5	38.6	11.0	16	17.0x18.5	14.0	7.0	7.0	23.0	45.0
MEL8-PT3/8	8	R3/8	20.2	31.5	29.5	39.6	12.0	16	17.0x18.5	14.0	9.0	7.0	23.0	53.0
MEL10-PT1/8	10	R1/8	24.6	29.0	35.1	39.4	8.0	19	19.0x21.0	18.0	5.0	5.0	22.0	65.0
MEL10-PT1/4	10	R1/4	24.6	32.0	35.1	42.4	11.0	19	19.0x21.0	18.0	7.0	7.0	34.5	70.0
MEL10-PT3/8	10	R3/8	24.6	33.0	35.1	43.4	12.0	19	19.0x21.0	18.0	9.0	9.0	37.0	75.0
MEL10-PT1/2	10	R1/2	24.6	37.0	36.6	47.4	15.0	19	22.0x24.0	18.0	12.0	9.0	37.0	92.0
MEL12-PT1/4	12	R1/4	26.6	32.0	37.1	42.4	11.0	20	19.0x21.0	18.0	7.0	7.0	36.0	69.0
MEL12-PT3/8	12	R3/8	26.6	33.0	37.1	43.4	12.0	20	19.0x21.0	18.0	9.0	9.0	43.0	75.0
MEL12-PT1/2	12	R1/2	26.6	37.0	38.6	47.4	15.0	20	22.0x24.0	18.0	12.0	9.0	43.0	92.0

Tee

●Millimeter size type

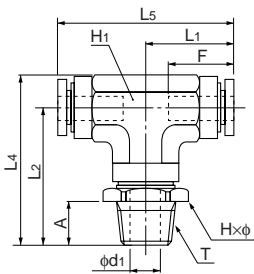

Product number	Applicable tube outer diameter (mm)	T Thread size (R)	L1 (mm)	L2 (mm)	L4 (mm)	L5 (mm)	A (mm)	F Tube insertion length (mm)	Hxφ Width across flat (mm)	H1 Width across flat (mm)	d1 (mm)	Min. inner diameter (mm)	Effective cross-sectional area (mm ²)	Weight (g)
MET6-PT1/8	6	R1/8	18.7	27.0	33.9	37.4	8.0	15	14.0x15.4	12.0	5.0	5.0	12.0	35.0
MET6-PT1/4	6	R1/4	18.7	30.0	36.9	37.4	11.0	15	14.0x15.4	12.0	7.0	5.0	12.0	39.0
MET8-PT1/8	8	R1/8	20.2	27.5	35.6	40.4	8.0	16	17.0x18.5	14.0	5.0	5.0	18.5	46.0
MET8-PT1/4	8	R1/4	20.2	30.5	38.6	40.4	11.0	16	17.0x18.5	14.0	7.0	7.0	23.0	50.0
MET10-PT1/8	10	R1/8	24.6	29.0	39.4	49.1	8.0	19	19.0x21.0	18.0	5.0	5.0	22.0	80.0
MET10-PT1/4	10	R1/4	24.6	32.0	42.4	49.1	11.0	19	19.0x21.0	18.0	7.0	7.0	34.5	84.0
MET10-PT3/8	10	R3/8	24.6	33.0	43.4	49.1	12.0	19	19.0x21.0	18.0	9.0	9.0	37.0	90.0
MET10-PT1/2	10	R1/2	24.6	37.0	47.4	49.1	15.0	19	22.0x24.0	18.0	12.0	9.0	37.0	106.0
MET12-PT1/4	12	R1/4	26.6	32.0	42.4	53.2	11.0	20	19.0x21.0	18.0	7.0	7.0	36.0	86.0
MET12-PT3/8	12	R3/8	26.6	33.0	43.4	53.2	12.0	20	19.0x21.0	18.0	9.0	9.0	43.0	92.0
MET12-PT1/2	12	R1/2	26.6	37.0	47.4	53.2	15.0	20	22.0x24.0	18.0	12.0	9.0	43.0	108.0

Service tee

●Millimeter size type

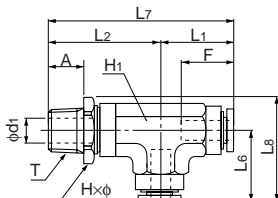

Product number	Applicable tube outer diameter (mm)	T Thread size (R)	L1 (mm)	L2 (mm)	L5 (mm)	L7 (mm)	L8 (mm)	A (mm)	F Tube insertion length (mm)	Hxφ Width across flat (mm)	H1 Width across flat (mm)	d1 (mm)	Min. inner diameter (mm)	Effective cross-sectional area (mm ²)	Weight (g)
MEST6-PT1/8	6	R1/8	18.7	28.1	18.7	46.8	26.4	8.0	15	14.0x15.4	12.0	5.0	5.0	12.0	37.0
MEST6-PT1/4	6	R1/4	18.7	31.1	18.7	49.8	26.4	11.0	15	14.0x15.4	12.0	7.0	5.0	12.0	41.0
MEST8-PT1/8	8	R1/8	20.2	29.1	20.2	49.3	29.5	8.0	16	17.0x18.5	14.0	5.0	5.0	18.5	50.0
MEST8-PT1/4	8	R1/4	20.2	32.1	20.2	52.3	29.5	11.0	16	17.0x18.5	14.0	7.0	7.0	23.0	54.0
MEST10-PT1/8	10	R1/8	24.6	30.1	24.6	54.7	35.1	8.0	19	19.0x21.0	18.0	5.0	5.0	22.0	82.0
MEST10-PT1/4	10	R1/4	24.6	33.1	24.6	57.7	35.1	11.0	19	19.0x21.0	18.0	7.0	7.0	34.5	86.0
MEST10-PT3/8	10	R3/8	24.6	34.1	24.6	58.7	35.1	12.0	19	19.0x21.0	18.0	9.0	9.0	37.0	92.0
MEST10-PT1/2	10	R1/2	24.6	38.1	24.6	62.7	36.6	15.0	19	22.0x24.0	18.0	12.0	9.0	37.0	108.0
MEST12-PT1/4	12	R1/4	26.6	34.1	26.6	60.7	37.1	11.0	20	19.0x21.0	18.0	7.0	7.0	36.0	90.0
MEST12-PT3/8	12	R3/8	26.6	35.1	26.6	61.7	37.1	12.0	20	19.0x21.0	18.0	9.0	9.0	43.0	95.0
MEST12-PT1/2	12	R1/2	26.6	39.1	26.6	65.7	38.6	15.0	20	22.0x24.0	18.0	12.0	9.0	43.0	112.0

Union connector

●Millimeter size type

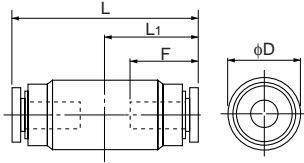

Product number	Applicable tube outer diameter (mm)	L (mm)	L ₁ (mm)	F Tube insertion length (mm)	D (mm)	Min. inner diameter (mm)	Effective cross-sectional area (mm ²)	Weight (g)
MEUC6	6	31.6	15.8	15	14.0	5.0	12.5	20.0
MEUC8	8	32.6	16.3	16	16.0	7.0	28.0	27.0
MEUC10	10	39.5	19.8	19	19.0	9.0	45.0	49.0
MEUC12	12	41.4	20.7	20	21.0	11.0	67.0	52.0

90 degree union elbow

●Millimeter size type

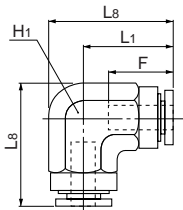

Product number	Applicable tube outer diameter (mm)	L ₁ (mm)	L ₈ (mm)	F Tube insertion length (mm)	H ₁ Width across flat (mm)	Min. inner diameter (mm)	Effective cross-sectional area (mm ²)	Weight (g)
MEUL6	6	18.7	25.6	15	12.0	5.0	9.5	20.0
MEUL8	8	20.2	28.3	16	14.0	7.0	19.5	29.0
MEUL10	10	24.6	34.9	19	18.0	9.0	32.5	63.0
MEUL12	12	26.6	37.0	20	18.0	11.0	45.5	56.0

Union tee

●Millimeter size type

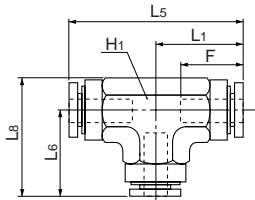

Product number	Applicable tube outer diameter (mm)	L ₁ (mm)	L ₅ (mm)	L ₆ (mm)	L ₈ (mm)	F Tube insertion length (mm)	H ₁ Width across flat (mm)	Min. inner diameter (mm)	Effective cross-sectional area (mm ²)	Weight (g)
MEUT6	6	18.7	37.4	18.7	25.6	15	12.0	5.0	9.5	25.0
MEUT8	8	20.2	40.4	20.2	28.3	16	14.0	7.0	19.5	35.0
MEUT10	10	24.6	49.1	24.6	34.9	19	18.0	9.0	32.5	70.0
MEUT12	12	26.6	53.2	26.6	37.0	20	18.0	11.0	45.5	73.0

Blank plug



See the PushOne E series (P65) for the product number and part sizes.

Nipple



See the PushOne E series (P65) for the product number and part sizes.

Insertion type (brass)

Screw-in type for multi-purpose piping

Features

- **Screw-in type**
Consisting of three parts: fitting body, nut and sleeve
- **High sealing performance**
The insertion part is integrated with a fitting body with high negative-pressure performance.
- **Only the connector is sealed.**
Sealing tape is not required.
- **JIS B 8381-1995 (fittings for pneumatic flexible pipes) compliant**



Cross-sectional structure diagram

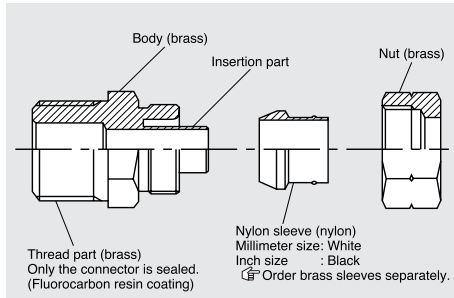

Sealing mechanism

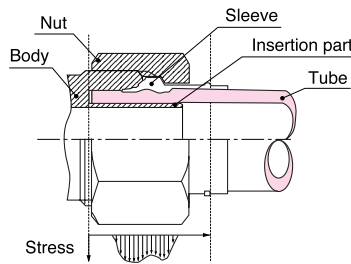

Operating fluid, working temperature range

Operating fluid	Working temperature range	
Air	Nylon sleeve	-40°C~+80°C
	Brass sleeve	-40°C~+100°C
Water	Nylon sleeve	0°C~+70°C
	Brass sleeve	0°C~+100°C
General operating oil	Nylon sleeve	-40°C~+80°C
	Brass sleeve	-40°C~+100°C

☞ Contact us for various chemical liquids.
☞ See "Combination List of Tube and Fitting" on page 8.

Pressure condition

Maximum working pressure: 5.0MPa
Negative pressure performance:
-101.294kPa

Handling instructions

- ⚠ **Caution** When the working conditions of tubes and fittings differ, use them under the lower specified conditions.
 - ⚠ **Caution** For use at a high temperature within the working temperature range, tighten nut periodically. If the nut cannot be tightened further, cut the tube end and insert the tube again with a new sleeve.
 - ⚠ **Caution** When water is used as the operating fluid, do not allow it to freeze.
 - ⚠ **Caution** Do not bend the pipe sharply near the tube insertion port (sleeve end) of the fitting. Keep the tube straight for twice as long as the tube diameter from the insertion port.
 - ⚠ **Caution** The brass sleeve cannot be used for a fluorocarbon resin TP tube. Choose the nylon sleeve instead.
 - ⚠ **Caution** The outer and the inner diameters of the fitting have to be the same as those of the tube used.
- ☞ See page 34 for the common handling instructions for tube fittings.

Product number example

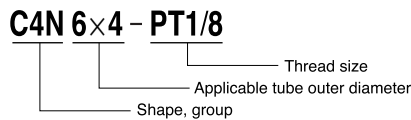









Distinction of millimeter/inch sizes

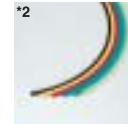
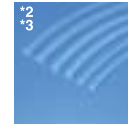

The inch size type has a black sleeve.
The millimeter size type has a cut at the hexagonal nut.

Applicable tube

Polyurethane tube	Nylon tube	Flexible fluorocarbon resin bilayer tube	Polybutene tube	Flame-resistant tube	Antistatic tube	Polyolefine resin tube	Fluorocarbon resin tube	Polyurethane processed tube
 U2***P.12 U1***P.13 U5***P.14	 N2***P.15 N5***P.16 N1***P.17	 TES***P.18	 PB***P.25	 FS***P.20 FW***P.21 FWU***P.22	 UE***P.23	 PL***P.26 PN***P.27	 TA***P.28 TP***P.29	 UC***P.30 USC***P.30 UMC***P.30 UML***P.31

(*1) When QuickSeal series fittings are used on a spatter-resistant line, replace the nylon sleeve with the brass one.
 (*2) Combinatory use of PL, PN, TA or TP tube and QuickSeal series of insertion type (brass) mixes general and clean type performances.
 When using them in a clean environment, pay attention to the clean level that could be lowered.
 (*3) The brass sleeve cannot be used for a fluorocarbon resin TP tube. Choose the nylon sleeve instead.

Allied products and product introduction

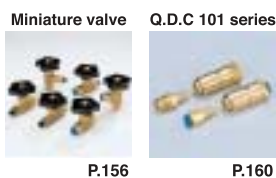

Reference

- Instruction manual.....P.180
- Chemical resistance specification table.....P.207
- Effective cross-sectional areaP.176
- Negative-pressure performance list.....P.177

QuickSeal Series Insertion type (brass)

Shape list



Inch size NPT type (Made to order)



Tube

Clean tube

Processed tube

PushOne fitting

QuickSeal fitting

Clean fitting/Chemifit

Bamboo-shoot fitting

Control switch/Detachable series

Jig/Tool/Accessory

Technical information

Reference

QuickSeal Series Insertion type (brass)

Connector

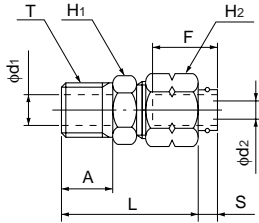

●Millimeter size type (Group 4)

Product number	Applicable tube outer diameter: inner diameter (mm)	T Thread size (R)	L (mm)	A (mm)	S (mm)	F Tube insertion length (mm)	H1 Width across flat (mm)	H2 Width across flat (mm)	d1 (mm)	d2 Min. inner diameter (mm)	Effective cross-sectional area (mm ²)	Weight (g)
C4N4×2-PT1/8	4×2	R1/8	28.0	11.0	4.7	15	10.0	10.0	5.0	0.9	0.7	13.0
C4N4×2-PT1/4	4×2	R1/4	30.0	12.0	4.7	15	14.0	10.0	7.0	0.9	0.7	20.0
C4N4×2.5-PT1/8	4×2.5	R1/8	28.0	11.0	4.7	15	10.0	10.0	5.0	1.3	1.5	13.0
C4N4×3-PT1/8	4×3	R1/8	28.0	11.0	4.7	15	10.0	10.0	5.0	2.0	3.0	13.0
C4N6×4-PT1/8	6×4	R1/8	28.0	11.0	4.6	15	10.0	12.0	5.0	2.7	5.0	15.0
C4N6×4-PT1/4	6×4	R1/4	30.0	12.0	4.6	15	14.0	12.0	7.0	2.7	5.0	22.0
C4N6×4-PT3/8	6×4	R3/8	31.0	13.0	4.6	15	17.0	12.0	9.0	2.7	5.5	32.0
C4N6×4.5-PT1/8	6×4.5	R1/8	28.0	11.0	4.6	15	10.0	12.0	5.0	3.2	7.5	15.0
C4N6×4.5-PT1/4	6×4.5	R1/4	30.0	12.0	4.6	15	14.0	12.0	7.0	3.2	7.5	23.0
C4N6×4.5-PT3/8	6×4.5	R3/8	31.0	13.0	4.6	15	17.0	12.0	9.0	3.2	7.5	32.0
C4N8×5-PT1/8	8×5	R1/8	27.9	11.0	4.6	16	12.0	14.0	5.0	3.7	10.0	18.0
C4N8×5-PT1/4	8×5	R1/4	29.9	12.0	4.6	16	14.0	14.0	7.0	3.7	10.0	24.0
C4N8×6-PT1/8	8×6	R1/8	27.9	11.0	4.6	16	12.0	14.0	5.0	4.7	16.0	17.0
C4N8×6-PT1/4	8×6	R1/4	29.9	12.0	4.6	16	14.0	14.0	7.0	4.7	16.0	24.0
C4N8×6-PT3/8	8×6	R3/8	30.9	13.0	4.6	16	17.0	14.0	9.0	4.7	17.0	33.0
C4N10×6.5-PT1/4	10×6.5	R1/4	31.1	12.0	4.2	17	17.0	17.0	7.0	5.2	20.5	32.0
C4N10×6.5-PT3/8	10×6.5	R3/8	32.1	13.0	4.2	17	17.0	17.0	9.0	5.2	20.5	38.0
C4N10×7.5-PT1/4	10×7.5	R1/4	31.1	12.0	4.2	17	17.0	17.0	7.0	6.2	30.0	32.0
C4N10×7.5-PT3/8	10×7.5	R3/8	32.1	13.0	4.2	17	17.0	17.0	9.0	6.2	30.0	37.0
C4N10×7.5-PT1/2	10×7.5	R1/2	40.1	18.0	4.2	17	22.0	17.0	12.0	6.2	30.0	68.5
C4N10×8-PT1/4	10×8	R1/4	31.1	12.0	4.2	17	15.0	17.0	7.0	6.7	32.0	29.0
C4N10×8-PT3/8	10×8	R3/8	32.1	13.0	4.2	17	17.0	17.0	9.0	6.7	32.0	37.0
C4N10×8-PT1/2	10×8	R1/2	40.1	18.0	4.2	17	22.0	17.0	12.0	6.7	33.5	80.0
C4N12×8-PT3/8	12×8	R3/8	35.6	13.0	4.8	18	17.0	19.0	9.0	6.6	32.0	47.0
C4N12×8-PT1/2	12×8	R1/2	40.6	18.0	4.8	18	23.0	19.0	12.0	6.6	33.5	75.0
C4N12×9-PT1/4	12×9	R1/4	31.6	12.0	4.8	18	17.0	19.0	7.6	7.6	40.0	34.0
C4N12×9-PT3/8	12×9	R3/8	35.6	13.0	4.8	18	17.0	19.0	9.0	7.6	40.0	40.5
C4N12×9-PT1/2	12×9	R1/2	40.6	18.0	4.8	18	23.0	19.0	12.0	7.6	40.0	74.0
C4N16×13-PT1/2	16×13	R1/2	46.7	18.0	5.1	23	24.0	27.0	12.0	11.0	90.0	108.0

*Made to order

☞ Only the connector is sealed.

●Inch size type (Group 1)

Product number	Applicable tube outer diameter (inch)	T Thread size (R)	L (mm)	A (mm)	S (mm)	F Tube insertion length (mm)	H1 Width across flat (mm)	H2 Width across flat (mm)	d1 (mm)	d2 Min. inner diameter (mm)	Effective cross-sectional area (mm ²)	Weight (g)
C1N1/8-PT1/8	1/8	R1/8	28.0	11.0	4.6	15	10.0	8.0	5.0	1.4	1.5	11.0
C1N3/16-PT1/8	3/16	R1/8	28.1	11.0	4.6	15	10.0	10.0	5.0	2.4	4.0	13.0
C1N3/16-PT1/4	3/16	R1/4	30.1	12.0	4.6	15	14.0	10.0	7.0	2.4	4.0	20.0
C1N1/4-PT1/8	1/4	R1/8	28.0	11.0	4.6	15	10.0	12.0	5.0	3.4	8.5	14.0
C1N1/4-PT1/4	1/4	R1/4	30.0	12.0	4.6	15	14.0	12.0	7.0	3.4	8.5	22.0
C1N1/4-PT3/8	1/4	R3/8	31.0	13.0	4.6	15	17.0	12.0	9.0	3.4	8.5	31.0
C1N5/16-PT1/8	5/16	R1/8	27.8	11.0	4.6	16	12.0	14.0	5.0	4.7	16.0	17.0
C1N5/16-PT1/4	5/16	R1/4	29.8	12.0	4.6	16	14.0	14.0	7.0	4.7	16.0	24.0
C1N5/16-PT3/8	5/16	R3/8	30.8	13.0	4.6	16	17.0	14.0	9.0	4.7	17.0	33.0
C1N3/8-PT1/8	3/8	R1/8	28.7	11.0	4.6	17	14.0	17.0	5.7	5.7	22.5	23.0
C1N3/8-PT1/4	3/8	R1/4	30.7	12.0	4.6	17	14.0	17.0	7.5	5.7	22.5	28.0
C1N3/8-PT3/8	3/8	R3/8	31.7	13.0	4.6	17	17.0	17.0	9.0	5.7	22.5	39.0
C1N3/8-PT1/2	3/8	R1/2	39.7	18.0	4.6	17	23.0	17.0	12.0	5.7	24.5	68.0
C1N1/2-PT1/4	1/2	R1/4	31.8	12.0	4.6	18	17.0	19.0	8.2	8.2	45.0	33.0
C1N1/2-PT3/8	1/2	R3/8	32.8	13.0	4.6	18	17.0	19.0	9.0	8.2	45.0	40.0
C1N1/2-PT1/2	1/2	R1/2	40.8	18.0	4.6	18	23.0	19.0	12.0	8.2	45.0	72.0
C1N5/8-PT3/8	5/8	R3/8	41.7	13.0	5.1	23	23.0	27.0	9.3	9.3	62.0	85.0
C1N5/8-PT1/2	5/8	R1/2	46.7	18.0	5.1	23	23.0	27.0	12.0	9.3	62.0	100.0

●Inch size type (Group 2)

Product number	Applicable tube outer diameter (inch)	T Thread size (R)	L (mm)	A (mm)	S (mm)	F Tube insertion length (mm)	H1 Width across flat (mm)	H2 Width across flat (mm)	d1 (mm)	d2 Min. inner diameter (mm)	Effective cross-sectional area (mm ²)	Weight (g)
C2N1/8-PT1/8	1/8	R1/8	28.0	11.0	4.6	21	10.0	8.0	5.0	3.0	1.0	11.0
C2N3/16-PT1/8	3/16	R1/8	28.1	11.0	4.6	15	10.0	10.0	5.0	1.4	1.5	12.0
C2N3/16-PT1/4	3/16	R1/4	30.1	12.0	4.6	15	14.0	10.0	7.0	1.4	1.5	20.0
C2N1/4-PT1/8	1/4	R1/8	28.0	11.0	4.6	15	10.0	12.0	5.0	2.2	3.5	14.5
C2N1/4-PT1/4	1/4	R1/4	30.0	12.0	4.6	15	14.0	12.0	7.0	2.2	3.5	22.0
C2N5/16-PT1/8	5/16	R1/8	27.8	11.0	4.6	16	12.0	14.0	5.0	2.9	6.0	18.0
C2N5/16-PT1/4	5/16	R1/4	29.8	12.0	4.6	16	14.0	14.0	7.0	2.9	6.0	24.0
C2N3/8-PT1/8	3/8	R1/8	28.7	11.0	4.6	17	14.0	17.0	5.0	3.5	8.0	24.0
C2N3/8-PT1/4	3/8	R1/4	30.7	12.0	4.6	17	14.0	17.0	7.0	3.5	8.0	29.0
C2N3/8-PT3/8	3/8	R3/8	31.7	13.0	4.6	17	17.0	17.0	9.0	3.5	8.0	38.0
C2N1/2-PT1/4	1/2	R1/4	31.8	12.0	4.6	18	17.0	19.0	7.0	5.2	20.5	35.0
C2N1/2-PT3/8	1/2	R3/8	32.8	13.0	4.6	18	17.0	19.0	9.0	5.2	20.5	40.0
C2N1/2-PT1/2	1/2	R1/2	40.8	18.0	4.6	18	23.0	19.0	12.0	5.2	20.5	74.0

☆C2N1/8-PT1/8 is of insertless type.

90 degree elbow

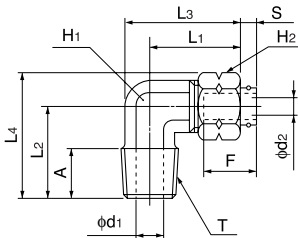

● Millimeter size type (Group 4)

Product number	Applicable tube outer diameter-inner diameter (mm)	T Thread size (R)	L1 (mm)	L2 (mm)	L3 (mm)	L4 (mm)	A (mm)	S (mm)	F Tube insertion length (mm)	H1 Width across flat (mm)	H2 Width across flat (mm)	d1 (mm)	d2 Min. inner diameter (mm)	Effective cross-sectional area (mm ²)	Weight (g)
L4N4x2-PT1/8	4x2	R1/8	20.5	18.5	26.2	24.3	11.0	4.7	15	10.0	10.0	5.0	0.9	0.5	19.0
L4N4x2-PT1/4	4x2	R1/4	20.5	22.0	27.4	28.9	12.0	4.7	15	12.0	10.0	7.0	0.9	0.5	28.0
L4N4x2.5-PT1/8	4x2.5	R1/8	20.5	18.5	26.2	24.3	11.0	4.7	15	10.0	10.0	5.0	1.3	1.5	19.0
L4N4x3-PT1/8	4x3	R1/8	20.5	18.5	26.2	24.3	11.0	4.7	15	10.0	10.0	5.0	2.0	2.5	19.0
L4N6x4-PT1/8	6x4	R1/8	20.5	18.5	26.3	25.4	11.0	4.6	15	10.0	12.0	5.0	2.7	4.5	21.0
L4N6x4-PT1/4	6x4	R1/4	23.0	22.0	29.9	28.9	12.0	4.6	15	12.0	12.0	7.0	2.7	4.5	32.0
L4N6x4.5-PT1/8	6x4.5	R1/8	20.5	18.5	26.3	25.4	11.0	4.6	15	10.0	12.0	5.0	3.2	7.0	21.0
L4N6x4.5-PT1/4	6x4.5	R1/4	23.0	22.0	29.9	28.9	12.0	4.6	15	12.0	12.0	7.0	3.2	7.0	32.0
L4N8x5-PT1/8	8x5	R1/8	22.9	21.0	29.8	29.1	11.0	4.6	16	12.0	14.0	5.0	3.7	9.0	31.0
L4N8x5-PT1/4	8x5	R1/4	22.9	22.0	29.8	30.1	12.0	4.6	16	12.0	14.0	7.0	3.7	9.0	32.5
L4N8x6-PT1/8	8x6	R1/8	22.9	21.0	29.8	29.1	11.0	4.6	16	12.0	14.0	5.0	4.7	14.0	31.0
L4N8x6-PT1/4	8x6	R1/4	22.9	22.0	29.8	30.1	12.0	4.6	16	12.0	14.0	7.0	4.7	15.0	32.5
L4N8x6-PT3/8	8x6	R3/8	22.9	26.0	31.0	34.1	13.0	4.6	16	14.0	14.0	9.0	4.7	15.0	45.0
L4N10x6.5-PT1/4	10x6.5	R1/4	27.1	25.0	35.2	34.8	13.5	4.2	17	14.0	17.0	7.0	5.2	18.0	47.0
L4N10x6.5-PT3/8	10x6.5	R3/8	27.1	26.0	35.2	35.8	13.0	4.2	17	14.0	17.0	9.0	5.2	18.0	50.0
L4N10x7.5-PT1/4	10x7.5	R1/4	27.1	25.0	35.2	34.8	13.5	4.2	17	14.0	17.0	7.0	6.2	24.0	48.0
L4N10x7.5-PT3/8	10x7.5	R3/8	27.1	26.0	35.2	35.8	13.0	4.2	17	14.0	17.0	9.0	6.2	26.0	51.0
L4N10x7.5-PT1/2	10x7.5	R1/2	27.1	33.0	37.9	42.8	18.0	4.2	17	14.0	17.0	10.0	6.2	26.0	83.0
L4N10x8-PT1/4	10x8	R1/4	27.1	25.0	35.2	34.8	13.5	4.2	17	14.0	17.0	7.0	6.7	25.0	48.0
L4N10x8-PT3/8	10x8	R3/8	27.1	26.0	35.2	35.8	13.0	4.2	17	14.0	17.0	9.0	6.7	25.0	51.0
L4N10x8-PT1/2	10x8	R1/2	27.1	33.0	37.9	42.8	18.0	4.2	17	14.0	17.0	10.0	6.7	30.0	83.0
L4N12x8-PT3/8	12x8	R3/8	27.6	26.0	35.7	37.0	13.0	4.8	18	14.0	19.0	9.0	6.6	25.0	53.0
L4N12x8-PT1/2	12x8	R1/2	30.1	33.0	40.9	44.0	18.0	4.8	18	14.0	19.0	10.0	6.6	30.0	90.0
L4N12x9-PT1/4	12x9	R1/4	27.6	25.0	35.7	36.0	13.5	4.8	18	14.0	19.0	7.0	7.6	33.0	50.0
L4N12x9-PT3/8	12x9	R3/8	27.6	26.0	35.7	37.0	13.0	4.8	18	14.0	19.0	9.0	7.6	33.0	54.0
L4N12x9-PT1/2	12x9	R1/2	30.6	33.0	41.4	44.0	18.0	4.8	18	14.0	19.0	10.0	7.6	33.0	91.0
L4N16x13-PT1/2	16x13	R1/2	36.7	33.0	47.1	48.6	18.0	5.1	23	18.0	27.0	12.0	11.0	72.0	120.0

● Inch size type (Group 1)

Product number	Applicable tube outer diameter (inch)	T Thread size (R)	L1 (mm)	L2 (mm)	L3 (mm)	L4 (mm)	A (mm)	S (mm)	F Tube insertion length (mm)	H1 Width across flat (mm)	H2 Width across flat (mm)	d1 (mm)	d2 Min. inner diameter (mm)	Effective cross-sectional area (mm ²)	Weight (g)
L1N1/8-PT1/8	1/8	R1/8	20.5	18.5	26.3	24.3	11.0	4.6	15	10.0	8.0	5.0	1.4	1.5	15.0
L1N3/16-PT1/8	3/16	R1/8	20.6	18.5	26.3	24.3	11.0	4.6	15	10.0	10.0	5.0	2.4	4.0	18.0
L1N3/16-PT1/4	3/16	R1/4	23.1	22.0	30.0	28.9	12.0	4.6	15	12.0	10.0	7.0	2.4	4.0	28.0
L1N1/4-PT1/8	1/4	R1/8	20.5	18.5	26.3	25.4	11.0	4.6	15	10.0	12.0	5.0	3.4	8.0	20.0
L1N1/4-PT1/4	1/4	R1/4	23.0	22.0	29.8	28.9	12.0	4.6	15	10.0	12.0	7.0	3.4	8.0	26.0
L1N1/4-PT3/8	1/4	R3/8	26.0	26.0	34.6	34.1	13.0	4.6	15	14.0	12.0	9.0	3.4	8.0	44.0
L1N5/16-PT1/8	5/16	R1/8	22.8	21.0	29.8	29.1	11.0	4.6	16	12.0	14.0	5.0	4.7	15.0	30.0
L1N5/16-PT1/4	5/16	R1/4	22.8	22.0	29.8	30.1	12.0	4.6	16	12.0	14.0	7.0	4.7	15.0	32.0
L1N5/16-PT3/8	5/16	R3/8	25.8	26.0	34.4	34.1	13.0	4.6	16	14.0	14.0	9.0	4.7	15.0	48.0
L1N3/8-PT1/8	3/8	R1/8	23.7	21.0	30.6	30.8	11.0	4.6	17	12.0	17.0	5.0	5.7	15.0	35.0
L1N3/8-PT1/4	3/8	R1/4	23.7	22.0	30.6	31.8	12.0	4.6	17	12.0	17.0	7.0	5.7	19.0	50.0
L1N3/8-PT3/8	3/8	R3/8	26.7	26.0	35.2	35.8	13.0	4.6	17	12.0	17.0	7.0	5.7	19.0	50.0
L1N3/8-PT1/2	3/8	R1/2	26.7	33.0	37.5	42.8	18.0	4.6	17	14.0	17.0	10.0	5.7	22.5	84.0
L1N1/2-PT1/4	1/2	R1/4	27.8	25.0	35.9	36.0	13.5	4.6	18	14.0	19.0	7.0	8.2	32.0	50.0
L1N1/2-PT3/8	1/2	R3/8	27.8	26.0	36.3	37.0	13.0	4.6	18	14.0	19.0	9.0	8.2	32.0	53.0
L1N1/2-PT1/2	1/2	R1/2	30.8	33.0	41.6	44.0	18.0	4.6	18	14.0	19.0	10.0	8.2	32.0	76.0
L1N5/8-PT3/8	5/8	R3/8	36.7	28.0	47.1	43.6	15.0	5.1	23	18.0	27.0	9.0	9.3	48.0	107.0
L1N5/8-PT1/2	5/8	R1/2	36.7	33.0	47.5	48.6	18.0	5.1	23	18.0	27.0	12.0	9.3	53.0	117.0

● Inch size type (Group 2)

Product number	Applicable tube outer diameter (inch)	T Thread size (R)	L1 (mm)	L2 (mm)	L3 (mm)	L4 (mm)	A (mm)	S (mm)	F Tube insertion length (mm)	H1 Width across flat (mm)	H2 Width across flat (mm)	d1 (mm)	d2 Min. inner diameter (mm)	Effective cross-sectional area (mm ²)	Weight (g)
L2N1/8-PT1/8	1/8	R1/8	20.5	18.5	26.3	24.3	11.0	4.6	21	10.0	8.0	5.0	3.0	1.5	16.0
L2N3/16-PT1/8	3/16	R1/8	20.6	18.5	26.3	24.3	11.0	4.6	15	10.0	10.0	5.0	1.4	1.5	19.0
L2N1/4-PT1/8	1/4	R1/8	20.5	18.5	26.3	25.4	11.0	4.6	15	10.0	12.0	5.0	2.2	3.5	21.0
L2N1/4-PT1/4	1/4	R1/4	23.0	22.0	30.0	28.9	12.0	4.6	15	12.0	12.0	7.0	2.2	3.5	31.0
L2N5/16-PT1/8	5/16	R1/8	22.8	21.0	29.8	29.1	11.0	4.6	16	12.0	14.0	5.0	2.9	5.0	31.0
L2N5/16-PT1/4	5/16	R1/4	22.8	22.0	29.8	30.1	12.0	4.6	16	12.0	14.0	7.0	2.9	5.0	33.0
L2N3/8-PT1/4	3/8	R1/4	23.7	22.0	30.6	31.8	12.0	4.6	17	12.0	17.0	7.0	3.5	7.5	37.0
L2N3/8-PT3/8	3/8	R3/8	26.7	26.0	35.2	35.8	13.0	4.6	17	14.0	17.0	7.0	3.5	7.5	55.0
L2N1/2-PT1/4	1/2	R1/4	27.8	25.0	35.9	36.0	13.5	4.6	18	14.0	19.0	7.0	5.2	18.0	54.0
L2N1/2-PT3/8	1/2	R3/8	27.8	26.0	36.3	37.0	13.0	4.6	18	14.0	19.0	9.0	5.2	18.0	57.0
L2N1/2-PT1/2	1/2	R1/2	30.3	33.0	41.1	44.0	18.0	4.6	18	18.0	19.0	12.0	5.2	18.0	89.0

☆L2N1/8-PT1/8 is of insertless type.

Tube

Clean tube

Processed tube

PushOne fitting

QuickSeal fitting

Clean fitting/ Chemfit

Bamboo-shoot fitting

Control switch/ Detachable series

Jig/Tool/ Accessory

Technical information

Reference

QuickSeal Series Insertion type (brass)

Tee

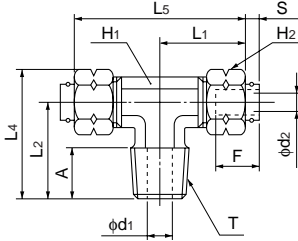

●Millimeter size type (Group 4)

Product number	Applicable tube outer diameter/inner diameter (mm)	T Thread size (R)	L1 (mm)	L2 (mm)	L4 (mm)	L5 (mm)	A (mm)	S (mm)	F Tube insertion length (mm)	H1 Width across flat (mm)	H2 Width across flat (mm)	d1 (mm)	d2 Min. inner diameter (mm)	Effective cross-sectional area (mm ²)	Weight (g)
T4N4x2-PT1/8	4x2	R1/8	20.5	18.5	24.3	41.0	11.0	4.7	15	10.0	10.0	5.0	0.9	0.5	25.0
T4N4x2.5-PT1/8	4x2.5	R1/8	20.5	18.5	24.3	41.0	11.0	4.7	15	10.0	10.0	5.0	1.3	1.5	25.0
T4N4x3-PT1/8	4x3	R1/8	20.5	18.5	24.3	41.0	11.0	4.7	15	10.0	10.0	5.0	2.0	2.5	25.0
T4N6x4-PT1/8	6x4	R1/8	20.5	18.5	25.4	41.0	11.0	4.6	15	10.0	12.0	5.0	2.7	4.5	30.0
T4N6x4-PT1/4	6x4	R1/4	23.0	22.0	28.9	46.0	12.0	4.6	15	12.0	12.0	7.0	2.7	4.5	43.0
T4N6x4.5-PT1/8	6x4.5	R1/8	20.5	18.5	25.4	41.0	11.0	4.6	15	10.0	12.0	5.0	3.2	7.0	31.0
T4N6x4.5-PT1/4	6x4.5	R1/4	23.0	22.0	28.9	46.0	12.0	4.6	15	12.0	12.0	7.0	3.2	7.0	43.0
T4N8x5-PT1/8	8x5	R1/8	22.9	21.0	29.1	45.8	11.0	4.6	16	12.0	14.0	5.0	3.7	9.0	43.0
T4N8x5-PT1/4	8x5	R1/4	22.9	22.0	30.1	45.8	12.0	4.6	16	12.0	14.0	7.0	3.7	9.0	45.0
T4N8x6-PT1/8	8x6	R1/8	22.9	21.0	29.1	45.8	11.0	4.6	16	12.0	14.0	5.0	4.7	14.0	42.0
T4N8x6-PT1/4	8x6	R1/4	22.9	22.0	30.1	45.8	12.0	4.6	16	12.0	14.0	7.0	4.7	15.0	44.0
T4N8x6-PT3/8	8x6	R3/8	22.9	26.0	34.1	45.8	13.0	4.6	16	14.0	14.0	9.0	4.7	15.0	58.0
T4N10x6.5-PT1/4	10x6.5	R1/4	27.1	25.0	34.8	54.2	12.0	4.2	17	14.0	17.0	7.0	5.2	18.0	73.0
T4N10x6.5-PT3/8	10x6.5	R3/8	28.1	26.0	35.8	56.2	13.0	4.2	17	14.0	17.0	9.0	5.2	18.0	78.0
T4N10x7.5-PT1/4	10x7.5	R1/4	27.1	25.0	34.8	54.2	12.0	4.2	17	14.0	17.0	7.0	6.2	24.0	70.0
T4N10x7.5-PT3/8	10x7.5	R3/8	27.1	26.0	35.8	54.2	13.0	4.2	17	14.0	17.0	9.0	6.2	26.0	76.0
T4N10x7.5-PT1/2	10x7.5	R1/2	27.1	33.0	43.4	54.2	18.0	4.2	17	18.0	17.0	12.0	6.2	26.0	110.0
T4N10x8-PT1/4	10x8	R1/4	27.1	25.0	34.8	54.2	12.0	4.2	17	14.0	17.0	7.0	6.7	25.0	69.0
T4N10x8-PT3/8	10x8	R3/8	27.1	26.0	35.8	54.2	13.0	4.2	17	14.0	17.0	9.0	6.7	25.0	75.0
T4N10x8-PT1/2	10x8	R1/2	27.1	33.0	43.4	54.2	18.0	4.2	17	18.0	17.0	12.0	6.7	30.0	109.0
T4N12x8-PT3/8	12x8	R3/8	27.6	25.0	36.0	55.3	13.0	4.8	18	14.0	19.0	9.0	6.6	25.0	82.0
T4N12x8-PT1/2	12x8	R1/2	30.6	33.0	44.0	61.3	18.0	4.8	18	18.0	19.0	12.0	6.6	30.0	128.0
T4N12x9-PT1/4	12x9	R1/4	27.6	25.0	36.0	55.3	12.0	4.8	18	14.0	19.0	7.0	7.6	33.0	75.0
T4N12x9-PT3/8	12x9	R3/8	27.6	26.0	37.0	55.3	13.0	4.8	18	14.0	19.0	9.0	7.6	33.0	82.0
T4N12x9-PT1/2	12x9	R1/2	30.6	33.0	44.0	61.3	18.0	4.8	18	18.0	19.0	12.0	7.6	33.0	128.0
T4N16x13-PT1/2	16x13	R1/2	36.7	33.0	48.6	73.4	18.0	5.1	23	18.0	27.0	12.0	11.0	72.0	165.0

*Made to order

●Inch size type (Group 1)

Product number	Applicable tube outer diameter (inch)	T Thread size (R)	L1 (mm)	L2 (mm)	L4 (mm)	L5 (mm)	A (mm)	S (mm)	F Tube insertion length (mm)	H1 Width across flat (mm)	H2 Width across flat (mm)	d1 (mm)	d2 Min. inner diameter (mm)	Effective cross-sectional area (mm ²)	Weight (g)
T1N1/8-PT1/8	1/8	R1/8	20.5	18.5	24.3	41.1	11.0	4.6	15	10.0	8.0	5.0	1.4	1.5	21.0
T1N3/16-PT1/8	3/16	R1/8	20.6	18.5	24.3	41.1	11.0	4.6	15	10.0	10.0	5.0	2.4	4.0	26.0
T1N1/4-PT1/8	1/4	R1/8	20.5	18.5	25.4	41.1	11.0	4.6	15	10.0	12.0	5.0	3.4	8.0	29.0
T1N1/4-PT1/4	1/4	R1/4	23.0	22.0	28.9	46.1	12.0	4.6	15	12.0	12.0	7.0	3.4	8.0	42.0
T1N5/16-PT1/8	5/16	R1/8	22.8	21.0	29.1	45.7	11.0	4.6	16	12.0	14.0	5.0	4.7	15.0	42.0
T1N5/16-PT1/4	5/16	R1/4	22.8	22.0	30.1	45.7	12.0	4.6	16	12.0	14.0	7.0	4.7	15.0	45.0
T1N5/16-PT3/8	5/16	R3/8	25.8	26.0	34.1	51.7	13.0	4.6	16	14.0	14.0	9.0	4.7	15.0	66.0
T1N3/8-PT1/4	3/8	R1/4	23.7	22.0	31.8	47.4	12.0	4.6	17	12.0	17.0	7.0	5.7	19.0	55.0
T1N3/8-PT3/8	3/8	R3/8	26.7	26.0	35.8	53.4	13.0	4.6	17	14.0	17.0	9.0	5.7	19.0	77.0
T1N3/8-PT1/2	3/8	R1/2	29.7	33.0	43.4	59.4	18.0	4.6	17	18.0	17.0	12.0	5.7	22.5	122.0
T1N1/2-PT3/8	1/2	R3/8	27.8	26.0	37.0	55.6	13.0	4.6	18	14.0	19.0	9.0	8.2	32.0	79.0
T1N1/2-PT1/2	1/2	R1/2	30.8	33.0	44.0	61.6	18.0	4.6	18	18.0	19.0	12.0	8.2	32.0	119.0
T1N5/8-PT3/8	5/8	R3/8	36.7	28.0	43.6	73.3	13.0	5.1	23	18.0	27.0	9.0	9.3	48.0	130.0
T1N5/8-PT1/2	5/8	R1/2	36.7	33.0	48.6	73.3	18.0	5.1	23	18.0	27.0	12.0	9.3	53.0	172.0

●Inch size type (Group 2)

Product number	Applicable tube outer diameter (inch)	T Thread size (R)	L1 (mm)	L2 (mm)	L3 (mm)	L4 (mm)	A (mm)	S (mm)	F Tube insertion length (mm)	H1 Width across flat (mm)	H2 Width across flat (mm)	d1 (mm)	d2 Min. inner diameter (mm)	Effective cross-sectional area (mm ²)	Weight (g)
T2N1/8-PT1/8	1/8	R1/8	20.5	18.5	24.3	41.1	11.0	4.6	21	10.0	8.0	5.0	3.0	1.5	20.5
T2N3/16-PT1/8	3/16	R1/8	20.6	18.5	24.3	41.1	11.0	4.6	15	10.0	10.0	5.0	1.4	1.5	25.0
T2N1/4-PT1/8	1/4	R1/8	20.5	18.5	25.4	41.1	11.0	4.6	15	10.0	12.0	5.0	2.2	3.5	30.0
T2N1/4-PT1/4	1/4	R1/4	23.0	22.0	28.9	46.1	12.0	4.6	15	12.0	12.0	7.0	2.2	3.5	43.0
T2N5/16-PT1/8	5/16	R1/8	22.8	21.0	29.1	45.7	11.0	4.6	16	12.0	14.0	5.0	2.9	5.0	45.0
T2N5/16-PT1/4	5/16	R1/4	22.8	22.0	30.1	45.7	12.0	4.6	16	12.0	14.0	7.0	2.9	5.0	43.0
T2N3/8-PT1/4	3/8	R1/4	23.7	22.0	31.8	47.4	12.0	4.6	17	12.0	17.0	7.0	3.5	7.5	57.0
T2N3/8-PT3/8	3/8	R3/8	26.7	26.0	35.8	53.4	13.0	4.6	17	14.0	17.0	9.0	3.5	7.5	78.0
T2N1/2-PT3/8	1/2	R3/8	27.8	26.0	37.0	55.6	13.0	4.6	18	14.0	19.0	9.0	5.2	18.0	80.0

☆C2N1/8-PT1/8 is of insertless type.

Tube

Clean tube

Processed tube

PushOne fitting

QuickSeal fitting

Clean fitting/ Chemifit

Bamboo-shoot fitting

Control switch/ Detachable series

Jig/Tool/ Accessory

Technical information

Reference

Service tee

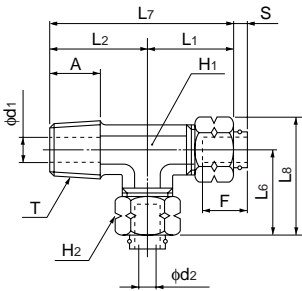

●Millimeter size type (Group 4)

Product number	Applicable tube outer diameter (mm)	T Thread size (R)	L1 (mm)	L2 (mm)	L5 (mm)	L7 (mm)	L8 (mm)	A (mm)	S (mm)	F Tube insertion length (mm)	H1 Width across flat (mm)	H2 Width across flat (mm)	d1 (mm)	d2 Min. inner diameter (mm)	Effective cross-sectional area (mm ²)	Weight (g)
ST4N4×2-PT1/8	4×2	R1/8	20.5	18.5	20.5	39.0	26.2	11.0	4.7	15	10.0	10.0	5.0	0.9	0.5	26.0
ST4N4×2.5-PT1/8	4×2.5	R1/8	20.5	18.5	20.5	39.0	26.2	11.0	4.7	15	10.0	10.0	5.0	1.3	1.5	26.0
ST4N4×3-PT1/8	4×3	R1/8	20.5	18.5	20.5	39.0	26.2	11.0	4.7	15	10.0	10.0	5.0	2.0	2.5	26.0
ST4N6×4-PT1/8	6×4	R1/8	20.5	18.5	20.5	39.0	27.4	11.0	4.6	15	10.0	12.0	5.0	2.7	4.5	41.0
ST4N6×4-PT1/4	6×4	R1/4	23.0	22.0	23.0	45.0	29.9	12.0	4.6	15	12.0	12.0	7.0	2.7	4.5	30.0
ST4N6×4.5-PT1/8	6×4.5	R1/8	20.5	18.5	20.5	39.0	27.4	11.0	4.6	15	10.0	12.0	5.0	3.2	7.0	41.0
ST4N6×4.5-PT1/4	6×4.5	R1/4	23.0	22.0	23.0	45.0	29.9	12.0	4.6	15	12.0	12.0	7.0	3.2	7.0	43.0
ST4N8×5-PT1/8	8×5	R1/8	22.9	21.0	22.9	43.9	31.0	11.0	4.6	16	12.0	14.0	5.0	3.7	9.0	43.0
ST4N8×5-PT1/4	8×5	R1/4	22.9	22.0	22.9	44.9	31.0	12.0	4.6	16	12.0	14.0	7.0	3.7	9.0	43.0
ST4N8×6-PT1/8	8×6	R1/8	22.9	21.0	22.9	43.9	31.0	11.0	4.6	16	12.0	14.0	5.0	4.7	14.0	45.0
ST4N8×6-PT1/4	8×6	R1/4	22.9	22.0	22.9	44.9	31.0	12.0	4.6	16	12.0	14.0	7.0	4.7	15.0	46.0
ST4N8×6-PT3/8	8×6	R3/8	22.9	26.0	22.9	48.9	31.0	13.0	4.6	16	14.0	14.0	9.0	4.7	15.0	60.0
ST4N10×6.5-PT1/4	10×6.5	R1/4	27.1	25.0	27.1	52.1	36.9	12.0	4.2	17	14.0	17.0	7.0	5.2	18.0	72.0
ST4N10×6.5-PT3/8	10×6.5	R3/8	27.1	26.0	27.1	53.1	36.9	13.0	4.2	17	14.0	17.0	9.0	5.2	18.0	70.0
ST4N10×7.5-PT1/4	10×7.5	R1/4	27.1	25.0	27.1	52.1	36.9	12.0	4.2	17	14.0	17.0	7.0	6.2	24.0	70.0
ST4N10×7.5-PT3/8	10×7.5	R3/8	27.1	26.0	27.1	53.1	36.9	13.0	4.2	17	14.0	17.0	9.0	6.2	26.0	76.0
ST4N10×7.5-PT1/2	10×7.5	R1/2	27.1	35.5	27.1	62.6	37.5	18.0	4.2	17	18.0	17.0	12.0	6.2	26.0	74.0
ST4N10×8-PT1/4	10×8	R1/4	27.1	25.0	27.1	52.1	36.9	12.0	4.2	17	14.0	17.0	7.0	6.7	25.0	76.0
ST4N10×8-PT3/8	10×8	R3/8	27.1	26.0	27.1	53.1	36.9	13.0	4.2	17	14.0	17.0	9.0	6.7	25.0	113.0
ST4N10×8-PT1/2	10×8	R1/2	27.1	35.5	27.1	62.6	37.5	18.0	4.2	17	18.0	17.0	12.0	6.7	30.0	125.0
ST4N12×8-PT3/8	12×8	R3/8	27.6	26.0	27.6	53.6	38.6	13.0	4.8	18	14.0	19.0	9.0	6.6	25.0	81.0
ST4N12×8-PT1/2	12×8	R1/2	30.1	35.5	30.1	65.6	41.1	18.0	4.8	18	18.0	19.0	12.0	6.6	30.0	82.0
ST4N12×9-PT3/8	12×9	R3/8	27.6	26.0	27.6	53.6	38.6	13.0	4.8	18	14.0	19.0	9.0	7.6	33.0	130.0
ST4N12×9-PT1/2	12×9	R1/2	30.1	35.5	30.1	65.6	41.1	18.0	4.8	18	18.0	19.0	12.0	7.6	33.0	128.0

*Made to order

●Inch size type (Group 1)

Product number	Applicable tube outer diameter (inch)	T Thread size (R)	L1 (mm)	L2 (mm)	L5 (mm)	L7 (mm)	L8 (mm)	A (mm)	S (mm)	F Tube insertion length (mm)	H1 Width across flat (mm)	H2 Width across flat (mm)	d1 (mm)	d2 Min. inner diameter (mm)	Effective cross-sectional area (mm ²)	Weight (g)
ST1N1/8-PT1/8	1/8	R1/8	20.5	18.5	20.5	39.0	26.3	11.0	4.6	15	10.0	8.0	5.0	1.4	1.5	22.0
ST1N3/16-PT1/8	3/16	R1/8	20.6	18.5	20.6	39.1	26.3	11.0	4.6	15	10.0	10.0	5.0	2.4	4.0	25.0
ST1N3/16-PT1/4	3/16	R1/4	23.1	22.0	23.1	45.1	30.0	12.0	4.6	15	12.0	10.0	7.0	2.4	4.0	37.0
ST1N1/4-PT1/8	1/4	R1/8	20.5	18.5	20.5	39.0	27.5	11.0	4.6	15	10.0	12.0	5.0	3.4	8.0	29.0
ST1N1/4-PT1/4	1/4	R1/4	23.0	22.0	23.0	45.0	30.0	12.0	4.6	15	12.0	12.0	7.0	3.4	8.0	41.0
ST1N5/16-PT1/8	5/16	R1/8	22.8	21.0	22.8	43.8	30.9	11.0	4.6	16	12.0	14.0	5.0	4.7	15.0	44.0
ST1N5/16-PT1/4	5/16	R1/4	22.8	22.0	22.8	44.8	30.9	12.0	4.6	16	12.0	14.0	7.0	4.7	15.0	45.0
ST1N3/8-PT1/4	3/8	R1/4	23.7	22.0	23.7	45.7	33.5	12.0	4.6	17	12.0	17.0	7.0	5.7	19.0	56.0
ST1N3/8-PT3/8	3/8	R3/8	26.7	26.0	26.7	52.7	36.5	13.0	4.6	17	14.0	17.0	9.0	5.7	19.0	77.0
ST1N3/8-PT1/2	3/8	R1/2	29.2	35.5	29.2	64.7	39.6	18.0	4.6	17	18.0	17.0	12.0	5.7	22.5	124.0
ST1N1/2-PT3/8	1/2	R3/8	27.8	26.0	27.8	53.8	38.8	13.0	4.6	18	14.0	19.0	9.0	8.2	32.0	81.0
ST1N1/2-PT1/2	1/2	R1/2	30.3	35.5	30.3	65.8	41.3	18.0	4.6	18	18.0	19.0	12.0	8.2	32.0	122.0
ST1N5/8-PT1/2	5/8	R1/2	36.7	35.5	36.7	72.2	52.3	18.0	5.1	23	18.0	27.0	12.0	9.3	53.0	179.0

*Made to order

●Inch size type (Group 2)

Product number	Applicable tube outer diameter (inch)	T Thread size (R)	L1 (mm)	L2 (mm)	L5 (mm)	L7 (mm)	L8 (mm)	A (mm)	S (mm)	F Tube insertion length (mm)	H1 Width across flat (mm)	H2 Width across flat (mm)	d1 (mm)	d2 Min. inner diameter (mm)	Effective cross-sectional area (mm ²)	Weight (g)
ST2N1/8-PT1/8	1/8	R1/8	20.5	18.5	20.5	39.0	26.3	11.0	4.6	21	10.0	8.0	5.0	3.0	1.5	21.0
ST2N3/16-PT1/8	3/16	R1/8	20.6	18.5	20.6	39.1	26.3	11.0	4.6	15	10.0	10.0	5.0	1.4	1.5	25.0
ST2N1/4-PT1/8	1/4	R1/8	20.5	18.5	20.5	39.0	27.5	11.0	4.6	15	10.0	12.0	5.0	2.2	3.5	30.0
ST2N1/4-PT1/4	1/4	R1/4	23.0	22.0	23.0	45.0	30.0	12.0	4.6	15	12.0	12.0	7.0	2.2	3.5	43.0
ST2N5/16-PT1/8	5/16	R1/8	22.8	21.0	22.8	43.8	30.9	11.0	4.6	16	12.0	14.0	5.0	2.9	5.0	45.0
ST2N5/16-PT1/4	5/16	R1/4	22.8	22.0	22.8	44.8	30.9	12.0	4.6	16	12.0	14.0	7.0	2.9	5.0	47.0
ST2N3/8-PT1/4	3/8	R1/4	23.7	22.0	23.7	45.7	33.5	12.0	4.6	17	12.0	17.0	7.0	3.5	7.5	58.0
ST2N3/8-PT3/8	3/8	R3/8	26.7	26.0	26.7	52.7	36.5	13.0	4.6	17	14.0	17.0	9.0	3.5	7.5	77.0
ST2N1/2-PT3/8	1/2	R3/8	27.8	26.0	27.8	53.8	38.8	13.0	4.6	18	14.0	19.0	9.0	5.2	18.0	78.0

☆C2N1/8-PT1/8 is of insertless type.

*Made to order

Internal connector

●Millimeter size type (Group 4)

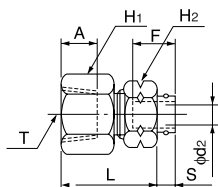

Product number	Applicable tube outer diameter, inner diameter (mm)	T Thread size (Rc)	L (mm)	A (mm)	S (mm)	F Tube insertion length (mm)	H ₁ Width across flat (mm)	H ₂ Width across flat (mm)	d ₂ Min. inner diameter (mm)	Effective cross-sectional area (mm ²)	Weight (g)
FC4N4x2-PT1/8	4x2	Rc1/8	25.0	8.7	4.7	15	14.0	10.0	0.9	0.5	18.0
FC4N4x3-PT1/8	4x3	Rc1/8	25.0	8.7	4.7	15	14.0	10.0	2.0	3.0	18.0
FC4N6x4-PT1/8	6x4	Rc1/8	25.0	8.7	4.6	15	14.0	12.0	2.7	5.0	20.0
FC4N6x4-PT1/4	6x4	Rc1/4	29.0	13.0	4.6	15	17.0	12.0	2.7	5.0	29.0
FC4N6x4-PT3/8	6x4	Rc3/8	30.0	13.5	4.6	15	22.0	12.0	2.7	5.0	43.0
FC4N6x4.5-PT1/8	6x4.5	Rc1/8	25.0	8.7	4.6	15	14.0	12.0	3.2	7.5	20.0
FC4N6x4.5-PT1/4	6x4.5	Rc1/4	29.0	13.0	4.6	15	17.0	12.0	3.2	7.5	29.0
FC4N8x6-PT1/8	8x6	Rc1/8	24.9	8.7	4.6	16	14.0	14.0	4.7	16.0	22.0
FC4N8x6-PT1/4	8x6	Rc1/4	28.9	13.0	4.6	16	17.0	14.0	4.7	16.0	31.0
FC4N8x6-PT3/8	8x6	Rc3/8	29.9	13.5	4.6	16	22.0	14.0	4.7	16.0	48.0
FC4N10x7.5-PT1/4	10x7.5	Rc1/4	30.1	13.0	4.2	17	17.0	17.0	6.2	30.0	35.0
FC4N10x7.5-PT3/8	10x7.5	Rc3/8	31.1	13.5	4.2	17	22.0	17.0	6.2	30.0	51.0
FC4N10x7.5-PT1/2	10x7.5	Rc1/2	35.1	17.5	4.2	17	24.0	17.0	6.2	30.0	59.0
FC4N10x8-PT1/4	10x8	Rc1/4	30.1	13.0	4.2	17	17.0	17.0	6.7	32.0	35.0
FC4N10x8-PT3/8	10x8	Rc3/8	31.1	13.5	4.2	17	22.0	17.0	6.7	32.0	51.0
FC4N10x8-PT1/2	10x8	Rc1/2	35.1	17.5	4.2	17	24.0	17.0	6.7	32.0	58.0
FC4N12x9-PT3/8	12x9	Rc3/8	31.6	13.5	4.8	18	22.0	19.0	7.6	40.0	55.0
FC4N12x9-PT1/2	12x9	Rc1/2	35.6	17.5	4.8	18	24.0	19.0	7.6	40.0	62.0

*Made to order

●Inch size type (Group 1)

Product number	Applicable tube outer diameter (inch)	T Thread size (Rc)	L (mm)	A (mm)	S (mm)	F Tube insertion length (mm)	H ₁ Width across flat (mm)	H ₂ Width across flat (mm)	d ₂ Min. inner diameter (mm)	Effective cross-sectional area (mm ²)	Weight (g)
FC1N3/16-PT1/8	3/16	Rc1/8	25.1	8.7	4.6	15	14.0	10.0	2.4	4.0	17.0
FC1N1/4-PT1/8	1/4	Rc1/8	25.0	8.7	4.6	15	14.0	12.0	3.4	8.5	19.0
FC1N1/4-PT1/4	1/4	Rc1/4	29.0	13.0	4.6	15	17.0	12.0	3.4	8.5	29.0
FC1N5/16-PT1/8	5/16	Rc1/8	24.8	8.7	4.6	16	14.0	14.0	4.7	16.0	22.0
FC1N5/16-PT1/4	5/16	Rc1/4	28.8	13.0	4.6	16	17.0	14.0	4.7	16.0	30.0
FC1N5/16-PT3/8	5/16	Rc3/8	29.8	13.5	4.6	16	22.0	14.0	4.7	16.0	45.0
FC1N3/8-PT1/4	3/8	Rc1/4	29.7	13.0	4.6	17	17.0	17.0	5.7	22.5	35.0
FC1N3/8-PT3/8	3/8	Rc3/8	30.7	13.5	4.6	17	22.0	17.0	5.7	22.5	52.0
FC1N3/8-PT1/2	3/8	Rc1/2	34.7	17.5	4.6	17	24.0	17.0	5.7	22.5	60.0
FC1N1/2-PT3/8	1/2	Rc3/8	31.8	13.5	4.6	18	22.0	19.0	8.2	45.0	54.0
FC1N1/2-PT1/2	1/2	Rc1/2	35.8	17.5	4.6	18	24.0	19.0	8.2	45.0	61.0

Union connector

●Millimeter size type (Group 4)

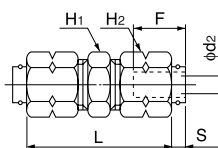

Product number	Applicable tube outer diameter (mm)	L (mm)	S (mm)	F Tube insertion length (mm)	H ₁ Width across flat (mm)	H ₂ Width across flat (mm)	d ₂ Min. inner diameter (mm)	Effective cross-sectional area (mm ²)	Weight (g)
UC4N4x2	4x2	32.9	4.7	15	10.0	10.0	0.9	0.5	16.0
UC4N4x2.5	4x2.5	32.9	4.7	15	10.0	10.0	1.3	1.5	16.0
UC4N4x3	4x3	32.9	4.7	15	10.0	10.0	2.0	3.0	16.0
UC4N6x4	6x4	33.0	4.6	15	10.0	12.0	2.7	5.0	20.0
UC4N6x4.5	6x4.5	33.0	4.6	15	10.0	12.0	3.2	7.5	20.0
UC4N8x5	8x5	32.8	4.6	16	12.0	14.0	3.7	10.0	28.0
UC4N8x6	8x6	32.8	4.6	16	12.0	14.0	4.7	16.0	25.0
UC4N10x6.5	10x6.5	36.2	4.2	17	17.0	17.0	5.2	20.5	44.0
UC4N10x7.5	10x7.5	36.2	4.2	17	17.0	17.0	6.2	30.0	45.0
UC4N10x8	10x8	36.2	4.2	17	17.0	17.0	6.7	32.0	44.0
UC4N12x8	12x8	37.3	4.8	18	17.0	19.0	6.6	32.0	49.0
UC4N12x9	12x9	37.3	4.8	18	17.0	19.0	7.6	40.0	51.0

●Inch size type (Group 1)

Product number	Applicable tube outer diameter (inch)	L (mm)	S (mm)	F Tube insertion length (mm)	H ₁ Width across flat (mm)	H ₂ Width across flat (mm)	d ₂ Min. inner diameter (mm)	Effective cross-sectional area (mm ²)	Weight (g)
UC1N1/8	1/8	33.1	4.6	15	10.0	8.0	1.4	1.5	13.0
UC1N3/16	3/16	33.1	4.6	15	10.0	10.0	2.4	4.0	16.0
UC1N1/4	1/4	33.1	4.6	15	10.0	12.0	3.4	8.5	20.0
UC1N5/16	5/16	32.7	4.6	16	12.0	14.0	4.7	16.0	25.0
UC1N3/8	3/8	35.4	4.6	17	14.0	17.0	5.7	22.5	40.0
UC1N1/2	1/2	37.6	4.6	18	17.0	19.0	8.2	45.0	47.0

90 degree union elbow

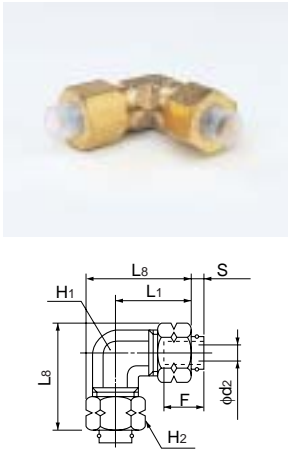

●Millimeter size type (Group 4)

Product number	Applicable tube outer diameter (mm)	L1 (mm)	L8 (mm)	S (mm)	F Tube insertion length (mm)	H1 Width across flat (mm)	H2 Width across flat (mm)	d2 Min. inner diameter (mm)	Effective cross-sectional area (mm ²)	Weight (g)
UL4N4×2	4×2	20.5	26.2	4.7	15	10.0	10.0	0.9	0.6	20.0
UL4N4×2.5	4×2.5	20.5	26.2	4.7	15	10.0	10.0	1.3	1.0	20.0
UL4N4×3	4×3	20.5	26.2	4.7	15	10.0	10.0	2.0	2.0	20.0
UL4N6×4	6×4	20.5	27.4	4.6	15	10.0	12.0	2.7	4.0	25.0
UL4N6×4.5	6×4.5	20.5	27.4	4.6	15	10.0	12.0	3.2	5.5	25.0
UL4N8×5	8×5	22.9	31.0	4.6	16	12.0	14.0	3.7	7.5	37.0
UL4N8×6	8×6	22.9	31.0	4.6	16	12.0	14.0	4.7	12.5	36.0
UL4N10×6.5	10×6.5	27.1	36.9	4.2	17	14.0	17.0	5.2	15.5	59.0
UL4N10×7.5	10×7.5	27.1	36.9	4.2	17	14.0	17.0	6.2	22.0	56.0
UL4N10×8	10×8	27.1	36.9	4.2	17	14.0	17.0	6.7	25.0	57.0
UL4N12×8	12×8	27.6	38.6	4.8	18	14.0	19.0	6.6	25.0	63.0
UL4N12×9	12×9	27.6	38.6	4.8	18	14.0	19.0	7.6	25.0	60.0

●Inch size type (Group 1)

Product number	Applicable tube outer diameter (inch)	L1 (mm)	L8 (mm)	S (mm)	F Tube insertion length (mm)	H1 Width across flat (mm)	H2 Width across flat (mm)	d2 Min. inner diameter (mm)	Effective cross-sectional area (mm ²)	Weight (g)
UL1N1/8	1/8	20.5	26.3	4.6	15	10.0	8.0	1.4	1.0	17.0
UL1N3/16	3/16	20.6	26.3	4.6	15	10.0	10.0	2.4	3.0	20.0
UL1N1/4	1/4	20.5	27.5	4.6	15	10.0	12.0	3.4	6.5	25.0
UL1N5/16	5/16	22.8	30.9	4.6	16	12.0	14.0	4.7	12.5	37.0
UL1N3/8	3/8	23.7	33.5	4.6	17	12.0	17.0	5.7	18.5	47.0
UL1N1/2	1/2	27.8	38.8	4.6	18	14.0	19.0	8.2	30.0	58.0

Union tee

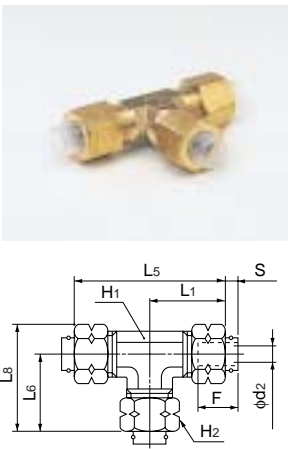

●Millimeter size type (Group 4)

Product number	Applicable tube outer diameter (mm)	L1 (mm)	L5 (mm)	L8 (mm)	L8 (mm)	S (mm)	F Tube insertion length (mm)	H1 Width across flat (mm)	H2 Width across flat (mm)	d2 Min. inner diameter (mm)	Effective cross-sectional area (mm ²)	Weight (g)
UT4N4×2	4×2	20.5	40.9	20.5	26.2	4.7	15	10.0	10.0	0.9	0.6	27.0
UT4N4×2.5	4×2.5	20.5	40.9	20.5	26.2	4.7	15	10.0	10.0	1.3	1.0	28.0
UT4N4×3	4×3	20.5	40.9	20.5	26.2	4.7	15	10.0	10.0	2.0	2.0	26.0
UT4N6×4	6×4	20.5	41.0	20.5	27.4	4.6	15	10.0	12.0	2.7	4.0	35.0
UT4N6×4.5	6×4.5	20.5	41.0	20.5	27.4	4.6	15	10.0	12.0	3.2	5.5	35.0
UT4N8×5	8×5	22.9	45.8	22.9	31.0	4.6	16	12.0	14.0	3.7	7.5	49.0
UT4N8×6	8×6	22.9	45.8	22.9	31.0	4.6	16	12.0	14.0	4.7	12.5	48.0
UT4N10×6.5	10×6.5	27.1	54.2	27.1	36.9	4.2	17	14.0	17.0	5.2	15.5	82.0
UT4N10×7.5	10×7.5	27.1	54.2	27.1	36.9	4.2	17	14.0	17.0	6.2	22.0	80.0
UT4N10×8	10×8	27.1	54.2	27.1	36.9	4.2	17	14.0	17.0	6.7	25.0	77.0
UT4N12×8	12×8	27.6	55.3	27.6	38.6	4.8	18	14.0	19.0	6.6	25.0	90.0
UT4N12×9	12×9	27.6	55.3	27.6	38.6	4.8	18	14.0	19.0	7.6	25.0	85.0

●Inch size type (Group 1)

Product number	Applicable tube outer diameter (inch)	L1 (mm)	L5 (mm)	L8 (mm)	L8 (mm)	S (mm)	F Tube insertion length (mm)	H1 Width across flat (mm)	H2 Width across flat (mm)	d2 Min. inner diameter (mm)	Effective cross-sectional area (mm ²)	Weight (g)
UT1N1/8	1/8	20.5	41.1	20.5	26.3	4.6	15	10.0	8.0	1.4	1.0	22.0
UT1N3/16	3/16	20.6	41.1	20.6	26.3	4.6	15	10.0	10.0	2.4	3.0	28.0
UT1N1/4	1/4	20.5	41.1	20.5	27.5	4.6	15	10.0	12.0	3.4	6.5	34.0
UT1N5/16	5/16	22.8	45.7	22.8	30.9	4.6	16	12.0	14.0	4.7	12.5	49.0
UT1N3/8	3/8	23.7	47.4	23.7	33.5	4.6	17	12.0	17.0	5.7	18.5	64.0
UT1N1/2	1/2	27.8	55.6	27.8	38.8	4.6	18	14.0	19.0	8.2	30.0	84.0
UT1N5/8	5/8	36.7	73.3	36.7	52.3	5.1	23	18.0	27.0	9.3	45.0	189.0

●Inch size type (Group 2)

Product number	Applicable tube outer diameter (inch)	L1 (mm)	L5 (mm)	L8 (mm)	L8 (mm)	S (mm)	F Tube insertion length (mm)	H1 Width across flat (mm)	H2 Width across flat (mm)	d2 Min. inner diameter (mm)	Effective cross-sectional area (mm ²)	Weight (g)
☆ UT2N1/8	1/8	20.5	41.1	20.5	26.3	4.6	21	10.0	8.0	3.0	1.0	21.0
UT2N3/16	3/16	20.6	41.1	20.6	26.3	4.6	15	10.0	10.0	1.4	1.0	27.0
UT2N1/4	1/4	20.5	41.1	20.5	27.5	4.6	15	10.0	12.0	2.2	2.5	34.0
UT2N5/16	5/16	22.8	45.7	22.8	30.9	4.6	16	12.0	14.0	2.9	4.5	52.0
UT2N3/8	3/8	23.7	47.4	23.7	33.5	4.6	17	12.0	17.0	3.5	7.0	67.0
UT2N1/2	1/2	27.8	55.6	27.8	38.8	4.6	18	14.0	19.0	5.2	16.0	92.0

☆ UT2N1/8 is of insertless type.

Swivel nut internal connector

●Millimeter size type (Group 4)

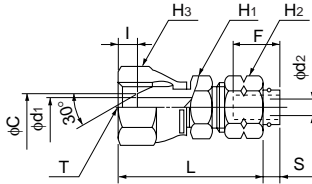

Product number	Applicable tube outer diameter-inner diameter (mm)	T Thread size (G)	L (mm)	S (mm)	I (mm)	F Tube insertion length (mm)	H1 Width across flat (mm)	H2 Width across flat (mm)	H3 Width across flat (mm)	C (mm)	d1 (mm)	d2 Min. inner diameter (mm)	Effective cross-sectional area (mm ²)	Weight (g)
SC4N4×2-PF1/8	4×2	G1/8	33.0	4.7	4.0	15	12.0	10.0	14.0	5.0	2.8	0.9	1.0	24.0
SC4N6×4-PF1/8	6×4	G1/8	33.0	4.6	4.0	15	12.0	12.0	14.0	5.0	2.7	2.7	5.0	26.0
SC4N6×4-PF1/4	6×4	G1/4	34.7	4.6	5.7	15	17.0	12.0	19.0	7.0	5.0	2.7	5.5	44.0
SC4N6×4.5-PF1/8	6×4.5	G1/8	33.0	4.6	4.0	15	12.0	12.0	14.0	5.0	3.2	3.2	6.5	26.0
SC4N6×4.5-PF1/4	6×4.5	G1/4	34.7	4.6	5.7	15	17.0	12.0	19.0	7.0	5.0	3.2	7.5	44.0
SC4N8×6-PF1/4	8×6	G1/4	34.6	4.6	5.7	16	17.0	14.0	19.0	7.0	5.0	4.7	17.0	46.0
SC4N10×7.5-PF1/4	10×7.5	G1/4	38.8	4.2	5.7	17	17.0	17.0	19.0	7.0	5.0	6.2	19.0	56.0
SC4N10×7.5-PF3/8	10×7.5	G3/8	40.9	4.2	6.8	17	19.0	17.0	22.0	10.0	6.2	6.2	19.0	71.0
SC4N10×8-PF1/4	10×8	G1/4	38.8	4.2	5.7	17	17.0	17.0	19.0	7.0	5.0	6.7	19.0	56.0
SC4N10×8-PF3/8	10×8	G3/8	40.9	4.2	6.8	17	19.0	17.0	22.0	10.0	6.7	6.7	34.0	71.0
SC4N12×9-PF3/8	12×9	G3/8	41.4	4.8	6.8	18	19.0	19.0	22.0	10.0	7.6	7.6	44.5	54.0
SC4N12×9-PF1/2	12×9	G1/2	46.1	4.8	9.5	18	22.0	19.0	27.0	14.0	10.0	7.6	44.5	116.0

*Made to order

●Inch size type (Group 1)

Product number	Applicable tube outer diameter (inch)	T Thread size (G)	L (mm)	S (mm)	I (mm)	F Tube insertion length (mm)	H1 Width across flat (mm)	H2 Width across flat (mm)	H3 Width across flat (mm)	C (mm)	d1 (mm)	d2 Min. inner diameter (mm)	Effective cross-sectional area (mm ²)	Weight (g)
SC1N1/8-PF1/8	1/8	G1/8	33.0	4.6	4.0	15	12.0	8.0	14.0	5.0	1.4	1.4	1.5	22.0
SC1N3/16-PF1/8	3/16	G1/8	33.1	4.6	4.0	15	12.0	10.0	14.0	5.0	2.4	2.4	4.0	24.0
SC1N1/4-PF1/8	1/4	G1/8	33.0	4.6	4.0	15	12.0	12.0	14.0	5.0	3.4	3.4	6.5	25.0
SC1N1/4-PF1/4	1/4	G1/4	34.7	4.6	5.7	15	17.0	12.0	19.0	7.0	5.0	3.4	8.5	44.0
SC1N5/16-PF1/4	5/16	G1/4	34.5	4.6	5.7	16	17.0	14.0	19.0	7.0	5.0	4.7	16.5	45.0
SC1N3/8-PF1/4	3/8	G1/4	38.4	4.6	5.7	17	17.0	17.0	19.0	7.0	5.7	5.7	24.0	55.0
SC1N3/8-PF3/8	3/8	G3/8	40.5	4.6	6.8	17	19.0	17.0	22.0	10.0	5.7	5.7	24.0	72.0
SC1N1/2-PF3/8	1/2	G3/8	41.6	4.6	6.8	18	19.0	19.0	22.0	10.0	8.2	8.2	47.0	70.0
SC1N1/2-PF1/2	1/2	G1/2	46.3	4.6	9.5	18	22.0	19.0	27.0	14.0	10.0	8.2	49.0	104.0
SC1N5/8-PF1/2	5/8	G1/2	52.2	5.1	9.5	23	23.0	27.0	27.0	14.0	10.0	9.3	63.0	145.0

*Made to order

●Inch size type (Group 2)

Product number	Applicable tube outer diameter (inch)	T Thread size (G)	L (mm)	S (mm)	I (mm)	F Tube insertion length (mm)	H2 Width across flat (mm)	H4 Width across flat (mm)	H3 Width across flat (mm)	C (mm)	d1 (mm)	d2 Min. inner diameter (mm)	Effective cross-sectional area (mm ²)	Weight (g)
SC2N1/4-PF1/8	1/4	G1/8	33.0	4.6	4.0	15	12.0	12.0	14.0	5.0	2.2	2.2	3.5	25.5
SC2N1/4-PF1/4	1/4	G1/4	34.7	4.6	5.7	15	17.0	12.0	19.0	7.0	5.0	2.2	3.5	44.0
SC2N5/16-PF1/4	5/16	G1/4	34.5	4.6	5.7	16	17.0	14.0	19.0	7.0	5.0	2.9	6.0	45.0
SC2N3/8-PF3/8	3/8	G3/8	40.5	4.6	6.8	17	19.0	17.0	22.0	10.0	5.7	3.5	7.0	72.0
SC2N1/2-PF3/8	1/2	G3/8	41.6	4.6	6.8	18	19.0	19.0	22.0	10.0	5.7	5.2	20.5	70.0

Panel touch connector

●Millimeter size type (Group 4)

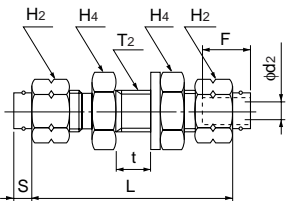

Product number	Applicable tube outer diameter-inner diameter (mm)	L (mm)	S (mm)	F Tube insertion length (mm)	Max. panel thickness (mm)	H2 Width across flat (mm)	H4 Width across flat (mm)	Min. inner diameter (mm)	T2 Recommended panel hole diameter (mm)	Washer outer diameter (mm)	Washer thickness (mm)	Effective cross-sectional area (mm ²)	Weight (g)
UCT4N4×2	4×2	41.5	4.7	15	8.0	10.0	12.0	0.9	9	15	1.6	0.7	25.0
UCT4N4×3	4×3	41.5	4.7	15	8.0	10.0	12.0	2.0	9	15	1.6	3.0	25.0
UCT4N6×4	6×4	42.0	4.6	15	8.4	12.0	14.0	2.7	11	18	1.6	5.0	33.0
UCT4N6×4.5	6×4.5	42.0	4.6	15	8.4	12.0	14.0	3.2	11	18	1.6	7.5	33.0
UCT4N8×6	8×6	43.3	4.6	16	8.4	14.0	17.0	4.7	13	20	2.0	16.0	48.0
UCT4N10×7.5	10×7.5	45.7	4.2	17	8.1	17.0	19.0	6.2	16	24	2.5	30.0	67.0
UCT4N10×8	10×8	45.7	4.2	17	8.1	17.0	19.0	6.7	16	24	2.5	32.0	67.0
UCT4N12×9	12×9	47.3	4.8	18	8.1	19.0	22.0	7.6	18	28	2.5	40.0	87.0

*Made to order

●Inch size type (Group 1)

Product number	Applicable tube outer diameter (inch)	L (mm)	S (mm)	F Tube insertion length (mm)	Max. panel thickness (mm)	H2 Width across flat (mm)	H4 Width across flat (mm)	Min. inner diameter (mm)	T2 Recommended panel hole diameter (mm)	Washer outer diameter (mm)	Washer thickness (mm)	Effective cross-sectional area (mm ²)	Weight (g)
UCT1N1/8	1/8	39.7	4.6	15	8.0	8.0	10.0	1.4	7	11	1.6	1.5	14.5
UCT1N3/16	3/16	41.7	4.6	15	8.0	10.0	12.0	2.4	9	15	1.6	4.0	25.0
UCT1N1/4	1/4	42.1	4.6	15	8.4	12.0	14.0	3.4	11	18	1.6	8.5	32.0
UCT1N5/16	5/16	43.2	4.6	16	8.3	14.0	17.0	4.7	13	20	2.0	16.0	49.0
UCT1N3/8	3/8	44.9	4.6	17	7.7	17.0	19.0	5.7	15	24	2.5	22.5	67.0
UCT1N1/2	1/2	47.6	4.6	18	7.8	19.0	22.0	8.2	18	28	2.5	45.0	86.0

*Made to order

Tube

Clean tube

Processed tube

PushOne fitting

QuickSeal fitting

Clean fitting/Chemifit

Bamboo-shoot fitting

Control switch/Detachable series

Jig/Tool/Accessory

Technical information

Reference

Brass nut

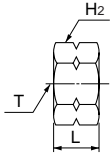

*The inch size type has no cut.

●Millimeter size type (Group 4)

Product number	Applicable tube outer diameter (mm)	T Thread size (M)	L (mm)	H ₂ Width across flat (mm)	Weight (g)
N4	4	M8×0.75	9.0	10.0	4.0
N6	6	M10×1.0	9.0	12.0	5.0
N8	8	M12×1.0	9.0	14.0	6.0
N10	10	M15×1.0	10.0	17.0	9.0
N12	12	M17×1.0	11.0	19.0	11.0
N16	16	M22×1.0	13.0	27.0	33.0

●Inch size type (Group 1)

Product number	Applicable tube outer diameter (inch)	T Thread size (M)	L (mm)	H ₂ Width across flat (mm)	Weight (g)
N1/8	1/8	M6×0.75	9.0	8.0	3.0
N3/16	3/16	M8×0.75	9.0	10.0	4.0
N1/4	1/4	M10×1.0	9.0	12.0	5.0
N5/16	5/16	M12×1.0	9.0	14.0	6.0
N3/8	3/8	M14×1.0	10.0	17.0	10.0
N1/2	1/2	M17×1.0	11.5	19.0	11.0
N5/8	5/8	M22×1.0	13.0	27.0	33.0

Nylon sleeve

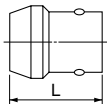

●Millimeter size type (Color: milky white)

Product number	Applicable tube outer diameter (mm)	L (mm)
SN4	4	11.0
SN6	6	11.0
SN8	8	11.0
SN10	10	12.0
SN12	12	13.0
SN16	16	17.0

●Inch size type (Color: black)

Product number	Applicable tube outer diameter (inch)	L (mm)
SN1/8	1/8	11.0
SN3/16	3/16	11.0
SN1/4	1/4	11.0
SN5/16	5/16	11.0
SN3/8	3/8	12.0
SN1/2	1/2	13.0
SN5/8	5/8	17.0

Brass sleeve

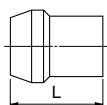

●Millimeter size type

Product number	Applicable tube outer diameter (mm)	L (mm)
MSN4	4	9.0
MSN6	6	9.0
MSN8	8	9.0
MSN10	10	10.0
MSN12	12	11.3
MSN16	16	17.0

●Inch size type

Product number	Applicable tube outer diameter (inch)	L (mm)
MSN1/8	1/8	11.0
MSN3/16	3/16	11.0
MSN1/4	1/4	11.0
MSN5/16	5/16	11.0
MSN3/8	3/8	12.0
MSN1/2	1/2	13.0

Connector (NPT thread)

●Inch size type (Group 1) NPT thread

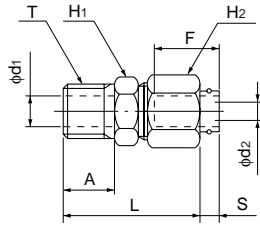

Product number	Applicable tube outer diameter (inch)	T Thread size (NPT)	L (mm)	A (mm)	S (mm)	F Tube insertion length (mm)	H ₁ Width across flat (mm)	H ₂ Width across flat (mm)	d ₁ (mm)	Min. inner diameter (mm)	Effective cross-sectional area (mm ²)	Weight (g)
* C1N1/8-NPT1/8	1/8	NPT1/8	28.0	11.0	4.6	15	10.0	8.0	5.0	1.4	1.5	11.0
* C1N3/16N-PT1/8	3/16	NPT1/8	28.1	11.0	4.6	15	10.0	10.0	5.0	2.4	4.0	13.0
* C1N1/4-NPT1/8	1/4	NPT1/8	28.0	11.0	4.6	15	10.0	12.0	5.0	3.4	8.5	14.0
* C1N1/4-NPT1/4	1/4	NPT1/4	30.0	12.0	4.6	15	14.0	12.0	7.0	3.4	8.5	22.0
* C1N5/16-NPT1/8	5/16	NPT1/8	27.8	11.0	4.6	16	12.0	14.0	5.0	4.7	16.0	17.0
* C1N5/16-NPT1/4	5/16	NPT1/4	29.8	12.0	4.6	16	14.0	14.0	7.0	4.7	16.0	24.0
* C1N3/8-NPT1/4	3/8	NPT1/4	30.7	12.0	4.6	17	14.0	17.0	7.5	5.7	22.5	28.0
* C1N3/8-NPT3/8	3/8	NPT3/8	31.7	13.0	4.6	17	17.0	17.0	9.0	5.7	22.5	39.0
* C1N1/2-NPT1/4	1/2	NPT1/4	31.8	12.0	4.6	18	17.0	19.0	8.2	8.2	45.0	33.0
* C1N1/2-NPT3/8	1/2	NPT3/8	32.8	13.0	4.6	18	17.0	19.0	9.0	8.2	45.0	40.0
* C1N1/2-NPT1/2	1/2	NPT1/2	40.8	18.0	4.6	18	23.0	19.0	12.0	8.2	45.0	72.0

*Made to order

90 degree elbow (NPT thread)

●Inch size type (Group 1) NPT thread

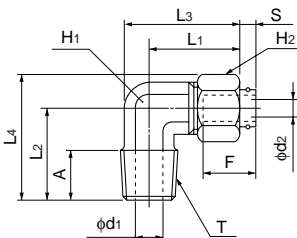

Product number	Applicable tube outer diameter (inch)	T Thread size (NPT)	L ₁ (mm)	L ₂ (mm)	L ₃ (mm)	L ₄ (mm)	A (mm)	S (mm)	F Tube insertion length (mm)	H ₁ Width across flat (mm)	H ₂ Width across flat (mm)	d ₁ (mm)	Min. inner diameter (mm)	Effective cross-sectional area (mm ²)	Weight (g)
* L1N3/16-NPT1/8	3/16	NPT1/8	20.6	18.5	26.3	24.3	11.0	4.6	15	10.0	10.0	5.0	2.4	4.0	18.0
* L1N1/4-NPT1/8	1/4	NPT1/8	20.5	18.5	26.3	25.4	11.0	4.6	15	10.0	12.0	5.0	3.4	8.0	20.0
* L1N1/4-NPT1/4	1/4	NPT1/4	23.0	22.0	29.8	28.9	12.0	4.6	15	10.0	12.0	7.0	3.4	8.0	26.0
* L1N5/16N-PT1/8	5/16	NPT1/8	22.8	21.0	29.8	29.1	11.0	4.6	16	12.0	14.0	5.0	4.7	15.0	30.0
* L1N5/16-NPT1/4	5/16	NPT1/4	22.8	22.0	29.8	30.1	12.0	4.6	16	12.0	14.0	7.0	4.7	15.0	32.0
* L1N3/8-NPT1/4	3/8	NPT1/4	23.7	22.0	30.6	31.8	12.0	4.6	17	12.0	17.0	7.0	5.7	19.0	50.0
* L1N3/8-NPT3/8	3/8	NPT3/8	26.7	26.0	35.2	35.8	13.0	4.6	17	12.0	17.0	7.0	5.7	19.0	50.0
* L1N1/2-NPT1/4	1/2	NPT1/4	27.8	25.0	35.9	36.0	13.5	4.6	18	14.0	19.0	7.0	8.2	32.0	50.0
* L1N1/2-NPT3/8	1/2	NPT3/8	27.8	26.0	36.3	37.0	13.0	4.6	18	14.0	19.0	9.0	8.2	32.0	53.0
* L1N1/2-NPT1/2	1/2	NPT1/2	30.8	33.0	41.6	44.0	18.0	4.6	18	14.0	19.0	10.0	8.2	32.0	76.0

*Made to order

Tube
Clean tube
Processed tube
PushOne fitting
QuickSeal fitting
Clean fitting/ Chemifit
Bamboo-shoot fitting
Control switch/ Detachable series
Jig/Tool/ Accessory
Technical information
Reference

Reference

Technical
information

Jig/Tool/
Accessory

Control switch/
Detachable
series

Bambo-
shoot fitting

Clean fitting/
Chemifit

**QuickSeal
fitting**

PushOne
fitting

Processed
tube

Clean tube

Tube

Insertion type (stainless)

Screw-in type for multi-purpose piping (made of SUS304)

Features

- **Screw-in type**
Consisting of three parts: fitting body, nut and sleeve
- **High sealing performance**
The insertion part is integrated with a fitting body with high negative-pressure performance.
- **Made of SUS304 with high corrosion resistance**
- **JIS B 8381-1995 (fittings for pneumatic flexible pipes) compliant**



Cross-sectional structure diagram

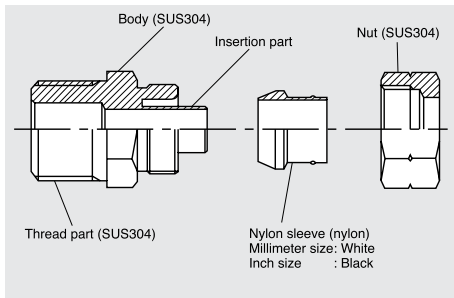

Sealing mechanism

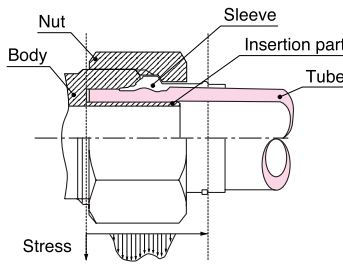

Operating fluid, working temperature range

Operating fluid	Working temperature range
Air	Nylon sleeve -40°C~+80°C
Water	Nylon sleeve 0°C~+70°C
General operating oil	Nylon sleeve -40°C~+80°C

☞ Contact us for various chemical liquids.
☞ See "Combination List of Tube and Fitting" on page 8.

Pressure condition

Maximum working pressure: 5.0MPa
Negative pressure performance: -101.294kPa

Handling instructions

- ⚠ **Caution** When the working conditions of tubes and fittings differ, use them under the lower specified conditions.
 - ⚠ **Caution** For use at a high temperature within the working temperature range, tighten the nut periodically. If the nut cannot be tightened further, cut the tube end and insert the tube again with a new sleeve.
 - ⚠ **Caution** When water is used as the operating fluid, do not allow it to freeze.
 - ⚠ **Caution** Do not bend the pipe sharply near the tube insertion port (sleeve end) of the fitting. Keep the tube straight for twice as long as the tube diameter from the insertion port.
 - ⚠ **Caution** The outer and the inner diameters of the fitting have to be the same as those of the tube used.
- ☞ See page 34 for the common handling instructions for tube fittings.

Product number example

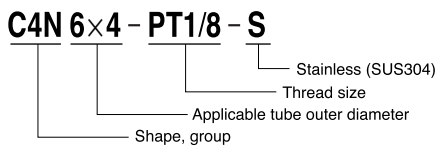







Distinction of millimeter/inch sizes

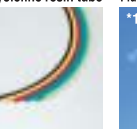
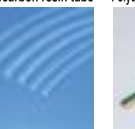

The inch size type has a black sleeve.
The millimeter size type has a cut at the hexagonal nut.

Applicable tube

Polyurethane tube	Nylon tube	Flexible fluorocarbon resin bilayer tube	Polybutene tube	Antistatic tube	Polyolefine resin tube	Fluorocarbon resin tube	Polyurethane processed tube
 U2...P.12 U1...P.13 U5...P.14	 N2...P.15 N5...P.16 N1...P.17	 TES...P.18	 PB...P.25	 UE...P.23	 PL...P.26 PN...P.27	 TA...P.28 TP...P.29	 UC...P.30 USC...P.30 UMC...P.30 UML...P.31

(*1) Combinatory use of PL, PN, TA or TP tube and QuickSeal series of insertion type (stainless) mixes general and clean type performances.
When using them in a clean environment, pay attention to the clean level that could be lowered.

Allied products and product introduction



Reference

- Instruction manual.....P.180
- Chemical resistance specification table.....P.207
- Effective cross-sectional areaP.176
- Negative-pressure performance list.....P.177

Tube

Clean tube

Processed tube

PushOne fitting

QuickSeal fitting

Clean fitting/Chemifit

Bamboo-shoot fitting

Control switch/Detachable series

Jig/Tool/Accessory

Technical information

Reference

QuickSeal Series Insertion type (stainless)

Shape list



- Tube
- Clean tube
- Processed tube
- PushOne fitting
- QuickSeal fitting
- Clean fitting/ Chemifit
- Bamboo-shoot fitting
- Control switch/ Detachable series
- Jig/Tool/ Accessory
- Technical information
- Reference

QuickSeal Series Insertion type (stainless)

Connector

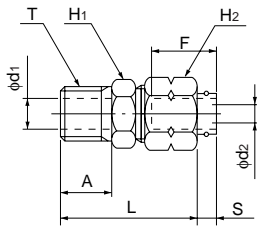

●Millimeter size type (Group 4)

Product number	Applicable tube outer diameter-inner diameter (mm)	T Thread size (R)	L (mm)	A (mm)	S (mm)	F Tube insertion length (mm)	H1 Width across flat (mm)	H2 Width across flat (mm)	d1 (mm)	d2 Min. inner diameter (mm)	Effective cross-sectional area (mm ²)	Weight (g)
C4N6×4-PT1/8-S	6×4	R1/8	28.0	11.0	4.6	15	10.0	12.0	5.0	2.7	5.0	15.0
C4N6×4-PT1/4-S	6×4	R1/4	30.0	12.0	4.6	15	14.0	12.0	7.0	2.7	5.0	22.0
C4N8×5-PT1/8-S	8×5	R1/8	27.9	11.0	4.6	16	12.0	14.0	5.0	3.7	10.0	18.0
C4N8×5-PT1/4-S	8×5	R1/4	29.9	12.0	4.6	16	14.0	14.0	7.0	3.7	10.0	24.0
C4N8×6-PT1/8-S	8×6	R1/8	27.9	11.0	4.6	16	12.0	14.0	5.0	4.7	16.0	17.0
C4N8×6-PT1/4-S	8×6	R1/4	29.9	12.0	4.6	16	14.0	14.0	7.0	4.7	16.0	24.0
C4N10×6.5-PT1/4-S	10×6.5	R1/4	31.1	12.0	4.2	17	17.0	17.0	7.0	5.2	20.5	32.0
C4N10×6.5-PT3/8-S	10×6.5	R3/8	32.1	13.0	4.2	17	17.0	17.0	9.0	5.2	20.5	38.0
C4N10×8-PT1/4-S	10×8	R1/4	31.1	12.0	4.2	17	15.0	17.0	7.0	6.7	32.0	29.0
C4N10×8-PT3/8-S	10×8	R3/8	32.1	13.0	4.2	17	17.0	17.0	9.0	6.7	32.0	37.0
C4N12×8-PT3/8-S	12×8	R3/8	35.6	13.0	4.8	18	17.0	19.0	9.0	6.6	32.0	47.0
C4N12×8-PT1/2-S	12×8	R1/2	40.6	18.0	4.8	18	23.0	19.0	12.0	6.6	33.5	75.0
C4N12×9-PT3/8-S	12×9	R3/8	35.6	13.0	4.8	18	17.0	19.0	9.0	7.6	40.0	40.5
C4N12×9-PT1/2-S	12×9	R1/2	40.6	18.0	4.8	18	23.0	19.0	12.0	7.6	40.0	74.0

●Inch size type (Group 1)

Product number	Applicable tube outer diameter (inch)	T Thread size (R)	L (mm)	A (mm)	S (mm)	F Tube insertion length (mm)	H1 Width across flat (mm)	H2 Width across flat (mm)	d1 (mm)	d2 Min. inner diameter (mm)	Effective cross-sectional area (mm ²)	Weight (g)
C1N1/4-PT1/8-S	1/4	R1/8	28.0	11.0	4.6	15	10.0	12.0	5.0	3.4	8.5	14.0
C1N1/4-PT1/4-S	1/4	R1/4	30.0	12.0	4.6	15	14.0	12.0	7.0	3.4	8.5	22.0
C1N5/16-PT1/8-S	5/16	R1/8	27.8	11.0	4.6	16	12.0	14.0	5.0	4.7	16.0	17.0
C1N5/16-PT1/4-S	5/16	R1/4	29.8	12.0	4.6	16	14.0	14.0	7.0	4.7	16.0	24.0
C1N3/8-PT1/8-S	3/8	R1/8	28.7	11.0	4.6	17	14.0	17.0	5.7	5.7	22.5	23.0
C1N3/8-PT1/4-S	3/8	R1/4	30.7	12.0	4.6	17	14.0	17.0	7.5	5.7	22.5	28.0
C1N3/8-PT3/8-S	3/8	R3/8	31.7	13.0	4.6	17	17.0	17.0	9.0	5.7	22.5	39.0
C1N1/2-PT1/4-S	1/2	R1/4	31.8	12.0	4.6	18	17.0	19.0	8.2	8.2	45.0	33.0
C1N1/2-PT3/8-S	1/2	R3/8	32.8	13.0	4.6	18	17.0	19.0	9.0	8.2	45.0	40.0
C1N1/2-PT1/2-S	1/2	R1/2	40.8	18.0	4.6	18	23.0	19.0	12.0	8.2	45.0	72.0

90 degree elbow

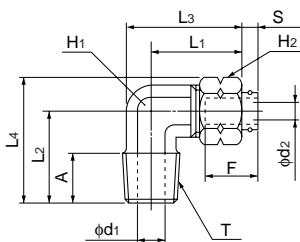

●Millimeter size type (Group 4)

Product number	Applicable tube outer diameter-inner diameter (mm)	T Thread size (R)	L1 (mm)	L2 (mm)	L3 (mm)	L4 (mm)	A (mm)	S (mm)	F Tube insertion length (mm)	H1 Width across flat (mm)	H2 Width across flat (mm)	d1 (mm)	d2 Min. inner diameter (mm)	Effective cross-sectional area (mm ²)	Weight (g)
L4N6×4-PT1/8-S	6×4	R1/8	20.5	18.5	26.3	25.4	11.0	4.6	15	10.0	12.0	5.0	2.7	4.5	21.0
L4N6×4-PT1/4-S	6×4	R1/4	23.0	22.0	29.9	28.9	12.0	4.6	15	12.0	12.0	7.0	2.7	4.5	32.0
L4N8×5-PT1/8-S	8×5	R1/8	22.9	21.0	29.8	29.1	11.0	4.6	16	12.0	14.0	5.0	3.7	9.0	31.0
L4N8×5-PT1/4-S	8×5	R1/4	22.9	22.0	29.8	30.1	12.0	4.6	16	12.0	14.0	7.0	3.7	9.0	32.5
L4N8×6-PT1/8-S	8×6	R1/8	22.9	21.0	29.8	29.1	11.0	4.6	16	12.0	14.0	5.0	4.7	14.0	31.0
L4N8×6-PT1/4-S	8×6	R1/4	22.9	22.0	29.8	30.1	12.0	4.6	16	12.0	14.0	7.0	4.7	15.0	32.5
L4N10×6.5-PT1/4-S	10×6.5	R1/4	27.1	25.0	35.2	34.8	13.5	4.2	17	14.0	17.0	7.0	5.2	18.0	47.0
L4N10×6.5-PT3/8-S	10×6.5	R3/8	27.1	26.0	35.2	35.8	13.0	4.2	17	14.0	17.0	9.0	5.2	18.0	50.0
L4N10×8-PT1/4-S	10×8	R1/4	27.1	25.0	35.2	34.8	13.5	4.2	17	14.0	17.0	7.0	6.7	25.0	48.0
L4N10×8-PT3/8-S	10×8	R3/8	27.1	26.0	35.2	35.8	13.0	4.2	17	14.0	17.0	9.0	6.7	25.0	51.0
L4N12×8-PT3/8-S	12×8	R3/8	27.6	26.0	35.7	37.0	13.0	4.8	18	18.0	19.0	9.0	6.6	25.0	53.0
L4N12×8-PT1/2-S	12×8	R1/2	30.1	33.0	40.9	44.0	18.0	4.8	18	14.0	19.0	10.0	6.6	30.0	90.0
L4N12×9-PT3/8-S	12×9	R3/8	27.6	26.0	35.7	37.0	13.0	4.8	18	14.0	19.0	9.0	7.6	33.0	54.0
L4N12×9-PT1/2-S	12×9	R1/2	30.6	33.0	41.4	44.0	18.0	4.8	18	14.0	19.0	10.0	7.6	33.0	91.0

●Inch size type (Group 1)

Product number	Applicable tube outer diameter (inch)	T Thread size (R)	L1 (mm)	L2 (mm)	L3 (mm)	L4 (mm)	A (mm)	S (mm)	F Tube insertion length (mm)	H1 Width across flat (mm)	H2 Width across flat (mm)	d1 (mm)	d2 Min. inner diameter (mm)	Effective cross-sectional area (mm ²)	Weight (g)
L1N1/4-PT1/8-S	1/4	R1/8	20.5	18.5	26.3	25.4	11.0	4.6	15	10.0	12.0	5.0	3.4	8.0	20.0
L1N1/4-PT1/4-S	1/4	R1/4	23.0	22.0	29.8	28.9	12.0	4.6	15	12.0	12.0	7.0	3.4	8.0	26.0
L1N5/16-PT1/8-S	5/16	R1/8	22.8	21.0	29.8	29.1	11.0	4.6	16	12.0	14.0	5.0	4.7	15.0	30.0
L1N5/16-PT1/4-S	5/16	R1/4	22.8	22.0	29.8	30.1	12.0	4.6	16	12.0	14.0	7.0	4.7	15.0	32.0
L1N3/8-PT1/8-S	3/8	R1/8	23.7	21.0	30.6	30.8	11.0	4.6	17	12.0	17.0	5.0	5.7	15.0	35.0
L1N3/8-PT1/4-S	3/8	R1/4	23.7	22.0	30.6	31.8	12.0	4.6	17	12.0	17.0	7.0	5.7	19.0	50.0
L1N3/8-PT3/8-S	3/8	R3/8	26.7	26.0	35.2	35.8	13.0	4.6	17	14.0	17.0	7.0	5.7	19.0	50.0
L1N1/2-PT1/4-S	1/2	R1/4	27.8	25.0	35.9	36.0	13.5	4.6	18	14.0	19.0	7.0	8.2	32.0	50.0
L1N1/2-PT3/8-S	1/2	R3/8	27.8	26.0	36.3	37.0	13.0	4.6	18	14.0	19.0	9.0	8.2	32.0	53.0
L1N1/2-PT1/2-S	1/2	R1/2	30.8	33.0	41.6	44.0	18.0	4.6	18	18.0	19.0	12.0	8.2	32.0	76.0

Tee

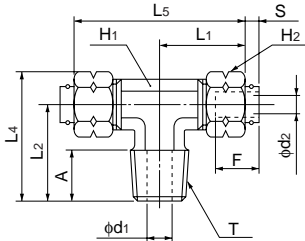

●Millimeter size type (Group 4)

Product number	Applicable tube outer diameter- inner diameter (mm)	T Thread size (R)	L1 (mm)	L2 (mm)	L4 (mm)	L5 (mm)	A (mm)	S (mm)	F Tube insertion length (mm)	H1 Width across flat (mm)	H2 Width across flat (mm)	d1 (mm)	d2 Min. inner diameter (mm)	Effective cross-sectional area (mm ²)	Weight (g)
T4N6×4-PT1/8-S	6×4	R1/8	20.5	18.5	25.4	41.0	11.0	4.6	15	10.0	12.0	5.0	2.7	4.5	30.0
T4N6×4-PT1/4-S	6×4	R1/4	23.0	22.0	28.9	46.0	12.0	4.6	15	12.0	12.0	7.0	2.7	4.5	43.0
T4N8×5-PT1/8-S	8×5	R1/8	22.9	21.0	29.1	45.8	11.0	4.6	16	12.0	14.0	5.0	3.7	9.0	43.0
T4N8×5-PT1/4-S	8×5	R1/4	22.9	22.0	30.1	45.8	12.0	4.6	16	12.0	14.0	7.0	3.7	9.0	45.0
T4N8×6-PT1/8-S	8×6	R1/8	22.9	21.0	29.1	45.8	11.0	4.6	16	12.0	14.0	5.0	4.7	14.0	42.0
T4N8×6-PT1/4-S	8×6	R1/4	22.9	22.0	30.1	45.8	12.0	4.6	16	12.0	14.0	7.0	4.7	15.0	44.0
T4N10×6.5-PT1/4-S	10×6.5	R1/4	27.1	25.0	34.8	54.2	12.0	4.2	17	14.0	17.0	7.0	5.2	18.0	73.0
T4N10×6.5-PT3/8-S	10×6.5	R3/8	28.1	26.0	35.8	56.2	13.0	4.2	17	14.0	17.0	9.0	5.2	18.0	78.0
T4N10×8-PT1/4-S	10×8	R1/4	27.1	25.0	34.8	54.2	12.0	4.2	17	14.0	17.0	7.0	6.7	25.0	69.0
T4N10×8-PT3/8-S	10×8	R3/8	27.1	26.0	35.8	54.2	13.0	4.2	17	14.0	17.0	9.0	6.7	25.0	75.0
T4N12×8-PT3/8-S	12×8	R3/8	27.6	25.0	36.0	55.3	13.0	4.2	18	14.0	19.0	9.0	6.6	25.0	82.0
T4N12×9-PT3/8-S	12×9	R3/8	27.6	26.0	37.0	55.3	13.0	4.8	18	14.0	19.0	9.0	7.6	33.0	82.0

●Inch size type (Group 1)

Product number	Applicable tube outer diameter (inch)	T Thread size (R)	L1 (mm)	L2 (mm)	L4 (mm)	L5 (mm)	A (mm)	S (mm)	F Tube insertion length (mm)	H1 Width across flat (mm)	H2 Width across flat (mm)	d1 (mm)	d2 Min. inner diameter (mm)	Effective cross-sectional area (mm ²)	Weight (g)
T1N1/4-PT1/8-S	1/4	R1/8	20.5	18.5	25.4	41.1	11.0	4.6	15	10.0	12.0	5.0	3.4	8.0	29.0
T1N1/4-PT1/4-S	1/4	R1/4	23.0	22.0	28.9	46.1	12.0	4.6	15	12.0	12.0	7.0	3.4	8.0	42.0
T1N3/8-PT1/4-S	3/8	R1/4	23.7	22.0	31.8	47.4	12.0	4.6	17	12.0	17.0	7.0	5.7	19.0	55.0

Service tee

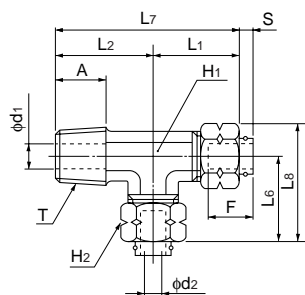

●Millimeter size type (Group 4)

Product number	Applicable tube outer diameter- inner diameter (mm)	T Thread size (R)	L1 (mm)	L2 (mm)	L6 (mm)	L7 (mm)	L8 (mm)	A (mm)	S (mm)	F Tube insertion length (mm)	H1 Width across flat (mm)	H2 Width across flat (mm)	d1 (mm)	d2 Min. inner diameter (mm)	Effective cross-sectional area (mm ²)	Weight (g)
ST4N6×4-PT1/8-S	6×4	R1/8	20.5	18.5	20.5	39.0	27.4	11.0	4.6	15	10.0	12.0	5.0	2.7	4.5	41.0
ST4N6×4-PT1/4-S	6×4	R1/4	23.0	22.0	23.0	45.0	29.9	12.0	4.6	15	12.0	12.0	7.0	2.7	4.5	30.0
ST4N8×5-PT1/8-S	8×5	R1/8	22.9	21.0	22.9	43.9	31.0	11.0	4.6	16	12.0	14.0	5.0	3.7	9.0	43.0
ST4N8×5-PT1/4-S	8×5	R1/4	22.9	22.0	22.9	44.9	31.0	12.0	4.6	16	12.0	14.0	7.0	3.7	9.0	43.0
ST4N8×6-PT1/8-S	8×6	R1/8	22.9	21.0	22.9	43.9	31.0	11.0	4.6	16	12.0	14.0	5.0	4.7	14.0	45.0
ST4N8×6-PT1/4-S	8×6	R1/4	22.9	22.0	22.9	44.9	31.0	12.0	4.6	16	12.0	14.0	7.0	4.7	15.0	46.0
ST4N10×6.5-PT1/4-S	10×6.5	R1/4	27.1	25.0	27.1	52.1	36.9	12.0	4.2	17	14.0	17.0	7.0	5.2	18.0	72.0
ST4N10×6.5-PT3/8-S	10×6.5	R3/8	27.1	26.0	27.1	53.1	36.9	13.0	4.2	17	14.0	17.0	9.0	5.2	18.0	70.0
ST4N10×8-PT1/4-S	10×8	R1/4	27.1	25.0	27.1	52.1	36.9	12.0	4.2	17	14.0	17.0	7.0	6.7	25.0	76.0
ST4N10×8-PT3/8-S	10×8	R3/8	27.1	26.0	27.1	53.1	36.9	13.0	4.2	17	14.0	17.0	9.0	6.7	25.0	113.0
ST4N12×8-PT3/8-S	12×8	R3/8	27.6	26.0	27.6	53.6	38.6	13.0	4.8	18	14.0	19.0	9.0	6.6	25.0	81.0
ST4N12×9-PT3/8-S	12×9	R3/8	27.6	26.0	27.6	53.6	38.6	13.0	4.8	18	14.0	19.0	9.0	7.6	33.0	130.0

●Inch size type (Group 1)

Product number	Applicable tube outer diameter (inch)	T Thread size (R)	L1 (mm)	L2 (mm)	L6 (mm)	L7 (mm)	L8 (mm)	A (mm)	S (mm)	F Tube insertion length (mm)	H1 Width across flat (mm)	H2 Width across flat (mm)	d1 (mm)	d2 Min. inner diameter (mm)	Effective cross-sectional area (mm ²)	Weight (g)
ST1N1/4-PT1/8-S	1/4	R1/8	20.5	18.5	20.5	39.0	27.5	11.0	4.6	15	10.0	12.0	5.0	3.4	8.0	29.0

Tube

Clean tube

Processed tube

PushOne fitting

QuickSeal fitting

Clean fitting/ Chemifit

Bamboo-shoot fitting

Control switch/ Detachable series

Jig/Tool/ Accessory

Technical information

Reference

QuickSeal Series Insertion type (stainless)

Union connector

●Millimeter size type (Group 4)

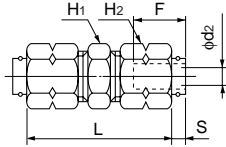

Product number	Applicable tube outer diameter:inner diameter (mm)	L (mm)	S (mm)	F Tube insertion length (mm)	H1 Width across flat (mm)	H2 Width across flat (mm)	d2 Min. inner diameter (mm)	Effective cross-sectional area (mm ²)	Weight (g)
UC4N6×4-S	6×4	33.0	4.6	15	10.0	12.0	2.7	5.0	20.0
UC4N8×5-S	8×5	32.8	4.6	16	12.0	14.0	3.7	10.0	28.0
UC4N8×6-S	8×6	32.8	4.6	16	12.0	14.0	4.7	16.0	25.0
UC4N10×6.5-S	10×6.5	36.2	4.2	17	17.0	17.0	5.2	20.5	44.0
UC4N10×8-S	10×8	36.2	4.2	17	17.0	17.0	6.7	32.0	44.0
UC4N12×8-S	12×8	37.3	4.8	18	17.0	19.0	6.6	32.0	49.0
UC4N12×9-S	12×9	37.3	4.8	18	17.0	19.0	7.6	40.0	51.0

●Inch size type (Group 1)

Product number	Applicable tube outer diameter (inch)	L (mm)	S (mm)	F Tube insertion length (mm)	H1 Width across flat (mm)	H2 Width across flat (mm)	d2 Min. inner diameter (mm)	Effective cross-sectional area (mm ²)	Weight (g)
UC1N1/4-S	1/4	33.1	4.6	15	10.0	12.0	3.4	8.5	20.0
UC1N5/16-S	5/16	32.7	4.6	16	12.0	14.0	4.7	16.0	25.0
UC1N3/8-S	3/8	35.4	4.6	17	14.0	17.0	5.7	22.5	40.0
UC1N1/2-S	1/2	37.6	4.6	18	17.0	19.0	8.2	45.0	47.0

90 degree union elbow

●Millimeter size type (Group 4)

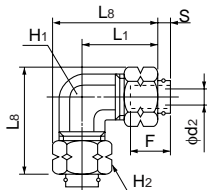

Product number	Applicable tube outer diameter:inner diameter (mm)	L1 (mm)	L8 (mm)	S (mm)	F Tube insertion length (mm)	H1 Width across flat (mm)	H2 Width across flat (mm)	d2 Min. inner diameter (mm)	Effective cross-sectional area (mm ²)	Weight (g)
UL4N6×4-S	6×4	20.5	27.4	4.6	15	10.0	12.0	2.7	4.0	25.0
UL4N8×5-S	8×5	22.9	31.0	4.6	16	12.0	14.0	3.7	7.5	37.0
UL4N8×6-S	8×6	22.9	31.0	4.6	16	12.0	14.0	4.7	12.5	36.0
UL4N10×6.5-S	10×6.5	27.1	36.9	4.2	17	14.0	17.0	5.2	15.5	59.0
UL4N10×8-S	10×8	27.1	36.9	4.2	17	14.0	17.0	6.7	25.0	57.0
UL4N12×8-S	12×8	27.6	38.6	4.8	18	14.0	19.0	6.6	25.0	63.0
UL4N12×9-S	12×9	27.6	38.6	4.8	18	14.0	19.0	7.6	25.0	60.0

Union tee

●Millimeter size type (Group 4)

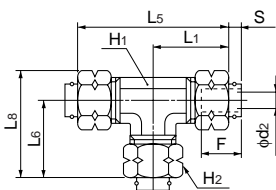

Product number	Applicable tube outer diameter:inner diameter (mm)	L1 (mm)	L5 (mm)	L6 (mm)	L8 (mm)	S (mm)	F Tube insertion length (mm)	H1 Width across flat (mm)	H2 Width across flat (mm)	d2 Min. inner diameter (mm)	Effective cross-sectional area (mm ²)	Weight (g)
UT4N6×4-S	6×4	20.5	41.0	20.5	27.4	4.6	15	10.0	12.0	2.7	4.0	35.0
UT4N8×5-S	8×5	22.9	45.8	22.9	31.0	4.6	16	12.0	14.0	3.7	7.5	49.0
UT4N8×6-S	8×6	22.9	45.8	22.9	31.0	4.6	16	12.0	14.0	4.7	12.5	48.0
UT4N10×6.5-S	10×6.5	27.1	54.2	27.1	36.9	4.2	17	14.0	17.0	5.2	15.5	82.0
UT4N10×8-S	10×8	27.1	54.2	27.1	36.9	4.2	17	14.0	17.0	6.7	25.0	77.0
UT4N12×8-S	12×8	27.6	55.3	27.6	38.6	4.8	18	14.0	19.0	6.6	25.0	90.0
UT4N12×9-S	12×9	27.6	55.3	27.6	38.6	4.8	18	14.0	19.0	7.6	25.0	85.0

●Inch size type (Group 1)

Product number	Applicable tube outer diameter (inch)	L1 (mm)	L5 (mm)	L6 (mm)	L8 (mm)	S (mm)	F Tube insertion length (mm)	H1 Width across flat (mm)	H2 Width across flat (mm)	d2 Min. inner diameter (mm)	Effective cross-sectional area (mm ²)	Weight (g)
UT1N1/4-S	1/4	20.5	41.1	20.5	27.5	4.6	15	10.0	12.0	3.4	6.5	34.0
UT1N5/16-S	5/16	22.8	45.7	22.8	30.9	4.6	16	12.0	14.0	4.7	12.5	49.0
UT1N3/8-S	3/8	23.7	47.4	23.7	33.5	4.6	17	12.0	17.0	5.7	18.5	64.0
*UT1N1/2-S	1/2	27.8	55.6	27.8	38.8	4.6	18	14.0	19.0	8.2	30.0	84.0

*Made to order

Tube

Clean tube

Processed tube

PushOne fitting

QuickSeal fitting

Clean fitting/ Chemifit

Bamboo-shoot fitting

Control switch/ Detachable series

Jig/Tool/ Accessory

Technical information

Reference

Stainless nut

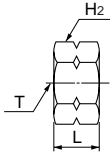

*The inch size type has no cut.

●Millimeter size type (Group 4)

Product number	Applicable tube outer diameter (mm)	T Thread size (M)	L (mm)	H ₂ Width across flat (mm)	Weight (g)
N6-S	6	M10×1.0	9.0	12.0	5.0
N8-S	8	M12×1.0	9.0	14.0	6.0
N10-S	10	M15×1.0	10.0	17.0	9.0
N12-S	12	M17×1.0	11.0	19.0	11.0

●Inch size type (Group 1)

Product number	Applicable tube outer diameter (inch)	T Thread size (M)	L (mm)	H ₂ Width across flat (mm)	Weight (g)
N1/4-S	1/4	M10×1.0	9.0	12.0	5.0
N5/16-S	5/16	M12×1.0	9.0	14.0	6.0
N3/8-S	3/8	M14×1.0	10.0	17.0	10.0
N1/2-S	1/2	M17×1.0	11.5	19.0	11.0

Nylon sleeve

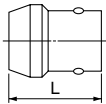

●Millimeter size type (Color: milky white)

Product number	Applicable tube outer diameter (mm)	L (mm)
SN6	6	11.0
SN8	8	11.0
SN10	10	12.0
SN12	12	13.0

●Inch size type (Color: black)

Product number	Applicable tube outer diameter (inch)	L (mm)
SN1/4	1/4	11.0
SN5/16	5/16	11.0
SN3/8	3/8	12.0
SN1/2	1/2	13.0

Tube

Clean tube

Processed tube

PushOne fitting

QuickSeal fitting

Clean fitting/Chemifit

Bambooshoot fitting

Control switch/Detachable series

Jig/Tool/Accessory

Technical information

Reference

Insertless type

Screw-in type for general pneumatic piping

Features

- **Screw-in type**
Consisting of three parts: fitting body, nut and sleeve
- **Large flow volume**
Large effective cross sectional area due to lack of an insertion part.
- **Only the connector is sealed.**
Sealing tape is not required.



Cross-sectional structure diagram

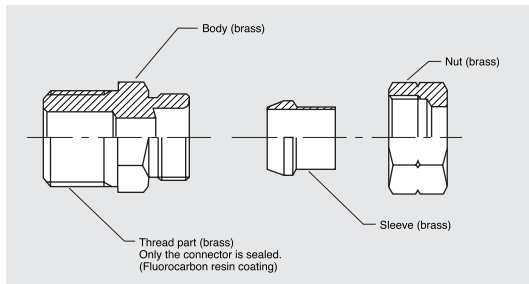

Product number example

4A01 - 2420

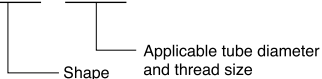

Applicable tube

Nylon tube



N2•••P.15
N5•••P.16
N1•••P.17

Operating fluid, working temperature range

Operating fluid	Working temperature range
Air	-40°C~+100°C

See "Combination List of Tube and Fitting" on page 8.

Pressure condition

Maximum working pressure: 1.0MPa
Negative pressure performance:
-99.975kPa

Handling instructions

- ⚠ **Caution** When the working conditions of tubes and fittings differ, use them under the lower specified conditions.
- ⚠ **Caution** For use at a high temperature within the working temperature range, tighten the nut periodically. If the nut cannot be tightened further, cut the tube end and insert the tube again with a new sleeve.
- ⚠ **Caution** Do not bend the pipe sharply near the tube insertion port (sleeve end) of the fitting. Keep the tube straight for twice as long as the tube diameter from the insertion port.

See page 34 for the common handling instructions for tube fittings.

Reference

Instruction manual.....P.180
Effective cross-sectional area.....P.176
Negative-pressure performance list..P.177

QuickSeal Series Insertless type (brass)

Shape list

Connector 4A01  P.95	90 degree elbow 4A02  P.95	Tee 4A03  P.96	Service tee 4A04  P.96	Union tee 4A05  P.96
Swivel nut internal connector 4A06  P.96	Union connector 4A07  P.97	90 degree union elbow 4A08  P.97	Brass nut N  P.97	Brass sleeve MSN  P.97

Connector

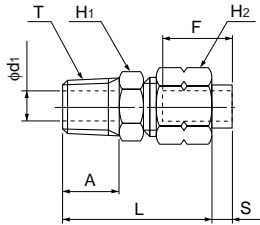

●Millimeter size type

Product number	Applicable tube outer diameter (mm)	T Thread size (R)	L (mm)	A (mm)	S (mm)	F Tube insertion length (mm)	H ₁ Width across flat (mm)	H ₂ Width across flat (mm)	d ₁ (mm)	Min. inner diameter (mm)	Effective cross-sectional area (mm ²)	Weight (g)
4A01-2402	4	R1/8	27.9	11.0	2.7	14	10.0	10.0	5.0	2.0	3.0	13.0
4A01-2602	6	R1/8	27.9	11.0	2.6	14	10.0	12.0	5.0	4.0	10.0	15.0
4A01-2604	6	R1/4	29.9	12.0	2.6	14	14.0	12.0	7.0	4.0	10.0	23.0
4A01-2802	8	R1/8	27.8	11.0	2.6	15	12.0	14.0	5.0	5.0	18.0	17.0
4A01-2804	8	R1/4	29.8	12.0	2.6	15	14.0	14.0	7.0	6.0	25.0	24.0
4A01-3004	10	R1/4	31.0	12.0	2.3	18	17.0	17.0	7.5	7.5	39.0	31.0
4A01-3006	10	R3/8	32.0	13.0	2.3	18	17.0	17.0	9.0	7.5	39.0	38.0
4A01-3206	12	R3/8	32.5	13.0	3.1	19	17.0	19.0	9.0	8.0	45.0	40.0
4A01-3208	12	R1/2	40.5	18.0	3.1	19	24.0	19.0	12.0	8.0	45.0	71.0

☞ Only the connector is sealed.

90 degree elbow

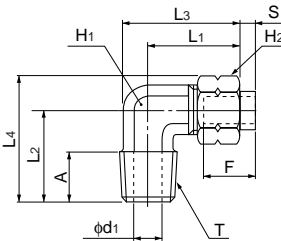

●Millimeter size type

Product number	Applicable tube outer diameter (mm)	T Thread size (R)	L ₁ (mm)	L ₂ (mm)	L ₃ (mm)	L ₄ (mm)	A (mm)	S (mm)	F Tube insertion length (mm)	H ₁ Width across flat (mm)	H ₂ Width across flat (mm)	d ₁ (mm)	Min. inner diameter (mm)	Effective cross-sectional area (mm ²)	Weight (g)
4A02-2402	4	R1/8	20.4	18.5	26.2	24.3	11.0	2.7	14	10.0	10.0	5.0	2.0	3.0	19.0
4A02-2602	6	R1/8	20.4	18.5	26.2	25.4	11.0	2.6	14	10.0	12.0	5.0	4.0	9.0	20.0
4A02-2604	6	R1/4	22.9	22.0	29.9	28.9	12.0	2.6	14	12.0	12.0	7.0	4.0	10.0	30.0
4A02-2802	8	R1/8	22.8	21.0	29.8	29.1	11.0	2.6	15	12.0	14.0	5.0	5.0	16.0	29.0
4A02-2804	8	R1/4	22.8	22.0	29.8	30.1	12.0	2.6	15	12.0	14.0	7.0	6.0	22.0	32.0
4A02-3004	10	R1/4	27.0	25.0	35.1	34.8	13.5	2.3	18	14.0	17.0	7.0	7.0	30.0	46.0
4A02-3006	10	R3/8	27.0	26.0	35.5	35.8	13.0	2.3	18	14.0	17.0	9.0	7.5	35.0	82.0
4A02-3206	12	R3/8	27.5	26.0	36.0	37.0	13.0	3.1	19	14.0	19.0	9.0	8.0	40.0	53.0
4A02-3208	12	R1/2	30.0	33.0	40.8	44.0	18.0	3.1	19	14.0	19.0	10.0	8.0	40.0	90.0

Tee

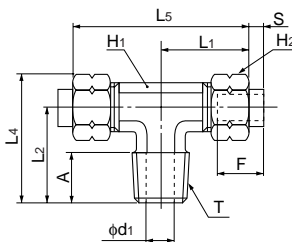

●Millimeter size type

Product number	Applicable tube outer diameter (mm)	T Thread size (R)	L ₁ (mm)	L ₂ (mm)	L ₄ (mm)	L ₅ (mm)	A (mm)	S (mm)	F Tube insertion length (mm)	H ₁ Width across flat (mm)	H ₂ Width across flat (mm)	d ₁ (mm)	Min. inner diameter (mm)	Effective cross-sectional area (mm ²)	Weight (g)
4A03-2402	4	R1/8	20.4	18.5	24.3	40.8	11.0	2.7	14	10.0	10.0	5.0	2.0	3.0	27.0
4A03-2602	6	R1/8	20.4	18.5	25.4	40.8	11.0	2.6	14	10.0	12.0	5.0	4.0	9.0	29.0
4A03-2604	6	R1/4	22.9	22.0	28.9	45.8	12.0	2.6	14	12.0	12.0	7.0	4.0	10.0	43.0
4A03-2802	8	R1/8	22.8	21.0	29.1	45.7	11.0	2.6	15	12.0	14.0	5.0	5.0	16.0	42.0
4A03-2804	8	R1/4	22.8	22.0	30.1	45.7	12.0	2.6	15	12.0	14.0	7.0	6.0	22.0	43.0
4A03-3004	10	R1/4	27.0	25.0	34.8	53.9	12.0	2.3	18	14.0	17.0	7.0	7.0	30.0	69.0
4A03-3006	10	R3/8	27.0	26.0	35.8	53.9	13.0	2.3	18	14.0	17.0	9.0	7.5	35.0	73.0
4A03-3206	12	R3/8	27.5	26.0	37.0	54.9	13.0	3.1	19	14.0	19.0	9.0	8.0	40.0	79.0
4A03-3208	12	R1/2	30.5	33.0	44.0	60.9	18.0	3.1	19	18.0	19.0	12.0	8.0	40.0	125.0

Tube

Clean tube

Processed tube

PushOne fitting

QuickSeal fitting

Clean fitting/Chemit

Bamboo-shoot fitting

Control switch/Detachable series

Jig/Tool/Accessory

Technical information

Reference

Service tee

●Millimeter size type

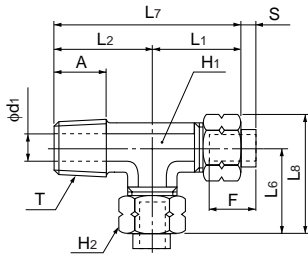

Product number	Applicable tube outer diameter (mm)	T Thread size (R)	L ₁ (mm)	L ₂ (mm)	L ₆ (mm)	L ₇ (mm)	L ₈ (mm)	A (mm)	S (mm)	F Tube insertion length (mm)	H ₁ Width across flat (mm)	H ₂ Width across flat (mm)	d ₁ (mm)	Min. inner diameter (mm)	Effective cross-sectional area (mm ²)	Weight (g)
* 4A04-2402	4	R1/8	20.4	18.5	20.4	38.9	26.2	11.0	2.7	14	10.0	10.0	5.0	2.0	3.0	27.0
4A04-2602	6	R1/8	20.4	18.5	20.4	38.9	27.4	11.0	2.6	14	10.0	12.0	5.0	4.0	9.0	29.0
4A04-2604	6	R1/4	22.9	22.0	22.9	44.9	29.9	12.0	2.6	14	12.0	12.0	7.0	4.0	10.0	37.0
4A04-2802	8	R1/8	22.8	21.0	22.8	43.8	30.9	11.0	2.6	15	12.0	14.0	5.0	5.0	16.0	41.0
4A04-2804	8	R1/4	22.8	22.0	22.8	44.8	30.9	12.0	2.6	15	12.0	14.0	7.0	6.0	22.0	43.0
* 4A04-3004	10	R1/4	27.0	25.0	27.0	52.0	36.8	12.0	2.3	18	14.0	17.0	7.0	7.0	30.0	70.0
* 4A04-3006	10	R3/8	27.0	26.0	27.0	53.0	36.8	13.0	2.3	18	14.0	17.0	9.0	7.5	35.0	73.0
* 4A04-3206	12	R3/8	27.5	26.0	27.5	53.5	38.4	13.0	3.1	19	14.0	19.0	9.0	8.0	40.0	80.0
* 4A04-3208	12	R1/2	30.5	35.5	30.5	66.0	41.4	18.0	3.1	19	18.0	19.0	12.0	8.0	40.0	127.0

*Made to order

Union tee

●Millimeter size type

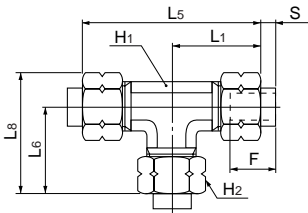

Product number	Applicable tube outer diameter (mm)	L ₁ (mm)	L ₅ (mm)	L ₆ (mm)	L ₈ (mm)	S (mm)	F Tube insertion length (mm)	H ₁ Width across flat (mm)	H ₂ Width across flat (mm)	Min. inner diameter (mm)	Effective cross-sectional area (mm ²)	Weight (g)
4A05-2400	4	20.4	40.8	20.4	26.2	2.7	14	10.0	10.0	2.0	3.0	30.0
4A05-2600	6	20.4	40.8	20.4	27.4	2.6	14	10.0	12.0	4.0	8.0	34.0
4A05-2800	8	22.8	45.7	22.8	30.9	2.6	15	12.0	14.0	6.0	20.0	45.0
4A05-3000	10	27.0	53.9	27.0	36.8	2.3	18	14.0	17.0	7.5	31.0	74.0
4A05-3200	12	27.5	54.9	27.5	38.4	3.1	19	14.0	19.0	8.0	37.0	85.0

Swivel nut internal connector

●Millimeter size type

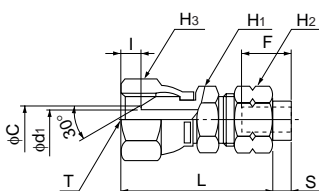

Product number	Applicable tube outer diameter (mm)	T Thread size (G)	L (mm)	S (mm)	I (mm)	F Tube insertion length (mm)	H ₁ Width across flat (mm)	H ₂ Width across flat (mm)	H ₃ Width across flat (mm)	C (mm)	d ₁ (mm)	Min. inner diameter (mm)	Effective cross-sectional area (mm ²)	Weight (g)
* 4A06-2402	4	G1/8	32.9	2.7	4.0	14	12.0	10.0	14.0	5.0	3.0	3.0	3.5	24.0
* 4A06-2602	6	G1/8	32.9	2.6	4.0	14	12.0	12.0	14.0	5.0	3.0	3.0	6.5	25.0
4A06-2604	6	G1/4	34.6	2.6	5.7	14	17.0	12.0	19.0	7.0	5.0	5.0	10.0	43.0
4A06-2804	8	G1/4	34.5	2.6	5.7	18	17.0	14.0	19.0	7.0	5.0	5.0	18.0	45.0
* 4A06-3006	10	G3/8	40.8	2.3	6.8	18	19.0	17.0	22.0	10.0	8.0	8.0	42.0	75.0
* 4A06-3206	12	G3/8	41.3	3.1	6.8	19	19.0	19.0	22.0	10.0	8.0	8.0	45.0	67.0
* 4A06-3208	12	G1/2	46.0	3.1	9.5	19	22.0	19.0	27.0	14.0	10.0	10.0	54.0	115.0

*Made to order

Tube
Clean tube
Processed tube
PushOne fitting
QuickSeal fitting
Clean fitting/Chemifit
Bamboo-shoot fitting
Control switch/Detachable series
Jig/Tool/Accessory
Technical information
Reference

Union connector

●Millimeter size type

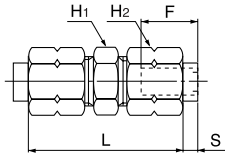

Product number	Applicable tube outer diameter (mm)	L (mm)	S (mm)	F Tube insertion length (mm)	H1 Width across flat (mm)	H2 Width across flat (mm)	Min. inner diameter (mm)	Effective cross-sectional area (mm ²)	Weight (g)
4A07-2400	4	32.8	2.7	14	8.0	10.0	2.0	3.0	15.0
4A07-2600	6	32.8	2.6	14	10.0	12.0	4.0	10.0	20.0
4A07-2800	8	32.7	2.6	15	14.0	14.0	6.0	25.0	27.0
4A07-3000	10	35.9	2.3	18	17.0	17.0	7.5	39.0	42.0
4A07-3200	12	36.9	3.1	19	17.0	19.0	8.0	45.0	48.0

90 degree union elbow

●Millimeter size type

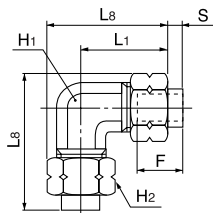

Product number	Applicable tube outer diameter (mm)	L1 (mm)	L2 (mm)	S (mm)	F Tube insertion length (mm)	H1 Width across flat (mm)	H2 Width across flat (mm)	Min. inner diameter (mm)	Effective cross-sectional area (mm ²)	Weight (g)
4A08-2400	4	20.4	26.2	2.7	14	10.0	10.0	2.0	2.0	22.0
4A08-2600	6	20.4	27.4	2.6	14	10.0	12.0	4.0	8.0	25.0
4A08-2800	8	22.8	30.9	2.6	15	12.0	14.0	6.0	20.0	33.0
4A08-3000	10	27.0	36.8	2.3	18	14.0	17.0	7.5	31.0	52.0
4A08-3200	12	27.5	38.4	3.1	19	14.0	19.0	8.0	37.0	59.0

Brass nut

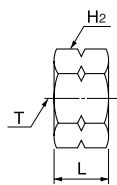

●Millimeter size type

Product number	Applicable tube outer diameter (mm)	T Thread size (M)	L (mm)	H2 Width across flat (mm)	Weight (g)
N4	4	M8×0.75	9.0	10.0	4.0
N6	6	M10×1.0	9.0	12.0	5.0
N8	8	M12×1.0	9.0	14.0	6.0
N10	10	M15×1.0	10.0	17.0	9.0
N12	12	M17×1.0	11.0	19.0	11.0

Brass sleeve

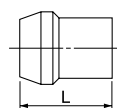

●Millimeter size type

Product number	Applicable tube outer diameter (mm)	L (mm)
MSN4	4	9.0
MSN6	6	9.0
MSN8	8	9.0
MSN10	10	10.0
MSN12	12	11.3

Insertless type requires a brass sleeve.

DK tube dedicated type

Screw-in type fitting dedicated for DK tube

Features

- **Screw-in type**
Fitting only for DK tube, consisting of three parts: fitting body, nut and sleeve.
- **Only the connector is sealed.**
Sealing tape is not required.



Cross-sectional structure diagram

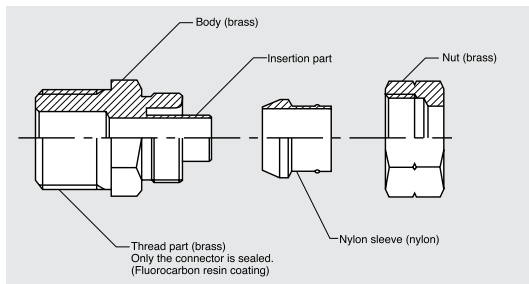

Operating fluid, working temperature range

Operating fluid	Working temperature range
Air	-40°C~+60°C

Pressure condition

Maximum working pressure: 1.0MPa
Negative pressure performance: -101.294kPa

Handling instructions

- ⚠ **Caution** This is dedicated for DK tube. Cannot be connected to other tubes.
- ⚠ **Caution** For use at a high temperature within the working temperature range, tighten the nut periodically. If the nut cannot be tightened further, cut the tube end and insert the tube again with a new sleeve.
- ⚠ **Caution** Do not bend the pipe sharply near the tube insertion port (sleeve end) of the fitting. Keep the tube straight for twice as long as the tube diameter from the insertion port.

📖 See page34 for the common handling instructions for tube fittings.

Reference

Instruction manual.....P.180
 Effective cross-sectional area.....P.176

Product number example

DC 6 - PT1/8

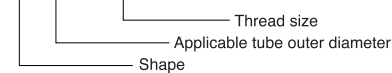

Applicable tube

Shape-keeping DK tube



P.24

DK tube dedicated type

Shape list

Connector DC  P.99	90 degree elbow DL  P.99	Tee DT  P.99	Union connector UDC  P.100	Union tee UDT  P.100
Panel touch connector DUT (Nickel plated)  P.100	Panel touch connector for copper pipe DUP (Nickel plated)  P.101	Brass nut N  P.101	Nylon sleeve SN  P.101	

Tube

Clean tube

Processed tube

PushOne fitting

QuickSeal fitting

Clean fitting/Chemifit

Bamboo-shoot fitting

Control switch/Detachable series

Jig/Tool/Accessory

Technical information

Reference

Connector

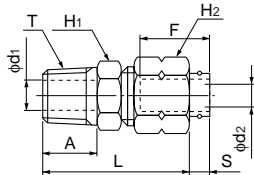

Product number	Applicable DK tube size (mm)	T Thread size (R)	L (mm)	A (mm)	F Tube insertion length (mm)	H ₁ Width across flat (mm)	H ₂ Width across flat (mm)	S (mm)	d ₁ (mm)	d ₂ (mm)	Effective cross-sectional area (mm ²)	Weight (g)
DC6-PT1/8	6	R1/8	28.0	11.0	15	10.0	12.0	4.6	5.0	2.8	6.0	14.5
DC6-PT1/4	6	R1/4	30.0	12.0	15	14.0	12.0	4.6	7.0	2.8	6.0	22.0
DC10-PT1/8	10	R1/8	30.1	11.0	17	17.0	17.0	4.2	5.0	5.7	18.0	28.0
DC10-PT1/4	10	R1/4	31.1	12.0	17	17.0	17.0	4.2	7.0	5.7	23.0	32.0
DC10-PT3/8	10	R3/8	32.1	13.0	17	17.0	17.0	4.2	9.0	5.7	23.0	38.0

90 degree elbow

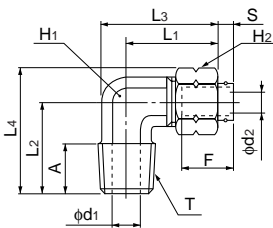

Product number	Applicable DK tube size (mm)	T Thread size (R)	L ₁ (mm)	L ₂ (mm)	L ₃ (mm)	L ₄ (mm)	A (mm)	F Tube insertion length (mm)	H ₁ Width across flat (mm)	H ₂ Width across flat (mm)	S (mm)	d ₁ (mm)	d ₂ (mm)	Effective cross-sectional area (mm ²)	Weight (g)
DL6-PT1/8	6	R1/8	20.5	18.5	26.2	25.4	11.0	15	10.0	12.0	4.6	5.0	2.8	5.0	21.0
DL6-PT1/4	6	R1/4	23.0	22.0	29.9	28.9	12.0	15	12.0	12.0	4.6	7.0	2.8	5.0	31.0
DL10-PT1/8	10	R1/8	27.1	22.0	35.2	31.8	11.0	17	14.0	17.0	4.2	5.0	5.7	16.0	42.0
DL10-PT1/4	10	R1/4	27.1	25.0	35.2	34.8	13.5	17	14.0	17.0	4.2	7.0	5.7	22.0	50.0
DL10-PT3/8	10	R3/8	27.1	26.0	35.7	35.8	13.0	17	14.0	17.0	4.2	9.0	5.7	22.0	53.0

Tee

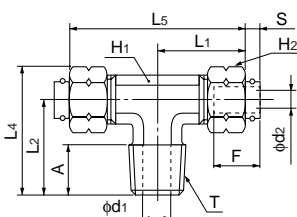

Product number	Applicable DK tube size (mm)	T Thread size (R)	L ₁ (mm)	L ₂ (mm)	L ₄ (mm)	L ₅ (mm)	A (mm)	F Tube insertion length (mm)	H ₁ Width across flat (mm)	H ₂ Width across flat (mm)	S (mm)	d ₁ (mm)	d ₂ (mm)	Effective cross-sectional area (mm ²)	Weight (g)
DT6-PT1/8	6	R1/8	20.5	18.5	25.4	40.9	11.0	15	10.0	12.0	4.6	5.0	2.8	5.0	30.0
DT6-PT1/4	6	R1/4	23.0	22.0	28.9	45.9	12.0	15	12.0	12.0	4.6	7.0	2.8	5.0	43.0
DT10-PT1/4	10	R1/4	27.1	25.0	34.8	54.2	12.0	17	14.0	17.0	4.2	7.0	5.7	22.0	71.0
DT10-PT3/8	10	R3/8	27.1	26.0	35.8	54.2	13.0	17	14.0	17.0	4.2	9.0	5.7	22.0	71.0

Tube

Clean tube

Processed tube

PushOne fitting

QuickSeal fitting

Clean fitting/ Chemfit

Bamboo-shoot fitting

Control switch/ Detachable series

Jig/Tool/ Accessory

Technical information

Reference

Union connector



Product number	Applicable DK tube size (mm)	L (mm)	F Tube insertion length (mm)	H ₁ Width across flat (mm)	H ₂ Width across flat (mm)	S (mm)	d ₂ (mm)	Effective cross-sectional area (mm ²)	Weight (g)
UDC6	6	32.9	15	10.0	12.0	4.6	2.8	6.0	20.0
UDC10	10	36.2	17	15.0	17.0	4.2	5.7	23.0	39.0

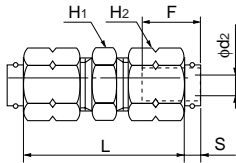

Union tee



Product number	Applicable DK tube size (mm)	L ₁ (mm)	L ₅ (mm)	L ₆ (mm)	L ₈ (mm)	F Tube insertion length (mm)	H ₁ Width across flat (mm)	H ₂ Width across flat (mm)	S (mm)	d ₂ (mm)	Effective cross-sectional area (mm ²)	Weight (g)
UDT6	6	20.5	40.9	20.5	27.4	15	10.0	12.0	4.6	2.8	4.0	35.0
UDT10	10	27.1	54.2	27.1	36.9	17	14.0	17.0	4.2	5.7	18.5	81.5

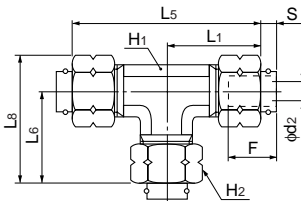

Panel touch connector (nickel plated)



Product number	Applicable DK tube size (mm)	L (mm)	F Tube insertion length (mm)	t Max. panel thickness (mm)	H ₂ Width across flat (mm)	H ₄ Width across flat (mm)	S (mm)	d ₂ (mm)	T ₂ Recommended panel hole diameter (mm)	Washer outer diameter (mm)	Washer thickness (mm)	Effective cross-sectional area (mm ²)	Weight (g)
DUT6	6	44.9	15	10	12.0	17.0	4.6	2.8	11	18	2.0	5.5	45.0
DUT10	10	51.2	17	7.1	17.0	24.0	4.2	5.7	16	28	3.0	21.5	104.0

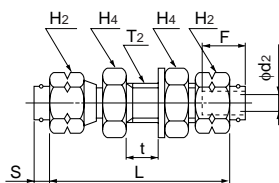

Tube

Clean tube

Processed tube

PushOne fitting

QuickSeal fitting

Clean fitting/ Chemifit

Bamboo-shoot fitting

Control switch/ Detachable series

Jig/Tool/ Accessory

Technical information

Reference

Panel touch connector for copper pipe (nickel plated)



Product number	Applicable DK tube size (mm)	Applicable copper pipe (mm)	L (mm)	F Tube insertion length (mm)	t Max. panel thickness (mm)	H ₂ Width across flat (mm)	H ₄ Width across flat (mm)	H ₅ Width across flat (mm)	S (mm)	d ₂ (mm)	T ₂ Recommended panel hole diameter (mm)	Washer outer diameter (mm)	Washer thickness (mm)	Effective cross-sectional area (mm ²)	Weight (g)
DUP6	6	6.0	51.0	15	10.0	12.0	17.0	14.0	4.6	2.8	11	18	2.0	5.5	49.0
DUP10	10	10.0	63.6	17	7.1	17.0	24.0	17.0	4.2	5.7	16	28	3.0	21.5	133.0

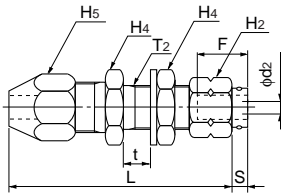

*Fitting part for connecting DK tube and copper pipe by panel touch method.

Brass nut



Product number	Applicable DK tube size (mm)	T Thread size (mm)	L (mm)	H ₂ (mm)	Weight (g)
N6	6	M10×1	9.0	12.0	5.0
N10	10	M15×1	10.0	17.0	9.0

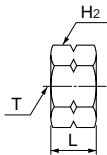

Nylon sleeve



Product number	Applicable DK tube size (mm)	L (mm)
SN6	6	11.0
SN10	10	12.0

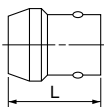

Tube

Clean tube

Processed tube

PushOne fitting

QuickSeal fitting

Clean fitting/Chemifit

Bamboo-shoot fitting

Control switch/Detachable series

Jig/Tool/Accessory

Technical information

Reference

QuickSeal Series

Nylon coil tube dedicated type

Screw-in type fitting dedicated for nylon coil tube

Features

- **Screw-in type**
Dedicated use for nylon coil tube. Consisting of three parts: fitting body, nut and sleeve.



Product number example

S1/4 - M1/4

Thread size
Product number of applicable nylon coil tube

Applicable tube

Nylon Coil Tube



P.32

Reference

Instruction manual.....P.180
Effective cross-sectional area.....P.176

Operating fluid, working temperature range

Operating fluid	Working temperature range
Air	-40°C~+100°C

Pressure condition

Maximum working pressure: 1.2MPa
Negative pressure performance: -101.294kPa

Handling instructions

- ⚠ **Caution** Dedicated for nylon coil tube. Cannot be used for connecting other types of tube.
- ⚠ **Caution** For use at a high temperature within the working temperature range, tighten the nut periodically. If the nut cannot be tightened further, cut the tube end and insert the tube again with a new sleeve.

📖 See page34 for the common handling instructions for tube fittings.

Connector



Product number	Applicable nylon coil tube outer diameter	T Thread size (R)	L (mm)	A (mm)	F Tube insertion length (mm)	H ₁ Width across flat (mm)	H ₂ Width across flat (mm)	d ₁ (mm)	D ₂ (mm)	Min. inner diameter (mm)	Effective cross-sectional area (mm ²)	Weight (g)
S3/16-M1/8	S3/16	R1/8	115.2	11.0	16	10.0	12.0	5.0	8.5	3.4	8.5	24.0
S1/4-M1/8	S1/4	R1/8	114.3	9.0	18	12.0	14.0	5.4	11.2	5.4	22.0	31.0
S1/4-M1/4	S1/4	R1/4	118.3	12.0	18	14.0	14.0	7.0	11.2	5.4	22.0	36.0
S3/8-M3/8	S3/8	R3/8	120.2	13.0	22	17.0	22.0	9.0	15.6	8.2	50.0	72.0
S1/2-M3/8	S1/2	R3/8	178.5	13.0	29	24.0	27.0	10.2	19.8	10.2	78.0	139.0
S1/2-M1/2	S1/2	R1/2	182.5	17.0	29	24.0	27.0	12.0	19.8	10.2	80.0	160.0
S3/4-M3/4	S3/4	R3/4	—	19.0	31	32.0	35.0	18.0	—	18.0	231.0	—

📖 S3/4 has no spring.

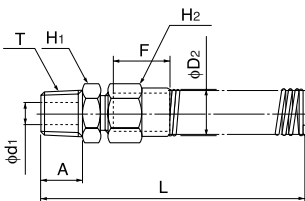

ES swivel nut internal connector



Product number	Applicable nylon coil tube outer diameter	T Thread size (G)	L (mm)	I (mm)	F Tube insertion length (mm)	H ₁ Width across flat (mm)	H ₂ Width across flat (mm)	H ₃ Width across flat (mm)	C (mm)	d ₁ (mm)	D ₂ (mm)	Effective cross-sectional area (mm ²)	Weight (g)
S1/4-ES1/4	S1/4	G1/4	123.3	8.5	18	14.0	14.0	19.0	9.0	5.0	11.2	18.5	53.0
S3/8-ES3/8	S3/8	G3/8	129.0	10.0	22	19.0	22.0	22.0	13.0	8.0	15.6	46.5	97.0
S1/2-ES1/2	S1/2	G1/2	189.0	13.0	29	24.0	27.0	27.0	16.0	10.2	19.8	80.0	186.0

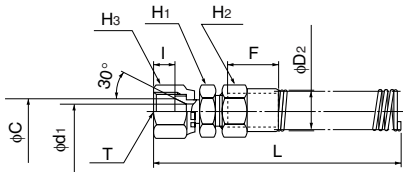

FS swivel nut internal connector



Product number	Applicable nylon coil tube outer diameter	T Thread size (G)	L (mm)	I (mm)	F Tube insertion length (mm)	H ₁ Width across flat (mm)	H ₂ Width across flat (mm)	H ₃ Width across flat (mm)	C (mm)	d ₁ (mm)	D ₂ (mm)	Effective cross-sectional area (mm ²)	Weight (g)
S1/4-FS1/4	S1/4	G1/4	123.3	5.7	18	14.0	14.0	19.0	7.0	5.0	11.2	18.5	55.0
S3/8-FS3/8	S3/8	G3/8	129.0	6.8	22	19.0	22.0	22.0	10.0	8.0	15.6	46.5	102.0
S1/2-FS1/2	S1/2	G1/2	189.0	9.5	29	24.0	27.0	27.0	14.0	10.2	19.8	80.0	193.0

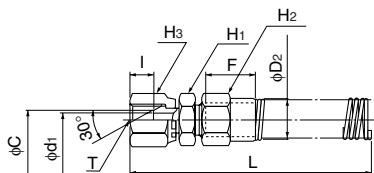

Nylon sleeve (dedicated for nylon coil tube)



(Red)

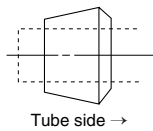

Tube side →

Caution
Pay attention to the directions when attaching the sleeve.

Product number	Applicable nylon coil tube outer diameter
SS3/16	S3/16
SS1/4	S1/4
SS3/8	S3/8
SS1/2	S1/2
SS3/4	S3/4

Insertion part for S3/4

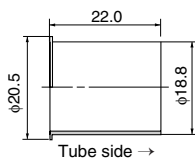

Tube side →

Product number	Applicable nylon coil tube outer diameter
SI3/4	S3/4

Tube

Clean tube

Processed tube

PushOne fitting

QuickSeal fitting

Clean fitting/Chemifit

Bamboo-shoot fitting

Control switch/Detachable series

Jig/Tool/Accessory

Technical information

Reference

Chemifit® C1 Series

PushOne® fitting for clean air, pure water and chemical liquids

Features

- **No-oil processed**
Assembled after cleaning each part in a clean room. No oil or fat is used in the sealing materials.
- **PushOne® connection of tube**
The tubes can be connected without using a jig or tools.
- **Nonmetal liquid-contact surface**
No contact of liquid and metal, preventing the metal ions from dissolving.
- **High dust-free, uncontaminated performance**
Made of special polypropylene resin.
- **Highly smooth inner surface**
Smooth inner surface due to ejection forming.
- **Double clean package**
Each fitting is packed in a clean room and put in a zipper sealed bag.
- **Easy directional setting of tube**
The body can rotate freely even after tightening up the thread part. Good for piping of Elbow and Tee.
- **Compliant with the MHLW Ministerial Notification No.201(2006), MHW Ministerial Notification No.370(1959), Japan**

Cross-sectional structure diagram

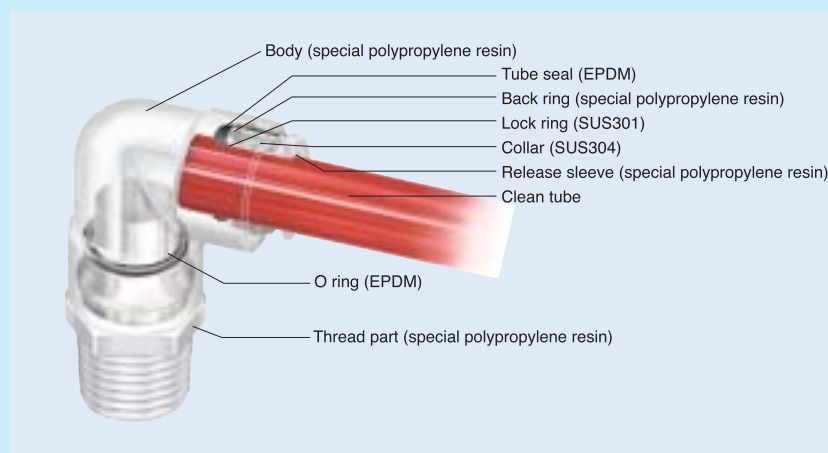

Product number example

EL 6 - R1/8 - C1

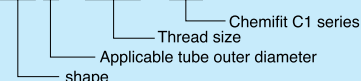

Distinction of millimeter/inch sizes

- The tube size is shown on the release sleeve.



Operating fluid, working temperature range

Operating fluid	Working temperature range
Air (clean air)	-20°C~+80°C
Water (pure water)	0°C~+80°C

- ☞ Contact us for various chemical liquids.
- ☞ See "Combination List of Tube and Fitting" on page 8.

Pressure condition

Maximum working pressure: 0.7MPa(at20°C)
Negative pressure performance: -99.975kPa

Relation between the working temperature and the maximum working pressure

The maximum working pressure varies with the working temperature (environmental temperature). For use at an abnormal temperature, always check the maximum working pressure change in the graph below and keep the pressure within the range.

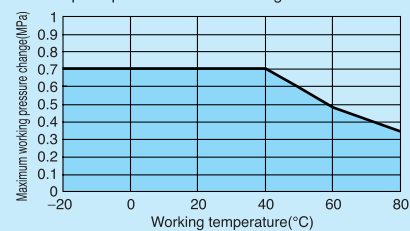

Handling instructions

- ⚠ **Caution** When the working conditions of tubes and fittings differ, use them under the lower specified conditions.
 - ⚠ **Caution** Stress relaxation occurs more readily with resin thread than with metal thread. The relaxation is prominent at a high temperature. Tighten the thread periodically.
 - ⚠ **Caution** When water is used as the operating fluid, confirm that there is no water leakage damage to equipment and instruments due to construction failure.
 - ⚠ **Caution** When water is used as the operating fluid, do not allow it to freeze.
 - ⚠ **Caution** Do not bend the pipe sharply near the tube insertion port (sleeve end) of the fitting. Keep the tube straight for twice as long as the tube diameter from the insertion port.
- ☞ See page34 for the common handling instructions for tube fittings.

Applicable tube

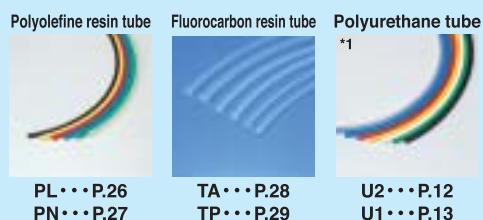

PL...P.26
PN...P.27

TA...P.28
TP...P.29

U2...P.12
U1...P.13

Allied products and product introduction



Reference

Instruction manual.....P.182
Chemical resistance specification table.....P.207
Effective cross-sectional areaP.176
Negative-pressure performance list.....P.177

(*1) Combinatory use of U2 or U1 tube and Chemifit C1 series mixes general and clean type performances. When using them in a clean environment, pay attention to the clean level that could be lowered.

Chemifit® C1 Series

Shape list



Tube

Clean tube

Processed tube

PushOne fitting

QuickSeal fitting

Clean fitting/ Chemifit

Bamboo-shoot fitting

Control switch/ Detachable series

Jig/Tool/ Accessory

Technical information

Reference

No-oil processing, Clean wrapping and packaging

- Ultrasonic cleaning with no oil or fat used for assembling in a clean room

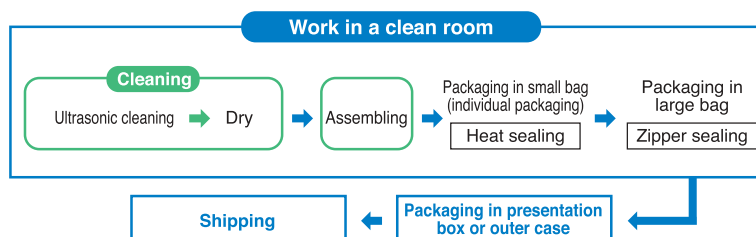

- High-barrier sheet packaging available

What is high-barrier sheet packaging?

In order to maintain the cleanliness of our products, no space for oxygen, water, or corrosive gas is allowed inside the package so a packaging bag with a high gas barrier is needed for protecting the content from these gases. To meet this requirement, Nitta provides high-barrier bags with a high gas barrier performance also for nitrogen sealing or atmospheric sealing.



- The packaging bags that Nitta uses have the highest gas barrier performance among clear bags.
- The bags do not contain halogen, etc, for safe burning.

Connector

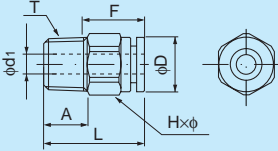

●Millimeter size type

Product number	Applicable tube outer diameter (mm)	T Thread size (R)	L (mm)	A (mm)	F Tube insertion length (mm)	H×φ Width across flat (mm)	D (mm)	d ₁ (mm)	Effective cross-sectional area (mm ²)	Weight (g)
EC4-R1/8-C1	4	R1/8	21.9	9.0	14	12.0×13.0	9.7	2.5	4.0	2.0
EC4-R1/4-C1	4	R1/4	24.9	12.0	14	14.0×15.4	9.7	2.5	4.0	2.0
EC6-R1/8-C1	6	R1/8	23.6	9.0	15	14.0×15.4	12.5	4.0	10.5	2.0
EC6-R1/4-C1	6	R1/4	26.6	12.0	15	14.0×15.4	12.5	4.0	10.5	3.0
EC8-R1/8-C1	8	R1/8	28.6	9.0	16	17.0×18.5	14.5	6.0	20.0	4.0
EC8-R1/4-C1	8	R1/4	27.6	12.0	16	17.0×18.5	14.5	6.0	25.0	4.0
EC10-R1/4-C1	10	R1/4	32.4	12.0	19	19.0×21.0	17.5	8.0	40.0	7.0
EC10-R3/8-C1	10	R3/8	33.2	14.0	19	19.0×21.0	17.5	8.0	40.0	7.0
EC10-R1/2-C1	10	R1/2	35.4	16.0	19	22.0×24.5	17.5	8.0	—	—
EC12-R3/8-C1	12	R3/8	33.4	14.0	20	22.0×24.5	21.0	10.0	50.0	9.0
EC12-R1/2-C1	12	R1/2	35.4	16.0	20	22.0×24.5	21.0	10.0	50.0	11.0

EC6-N1/8-C1	6	NPT1/8	23.6	9.0	15	14.0×15.4	12.5	4.0	10.5	2.0
EC6-N1/4-C1	6	NPT1/4	26.6	12.0	15	14.0×15.4	12.5	4.0	10.5	3.0
EC10-N1/4-C1	10	NPT1/4	32.4	12.0	19	19.0×21.0	17.5	8.0	40.0	7.0

●Inch size type

Product number	Applicable tube outer diameter (inch)	T Thread size (R)	L (mm)	A (mm)	F Tube insertion length (mm)	H×φ Width across flat (mm)	D (mm)	d ₁ (mm)	Effective cross-sectional area (mm ²)	Weight (g)
EC1/4-R1/8-C1	1/4	R1/8	24.6	9.0	16	14.0×15.4	12.5	4.0	12.0	2.0
EC1/4-R1/4-C1	1/4	R1/4	27.6	12.0	16	14.0×15.4	12.5	4.0	12.0	3.0
EC3/8-R1/4-C1	3/8	R1/4	33.2	12.0	20	19.0×21.0	17.5	8.0	35.0	7.0
EC3/8-R3/8-C1	3/8	R3/8	34.0	14.0	20	19.0×21.0	17.5	8.0	35.0	7.0
EC1/2-R3/8-C1	1/2	R3/8	26.1	14.0	23	22.0×24.5	21.0	10.0	66.5	9.0
EC1/2-R1/2-C1	1/2	R1/2	29.1	16.0	23	22.0×24.5	21.0	10.0	66.5	10.0

Through connector A tube can be inserted completely through the connector.

●Millimeter size type

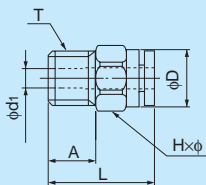

Product number	Applicable tube outer diameter (mm)	T Thread size (R)	L (mm)	A (mm)	H×φ Width across flat (mm)	D (mm)	d ₁ (mm)	Weight (g)
ETC4-R1/8-C1	4	R1/8	21.9	9.0	12.0×13.0	9.7	4.2	2.0
ETC4-R1/4-C1	4	R1/4	24.9	12.0	14.0×15.4	9.7	4.2	2.0
ETC6-R1/4-C1	6	R1/4	26.6	12.0	14.0×15.4	12.5	6.6	3.0
ETC8-R1/4-C1	8	R1/4	27.6	12.0	17.0×18.5	14.5	8.2	4.0
ETC10-R3/8-C1	10	R3/8	33.2	14.0	19.0×21.0	17.5	10.2	7.0
ETC12-R1/2-C1	12	R1/2	35.4	16.0	22.0×24.5	21.0	12.3	10.0

Tube
Clean tube
Processed tube
PushOne fitting
QuickSeal fitting
Clean fitting/ Chemifit
Bamboo-shoot fitting
Control switch/ Detachable series
Jig/Tool/ Accessory
Technical information
Reference

90 degree elbow

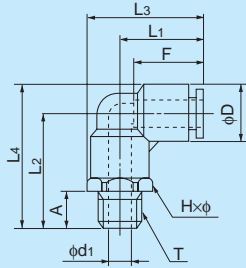

●Millimeter size type

Product number	Applicable tube outer diameter (mm)	T Thread size (R)	L ₁ (mm)	L ₂ (mm)	L ₃ (mm)	L ₄ (mm)	A (mm)	F Tube insertion length (mm)	H×φ Width across flat (mm)	D (mm)	d ₁ (mm)	Min. inner diameter (mm)	Effective cross-sectional area (mm ²)	Weight (g)
EL4-R1/8-C1	4	R1/8	17.7	23.7	23.2	28.6	9.0	14	10.0×11.0	10.0	5.0	3.0	4.0	2.0
EL4-R1/4-C1	4	R1/4	17.7	27.7	25.4	32.6	12.0	14	14.0×15.4	10.0	7.0	3.0	4.0	3.0
EL6-R1/8-C1	6	R1/8	18.9	26.2	25.4	32.5	9.0	15	12.0×13.0	13.0	4.5	4.5	12.0	4.0
EL6-R1/4-C1	6	R1/4	18.9	30.2	26.6	36.5	12.0	15	14.0×15.4	13.0	7.0	4.5	12.0	4.0
EL8-R1/8-C1	8	R1/8	21.1	29.2	28.8	36.5	9.0	16	14.0×15.4	15.0	6.0	6.0	18.5	5.0
EL8-R1/4-C1	8	R1/4	21.1	31.2	28.8	38.5	12.0	16	14.0×15.4	15.0	6.5	6.5	23.0	6.0
EL10-R1/4-C1	10	R1/4	25.0	37.2	34.3	46.0	12.0	19	17.0×18.5	18.0	8.0	8.0	34.5	9.0
EL10-R3/8-C1	10	R3/8	25.0	37.2	34.3	46.0	14.0	19	17.0×18.5	18.0	9.0	8.0	37.0	11.0
EL12-R3/8-C1	12	R3/8	26.7	38.7	37.2	48.8	14.0	20	19.0×21.0	20.5	10.0	10.0	43.0	13.0
EL12-R1/2-C1	12	R1/2	26.7	41.7	38.7	51.8	16.0	20	22.0×24.0	20.5	12.0	9.5	43.0	15.0

EL6-N1/8-C1	6	NPT1/8	18.9	26.2	25.4	32.5	9.0	15	12.0×13.0	13.0	4.5	4.5	12.0	4.0
EL6-N1/4-C1	6	NPT1/4	18.9	30.2	26.6	36.5	12.0	15	14.0×15.4	13.0	7.0	4.5	12.0	4.0

●Inch size type

Product number	Applicable tube outer diameter (inch)	T Thread size (R)	L ₁ (mm)	L ₂ (mm)	L ₃ (mm)	L ₄ (mm)	A (mm)	F Tube insertion length (mm)	H×φ Width across flat (mm)	D (mm)	d ₁ (mm)	Min. inner diameter (mm)	Effective cross-sectional area (mm ²)	Weight (g)
EL1/4-R1/8-C1	1/4	R1/8	19.9	26.2	26.4	32.5	9.0	16	12.0×13.0	13.0	4.5	4.5	13.0	4.0
EL1/4-R1/4-C1	1/4	R1/4	19.9	30.2	27.6	36.5	12.0	16	14.0×15.4	13.0	7.0	4.5	13.0	4.0
EL3/8-R1/4-C1	3/8	R1/4	25.8	37.2	35.1	46.0	12.0	20	17.0×18.5	18.0	8.0	8.0	30.0	9.0
EL3/8-R3/8-C1	3/8	R3/8	25.8	37.2	35.1	46.0	14.0	20	17.0×18.5	18.0	9.0	8.0	32.0	11.0
EL1/2-R3/8-C1	1/2	R3/8	28.7	39.0	39.2	49.6	14.0	23	19.0×21.0	21.5	10.0	10.0	53.0	13.0
EL1/2-R1/2-C1	1/2	R1/2	28.7	42.0	40.7	52.6	16.0	23	22.0×24.0	21.5	12.0	9.5	55.5	15.0

Tee

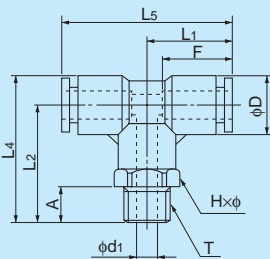

●Millimeter size type

Product number	Applicable tube outer diameter (mm)	T Thread size (R)	L ₁ (mm)	L ₂ (mm)	L ₄ (mm)	L ₅ (mm)	A (mm)	F Tube insertion length (mm)	H×φ Width across flat (mm)	D (mm)	d ₁ (mm)	Min. inner diameter (mm)	Effective cross-sectional area (mm ²)	Weight (g)
ET4-R1/8-C1	4	R1/8	17.7	23.7	28.6	35.3	9.0	14	10.0×11.0	10.0	5.0	3.0	4.0	3.0
ET4-R1/4-C1	4	R1/4	17.7	27.7	32.6	35.3	12.0	14	14.0×15.4	10.0	7.0	3.0	4.0	4.0
ET6-R1/8-C1	6	R1/8	18.9	26.2	32.5	37.9	9.0	15	12.0×13.0	13.0	4.5	4.5	12.0	5.0
ET6-R1/4-C1	6	R1/4	18.9	30.2	36.5	37.9	12.0	15	14.0×15.4	13.0	7.0	4.5	12.0	6.0
ET8-R1/8-C1	8	R1/8	21.1	29.2	36.5	42.2	9.0	16	14.0×15.4	15.0	6.0	6.0	18.5	7.0
ET8-R1/4-C1	8	R1/4	21.1	31.2	38.5	42.2	12.0	16	14.0×15.4	15.0	6.5	6.5	23.0	8.0
ET10-R1/4-C1	10	R1/4	25.0	37.2	46.0	50.0	12.0	19	17.0×18.5	18.0	8.0	8.0	34.5	14.0
ET10-R3/8-C1	10	R3/8	25.0	37.2	46.0	50.0	14.0	19	17.0×18.5	18.0	9.0	8.0	37.0	16.0
ET12-R3/8-C1	12	R3/8	26.7	38.7	48.8	53.4	14.0	20	19.0×21.0	20.5	10.0	10.0	43.0	19.0
ET12-R1/2-C1	12	R1/2	26.7	41.7	51.8	53.4	16.0	20	22.0×24.0	20.5	12.0	9.5	43.0	21.0

ET6-N1/8-C1	6	NPT1/8	18.9	26.2	32.5	37.9	9.0	15	12.0×13.0	13.0	4.5	4.5	12.0	5.0
ET6-N1/4-C1	6	NPT1/4	18.9	30.2	36.5	37.9	12.0	15	14.0×15.4	13.0	7.0	4.5	12.0	6.0

●Inch size type

Product number	Applicable tube outer diameter (inch)	T Thread size (R)	L ₁ (mm)	L ₂ (mm)	L ₄ (mm)	L ₅ (mm)	A (mm)	F Tube insertion length (mm)	H×φ Width across flat (mm)	D (mm)	d ₁ (mm)	Min. inner diameter (mm)	Effective cross-sectional area (mm ²)	Weight (g)
ET1/4-R1/8-C1	1/4	R1/8	19.9	26.2	32.5	39.8	9.0	16	12.0×13.0	13.0	4.5	4.5	13.0	5.0
ET1/4-R1/4-C1	1/4	R1/4	19.9	30.2	36.5	39.8	12.0	16	14.0×15.4	13.0	7.0	4.5	13.0	6.0
ET3/8-R1/4-C1	3/8	R1/4	25.8	37.2	46.0	51.6	12.0	20	17.0×18.5	18.0	8.0	8.0	30.0	14.0
ET3/8-R3/8-C1	3/8	R3/8	25.8	37.2	46.0	51.6	14.0	20	17.0×18.5	18.0	9.0	8.0	32.0	16.0
ET1/2-R3/8-C1	1/2	R3/8	28.7	39.0	49.6	57.5	14.0	23	19.0×21.0	21.5	10.0	10.0	53.0	19.0
ET1/2-R1/2-C1	1/2	R1/2	28.7	42.0	52.6	57.5	16.0	23	22.0×24.0	21.5	12.0	9.5	55.5	21.0

Tube

Clean tube

Processed tube

PushOne fitting

QuickSeal fitting

Clean fitting/ Chemifit

Bamboo-shoot fitting

Control switch/ Detachable series

Jig/Tool/ Accessory

Technical information

Reference

Service tee

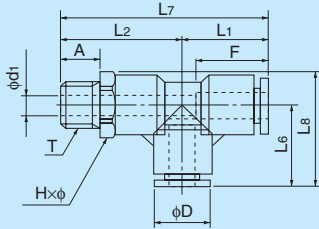

●Millimeter size type

Product number	Applicable tube outer diameter (mm)	T Thread size (R)	L ₁ (mm)	L ₂ (mm)	L ₈ (mm)	L ₇ (mm)	L ₈ (mm)	A (mm)	F Tube insertion length (mm)	H×φ Width across flat (mm)	D (mm)	d ₁ (mm)	Min. inner diameter (mm)	Effective cross-sectional area (mm ²)	Weight (g)
EST4-R1/8-C1	4	R1/8	17.7	23.7	17.7	41.4	23.2	9.0	13	10.0×11.0	10.0	5.0	3.0	4.0	3.0
EST4-R1/4-C1	4	R1/4	17.7	27.7	17.7	45.4	25.4	12.0	13	14.0×15.4	10.0	7.0	3.0	4.0	4.0
EST6-R1/8-C1	6	R1/8	18.9	26.2	18.9	45.1	25.4	9.0	15	12.0×13.0	13.0	4.5	4.5	12.0	5.0
EST6-R1/4-C1	6	R1/4	18.9	30.2	18.9	49.1	26.6	12.0	15	14.0×15.4	13.0	7.0	4.5	12.0	6.0
EST8-R1/8-C1	8	R1/8	21.1	29.2	21.1	50.3	28.8	9.0	16	14.0×15.4	15.0	6.0	6.0	18.5	7.0
EST8-R1/4-C1	8	R1/4	21.1	31.2	21.1	52.3	28.8	12.0	16	14.0×15.4	15.0	6.5	6.5	23.0	8.0
EST10-R1/4-C1	10	R1/4	25.0	37.2	25.0	62.2	34.3	12.0	19	17.0×18.5	18.0	8.0	8.0	34.5	14.0
EST10-R3/8-C1	10	R3/8	25.0	37.2	25.0	62.2	34.3	14.0	19	17.0×18.5	18.0	9.0	8.0	37.0	16.0
EST12-R3/8-C1	12	R3/8	26.7	38.7	26.7	65.4	37.2	14.0	20	19.0×21.0	20.5	10.0	10.0	43.0	19.0
EST12-R1/2-C1	12	R1/2	26.7	41.7	26.7	68.4	38.7	16.0	20	22.0×24.0	20.5	12.0	9.5	43.0	21.0

EST6-N1/8-C1	6	NPT1/8	18.9	26.2	18.9	45.1	25.4	9.0	15	12.0×13.0	13.0	4.5	4.5	12.0	5.0
EST6-N1/4-C1	6	NPT1/4	18.9	30.2	18.9	49.1	26.6	12.0	15	14.0×15.4	13.0	7.0	4.5	12.0	6.0

●Inch size type

Product number	Applicable tube outer diameter (inch)	T Thread size (R)	L ₁ (mm)	L ₂ (mm)	L ₈ (mm)	L ₇ (mm)	L ₈ (mm)	A (mm)	F Tube insertion length (mm)	H×φ Width across flat (mm)	D (mm)	d ₁ (mm)	Min. inner diameter (mm)	Effective cross-sectional area (mm ²)	Weight (g)
EST1/4-R1/8-C1	1/4	R1/8	19.9	26.2	19.9	46.1	26.4	9.0	16	12.0×13.0	13.0	4.5	4.5	13.0	5.0
EST1/4-R1/4-C1	1/4	R1/4	19.9	30.2	19.9	50.1	27.6	12.0	16	14.0×15.4	13.0	7.0	4.5	13.0	6.0
EST3/8-R1/4-C1	3/8	R1/4	25.8	37.2	25.8	63.0	35.1	12.0	19	17.0×18.5	18.0	8.0	8.0	30.0	14.0
EST3/8-R3/8-C1	3/8	R3/8	25.8	37.2	25.8	63.0	35.1	14.0	19	17.0×18.5	18.0	9.0	8.0	32.0	16.0
EST1/2-R3/8-C1	1/2	R3/8	29.7	39.0	29.7	68.4	40.2	14.0	21	19.0×21.0	21.5	10.0	10.0	53.0	19.0
EST1/2-R1/2-C1	1/2	R1/2	29.7	42.0	29.7	71.4	41.7	16.0	21	22.0×24.0	21.5	12.0	9.5	55.5	21.0

Y joint

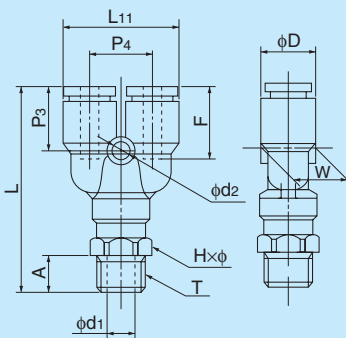

●Millimeter size type

Product number	Applicable tube outer diameter (mm)	T Thread size (R)	L (mm)	L ₁₁ (mm)	A (mm)	F Tube insertion length (mm)	H×φ Width across flat (mm)	P ₃ (mm)	P ₄ (mm)	W (mm)	D (mm)	d ₁ (mm)	d ₂ (mm)	Min. inner diameter (mm)	Effective cross-sectional area (mm ²)	Weight (g)
EY4-R1/8-C1	4	R1/8	41.9	20.7	9.0	14	10.0×11.0	13.9	11.0	9.7	10.0	5.0	3.2	3.0	3.5	4.0
EY4-R1/4-C1	4	R1/4	45.9	20.7	12.0	14	14.0×15.4	13.9	11.0	9.7	10.0	7.0	3.2	3.0	3.5	5.0
EY6-R1/8-C1	6	R1/8	45.2	24.7	9.0	15	12.0×13.0	15.2	12.2	12.5	13.0	4.5	4.2	4.5	9.0	6.0
EY6-R1/4-C1	6	R1/4	49.2	24.7	12.0	15	14.0×15.4	15.2	12.2	12.5	13.0	7.0	4.2	4.5	9.0	7.0
EY8-R1/8-C1	8	R1/8	50.3	28.7	9.0	16	14.0×15.4	16.8	14.2	14.5	15.0	6.0	4.2	6.0	17.5	8.0
EY8-R1/4-C1	8	R1/4	52.3	28.7	12.0	16	14.0×15.4	16.8	14.2	14.5	15.0	6.5	4.2	6.5	20.0	9.0
EY10-R1/4-C1	10	R1/4	60.2	35.0	12.0	19	17.0×18.5	18.7	17.5	17.5	18.0	8.0	4.2	8.0	27.5	15.0
EY10-R3/8-C1	10	R3/8	60.2	35.0	14.0	19	17.0×18.5	18.7	17.5	17.5	18.0	9.0	4.2	8.0	28.0	16.0
EY12-R3/8-C1	12	R3/8	64.2	40.0	14.0	20	19.0×21.0	20.7	20.0	20.0	20.5	10.0	4.2	10.0	40.0	22.0
EY12-R1/2-C1	12	R1/2	67.2	40.0	16.0	20	22.0×24.0	20.7	20.0	20.0	20.5	12.0	4.2	9.5	40.0	23.0

EY6-N1/8-C1	6	NPT1/8	45.2	24.7	9.0	15	12.0×13.0	15.2	12.2	12.5	13.0	4.5	4.2	4.5	9.0	6.0
EY6-N1/4-C1	6	NPT1/4	49.2	24.7	12.0	15	14.0×15.4	15.2	12.2	12.5	13.0	7.0	4.2	4.5	9.0	7.0

●Inch size type

Product number	Applicable tube outer diameter (inch)	T Thread size (R)	L (mm)	L ₁₁ (mm)	A (mm)	F Tube insertion length (mm)	H×φ Width across flat (mm)	P ₃ (mm)	P ₄ (mm)	W (mm)	D (mm)	d ₁ (mm)	d ₂ (mm)	Min. inner diameter (mm)	Effective cross-sectional area (mm ²)	Weight (g)
EY1/4-R1/8-C1	1/4	R1/8	46.2	24.7	9.0	16	12.0×13.0	16.2	12.2	12.5	13.0	4.5	4.2	4.5	10.5	6.0
EY1/4-R1/4-C1	1/4	R1/4	50.2	24.7	12.0	16	14.0×15.4	16.2	12.2	12.5	13.0	7.0	4.2	4.5	10.5	7.0
EY3/8-R1/4-C1	3/8	R1/4	61.0	35.0	12.0	20	17.0×18.5	19.5	17.5	17.5	18.0	8.0	4.2	8.0	26.0	15.0
EY3/8-R3/8-C1	3/8	R3/8	61.0	35.0	14.0	20	17.0×18.5	19.5	17.5	17.5	18.0	9.0	4.2	8.0	26.0	16.0
EY1/2-R3/8-C1	1/2	R3/8	67.7	42.0	14.0	23	19.0×21.0	22.7	21.0	21.0	21.5	10.0	4.2	10.0	48.0	22.0
EY1/2-R1/2-C1	1/2	R1/2	70.7	42.0	16.0	23	22.0×24.0	22.7	21.0	21.0	21.5	12.0	4.2	9.5	48.0	23.0

Tube
Clean tube
Processed tube
PushOne fitting
QuickSeal fitting
Clean fitting/ Chemifit
Bamboo-shoot fitting
Control switch/ Detachable series
Jig/Tool/ Accessory
Technical information
Reference

Union connector



●Millimeter size type

Product number	d1 Applicable tube outer diameter (mm)	d2 Applicable tube outer diameter (mm)	L	L1	P1	F1 Tube insertion length (mm)	F2 Tube insertion length (mm)	d3	D1	D2	W	Min. inner diameter (mm)	Effective cross- sectional area (mm ²)	Weight (g)
EUC3-C1	3	3	23.2	11.6	3.6	11	11	3.2	6.3	6.3	6.0	2.0	2.5	—
EUC4-C1	4	4	32.7	16.4	5.0	14	13	4.2	10.0	10.0	9.7	3.0	3.5	2.0
EUC6-C1	6	6	34.5	17.2	6.0	15	15	4.2	13.0	13.0	12.5	5.0	12.5	4.0
EUC8-C1	8	8	36.6	18.3	7.0	16	16	4.2	15.0	15.0	14.5	7.0	28.0	5.0
EUC10-C1	10	10	42.4	21.2	8.5	19	19	4.2	18.0	18.0	17.5	9.0	45.0	10.0
EUC12-C1	12	12	44.4	22.2	9.8	20	20	4.2	20.5	20.5	20.0	11.0	67.0	14.0

●Inch size type

Product number	d1 Applicable tube outer diameter (inch)	d2 Applicable tube outer diameter (inch)	L	L1	P1	F1 Tube insertion length (mm)	F2 Tube insertion length (mm)	d3	D1	D2	W	Min. inner diameter (mm)	Effective cross- sectional area (mm ²)	Weight (g)
EUC1/8-C1	1/8	1/8	25.0	12.5	4.5	11	11	3.2	8.0	8.0	8.0	3.0	—	—
EUC1/4-C1	1/4	1/4	36.4	18.2	6.0	16	16	4.2	13.0	13.0	12.5	5.0	12.5	4.0
EUC3/8-C1	3/8	3/8	44.0	22.0	8.5	20	16	4.2	18.0	18.0	17.5	9.0	28.0	10.0
EUC1/2-C1	1/2	1/2	48.5	24.2	10.3	23	23	4.2	21.5	21.5	21.0	11.0	35.0	19.0

●Inch size type (different diameter connection)

Product number	d1 Applicable tube outer diameter (inch)	d2 Applicable tube outer diameter (inch)	L	L1	P1	F1 Tube insertion length (mm)	F2 Tube insertion length (mm)	d3	D1	D2	W	Min. inner diameter (mm)	Effective cross- sectional area (mm ²)	Weight (g)
EUC1/8-1/4-C1	1/8	1/4	36.1	20.1	6.0	11	16	3.2	8.0	13.0	12.5	2.5	—	—
EUC1/4-3/8-C1	1/4	3/8	40.7	22.0	8.5	16	20	4.2	13.0	18.0	17.5	5.0	—	—
EUC3/8-1/2-C1	3/8	1/2	46.2	24.2	9.8	20	23	4.2	18.0	21.5	20.0	9.0	—	—

●Inch size — millimeter size connection

Product number	d1 Applicable tube outer diameter (inch)	d2 Applicable tube outer diameter (mm)	L	L1	P1	F1 Tube insertion length (mm)	F2 Tube insertion length (mm)	d3	D1	D2	W	Min. inner diameter (mm)	Effective cross- sectional area (mm ²)	Weight (g)
EUC1/4-6-C1	1/4	6	35.4	17.2	6.0	16	15	4.2	13.0	13.0	12.5	5.0	12.5	4.0
EUC3/8-10-C1	3/8	10	43.2	21.2	8.5	20	19	4.2	18.0	18.0	17.5	9.0	45.0	10.0

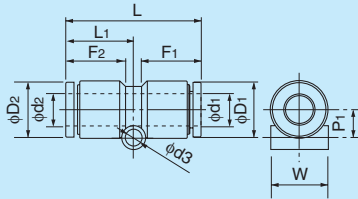

90 degree union elbow



●Millimeter size type

Product number	Applicable tube outer diameter (mm)	L1	L8	P1	F Tube insertion length (mm)	D	W	Min. inner diameter (mm)	Effective cross- sectional area (mm ²)	Weight (g)
EUL3-C1	3	12.6	15.8	4.1	11	6.3	6	2.0	2.0	—
EUL4-C1	4	17.7	22.6	6.9	14	10.0	9.7	3.0	3.5	3.0
EUL6-C1	6	18.9	25.2	8.3	15	13.0	12.5	5.0	9.5	4.0
EUL8-C1	8	21.1	28.5	9.3	16	15.0	14.5	7.0	19.5	6.0
EUL10-C1	10	25.0	32.8	10.8	19	18.0	17.5	9.0	32.5	12.0
EUL12-C1	12	26.7	36.8	12.1	20	20.5	20.0	11.0	45.5	16.0

●Inch size type

Product number	Applicable tube outer diameter (inch)	L1	L8	P1	F Tube insertion length (mm)	D	W	Min. inner diameter (mm)	Effective cross- sectional area (mm ²)	Weight (g)
EUL1/8-C1	1/8	15.0	19.0	5.0	11	8.0	8.0	2.5	—	—
EUL1/4-C1	1/4	19.9	26.2	8.3	16	13.0	12.5	5.0	12.0	4.0
EUL3/8-C1	3/8	25.8	34.6	10.8	20	18.0	17.5	9.0	27.0	12.0
EUL1/2-C1	1/2	29.7	40.2	12.6	23	21.5	21.0	11.0	54.5	20.0

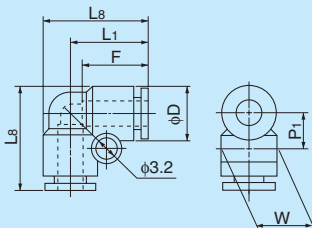

Tube

Clean tube

Processed tube

PushOne fitting

QuickSeal fitting

Clean fitting/
Chemifit

Bamboo-
shoot fitting

Control switch/
Detachable series

Jig/Tool/
Accessory

Technical
information

Reference

Union tee



●Millimeter size type

Product number	Applicable tube outer diameter (mm)	L ₁ (mm)	L ₅ (mm)	L ₆ (mm)	L ₈ (mm)	P ₁ (mm)	P ₂ (mm)	F Tube insertion length (mm)	D (mm)	d ₂ (mm)	W (mm)	Min. inner diameter (mm)	Effective cross-sectional area (mm ²)	Weight (g)
EUT3-C1	3	12.6	25.1	12.6	15.8	4.1	8.3	11	6.3	3.1	6	2.0	2.0	1.5
EUT4-C1	4	17.7	35.3	17.7	22.6	6.9	14.0	13	10.0	4.2	9.7	3.0	3.5	4.0
EUT6-C1	6	18.9	37.9	18.9	25.2	8.3	17.0	15	13.0	4.2	12.5	5.0	9.5	7.0
EUT8-C1	8	21.1	42.2	21.1	28.5	9.3	19.0	16	15.0	4.2	14.5	7.0	19.5	9.0
EUT10-C1	10	25.0	50.0	25.0	33.8	10.8	22.0	19	18.0	4.2	17.5	9.0	32.5	17.0
EUT12-C1	12	26.7	53.4	26.7	36.8	12.1	24.0	20	20.5	4.2	20.0	11.0	45.5	23.0

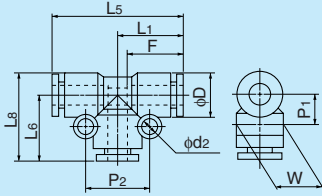

●Inch size type

Product number	Applicable tube outer diameter (inch)	L ₁ (mm)	L ₅ (mm)	L ₆ (mm)	L ₈ (mm)	P ₁ (mm)	P ₂ (mm)	F Tube insertion length (mm)	D (mm)	d ₂ (mm)	W (mm)	Min. inner diameter (mm)	Effective cross-sectional area (mm ²)	Weight (g)
EUT1/8-C1	1/8	15.0	30.0	15.0	19.0	5.0	10.0	11	8.0	3.2	8.0	2.5	—	—
EUT1/4-C1	1/4	19.9	39.8	19.9	26.2	8.3	17.0	15	13.0	4.2	12.5	5.0	12.0	7.0
EUT3/8-C1	3/8	25.8	51.6	25.8	34.6	10.8	22.0	19	18.0	4.2	17.5	9.0	27.0	17.0
EUT1/2-C1	1/2	29.7	59.5	29.7	40.2	12.6	25.0	21	21.5	4.2	21.0	11.0	54.5	29.0

Y union



●Millimeter size type

Product number	Applicable tube outer diameter (mm)	L (mm)	L ₁₁ (mm)	F Tube insertion length (mm)	P ₃ (mm)	P ₄ (mm)	W (mm)	D (mm)	d ₂ (mm)	Min. inner diameter (mm)	Effective cross-sectional area (mm ²)	Weight (g)
EYB3-C1	3	25.7	13.0	11	10.9	7.0	6.0	6.3	2.0	2.0	2	—
EYB4-C1	4	34.7	20.7	14	13.9	11.0	9.7	10.0	3.2	3.0	3.0	4.0
EYB6-C1	6	38.4	24.7	15	15.2	12.2	12.5	13.0	4.2	5.0	8.0	6.0
EYB8-C1	8	43.7	28.7	16	16.8	14.2	14.5	15.0	4.2	7.0	18.0	9.0
EYB10-C1	10	49.0	35.0	19	18.7	17.5	17.5	18.0	4.2	9.0	27.0	17.0
EYB12-C1	12	54.8	40.0	20	20.7	20.0	20.0	20.5	4.2	11.0	38.5	24.0

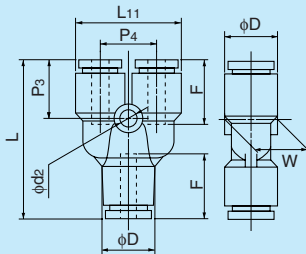

●Inch size type

Product number	Applicable tube outer diameter (inch)	L (mm)	L ₁₁ (mm)	F Tube insertion length (mm)	P ₃ (mm)	P ₄ (mm)	W (mm)	D (mm)	d ₂ (mm)	Min. inner diameter (mm)	Effective cross-sectional area (mm ²)	Weight (g)
EYB1/8-C1	1/8	29.0	16.6	11	11.5	9.0	8.0	7.7	3.2	3.0	—	—
EYB1/4-C1	1/4	40.3	24.7	16	16.2	12.2	12.5	13.0	4.2	5.0	10.5	10.0
EYB3/8-C1	3/8	50.6	35.0	20	19.5	17.5	17.5	18.0	4.2	9.0	24.0	24.0
EYB1/2-C1	1/2	60.4	42.0	23	22.7	21.0	21.0	21.5	4.2	11.0	46.5	33.0

Panel touch connector



●Millimeter size type

Product number	Applicable tube outer diameter (mm)	L (mm)	F Tube insertion length (mm)	H ₄ (mm)	t Max. panel thickness (mm)	T ₁ Recommended panel hole diameter (mm)	Washer outer diameter (mm)	Washer thickness (mm)	Min. inner diameter (mm)	Effective cross-sectional area (mm ²)	Weight (g)
EPC4-C1	4	32.7	14	17.0	7.5	13	24.0	2.5	3.0	3.5	5.0
EPC6-C1	6	34.5	15	19.0	9.5	15	28.0	2.5	5.0	12.5	7.0
EPC8-C1	8	36.6	16	22.0	10.0	17	30.0	3.0	7.0	28.0	9.0
EPC10-C1	10	42.4	19	27.0	14.0	21	37.0	3.0	9.0	45.0	16.0
EPC12-C1	12	44.4	20	30.0	16.0	23	39.0	3.0	11.0	67.0	67.0

●Inch size type

Product number	Applicable tube outer diameter (inch)	L (mm)	F Tube insertion length (mm)	H ₄ (mm)	t Max. panel thickness (mm)	T ₁ Recommended panel hole diameter (mm)	Washer outer diameter (mm)	Washer thickness (mm)	Min. inner diameter (mm)	Effective cross-sectional area (mm ²)	Weight (g)
EPC1/4-C1	1/4	36.4	16	19.0	9.5	15	28.0	2.5	5.0	12.5	7.0
EPC3/8-C1	3/8	44.0	20	27.0	14.0	21	37.0	3.0	9.0	45.0	16.0
EPC1/2-C1	1/2	48.5	23	30.0	16.0	23	39.0	3.0	11.0	67.0	67.0

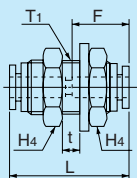

*Made to order

Tube
Clean tube
Processed tube
PushOne fitting
QuickSeal fitting
Clean fitting/Chemifit
Bamboo-shoot fitting
Control switch/Detachable series
Jig/Tool/Accessory
Technical information
Reference

Reducer



●Millimeter size type

Product number	Applicable tube outer diameter (mm)	D1 Insertion part diameter (mm)	L (mm)	L ₁₀ (mm)	F Tube insertion length (mm)	D (mm)	Min. inner diameter (mm)	Effective cross-sectional area (mm ²)	Weight (g)
ER4-6-C1	4	6	34.5	16.3	14	10.0	3.0	3.5	2.0
ER4-8-C1	4	8	32.0	16.8	14	10.0	3.0	3.5	2.0
ER6-8-C1	6	8	34.7	16.9	15	13.0	5.0	10.5	2.0
ER6-10-C1	6	10	35.6	19.6	15	13.0	5.0	10.5	3.0
ER8-10-C1	8	10	39.4	17.8	16	15.0	7.0	28.0	3.0
ER8-12-C1	8	12	38.3	15.2	16	15.0	7.0	28.0	4.0
ER10-12-C1	10	12	42.8	19.9	19	18.0	9.0	45.0	8.0

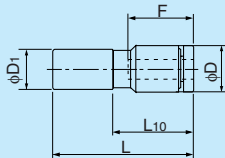

●Inch size type

Product number	Applicable tube outer diameter (inch)	D1 Insertion part diameter (inch)	L (mm)	L ₁₀ (mm)	F Tube insertion length (mm)	D (mm)	Min. inner diameter (mm)	Effective cross-sectional area (mm ²)	Weight (g)
ER1/4-3/8-C1	1/4	3/8	35.2	12.5	16	13.0	5.0	12.0	3.0

Manifold



●Inch size type

Product number	d ₁ Applicable tube outer diameter (inch)	d ₂ Applicable tube outer diameter (inch)	L (mm)	P ₁ (mm)	L _s (mm)	F ₁ Tube insertion length (mm)	F ₂ Tube insertion length (mm)	D ₁ (mm)	D ₂ (mm)	W (mm)	Weight (g)
EMA1/8-1/4-4S-C1	1/8	1/4	61.0	9.0	21.5	11	16	8.0	12.5	12.5	—

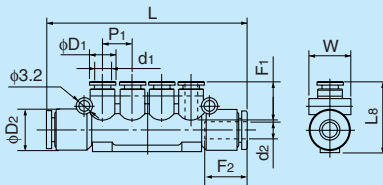

Blank plug



●Millimeter size type

Product number	D1 Insertion part diameter (mm)	L (mm)	L ₁ (mm)	D (mm)	Weight (g)
BC3-C1	3	22.0	11.5	5.0	0.5
BC4-C1	4	28.0	15.5	7.7	0.5
BC6-C1	6	28.0	16.0	9.7	0.8
BC8-C1	8	29.0	16.0	11.7	1.1
BC10-C1	10	32.0	17.7	14.0	1.6
BC12-C1	12	34.0	20.4	16.0	2.4

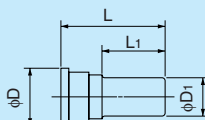

●Inch size type

Product number	D1 Insertion part diameter (inch)	L (mm)	L ₁ (mm)	D (mm)	Weight (g)
BC1/8-C1	1/8	26.0	13.5	7.7	—
BC1/4-C1	1/4	28.0	16.0	9.7	1.2
BC3/8-C1	3/8	32.0	17.7	14.0	2.5
BC1/2-C1	1/2	34.0	20.4	16.0	3.8

Tube

Clean tube

Processed tube

PushOne fitting

QuickSeal fitting

Clean fitting/ Chemifit

Bamboo-shoot fitting

Control switch/ Detachable series

Jig/Tool/ Accessory

Technical information

Reference

Chemifit® C1S Series

PushOne® fitting for clean air, pure water and chemical liquids

Features

- **No-oil processed**
Assembled after cleaning each part in a clean room. No oil or fat are used in the sealing materials.
- **PushOne® connection of tube**
The tubes can be connected without using a jig or tools.
- **SUS304 thread**
High thread strength
- **Double clean package**
Each fitting is packed in a clean room and put in a zipper sealed bag.
- **Easy directional setting of tube.**

Cross-sectional structure diagram

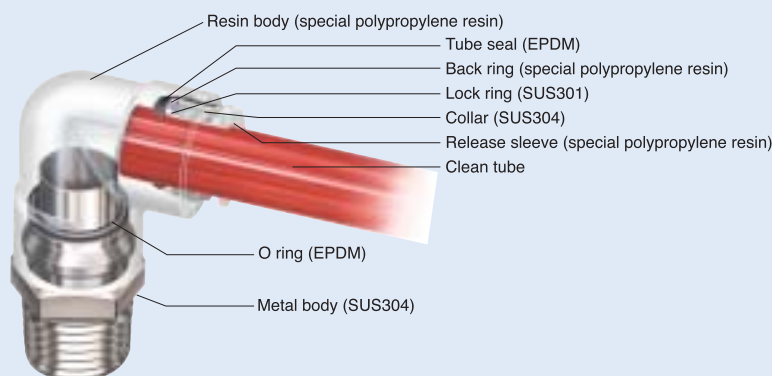

Product number example

EL 6 - R1/4 - C1S

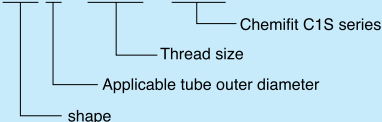

Distinction of millimeter/inch sizes

- The tube size is shown on the release sleeve.

Applicable tube

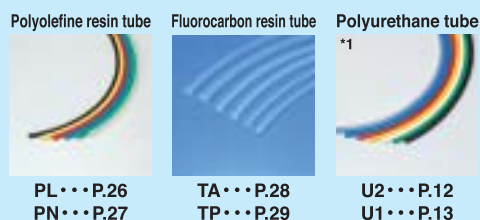

Allied products and product introduction



Reference

Instruction manual.....P.184
Chemical resistance
specification table.....P.207
Effective cross-sectional
areaP.176
Negative-pressure
performance list.....P.177



Operating fluid, working temperature range

Operating fluid	Working temperature range
Air (clean air)	-20°C~+80°C
Water (pure water)	0°C~+80°C

- ☞ Contact us for various chemical liquids.
- ☞ See "Combination List of Tube and Fitting" on page 8.

Pressure condition

Maximum working pressure: 0.7MPa(at20°C)
Negative pressure performance: -99.975kPa

Relation between the working temperature and the maximum working pressure

Maximum working pressure varies with working temperature (environmental temperature). For use at an abnormal temperature, always check the maximum working pressure change in the graph below and keep pressure within the range.

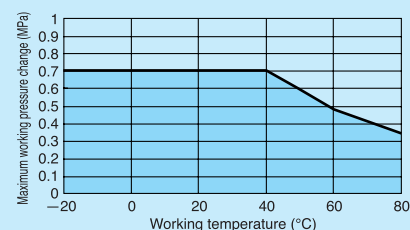

Handling instructions

- ⚠ **Caution** When the working conditions of tubes and fittings differ, use them under the lower specified conditions.
- ⚠ **Caution** When water is used as the operating fluid, do not allow it to freeze.
- ⚠ **Caution** Do not bend the pipe sharply near the tube insertion port (sleeve end) of the fitting. Keep the tube straight for twice as long as the tube diameter from the insertion port.

- ☞ See page34 for the common handling instructions for tube fittings.

(*1) Combinatory use of U2 or U1 tube and Chemifit C1S series mixes general and clean type performances. When using them in a clean environment, pay attention to the clean level that could be lowered.

Chemifit® C1S Series

Shape list



See Chemifit C1 series for union type shape.

Tube

Clean tube

Processed tube

PushOne fitting

QuickSeal fitting

Clean fitting/ Chemifit

Bamboo-shoot fitting

Control switch/ Detachable series

Jig/Tool/ Accessory

Technical information

Reference

No-oil processing, Clean wrapping and packaging

● Ultrasonic cleaning with no oil or fat used for assembling in a clean room

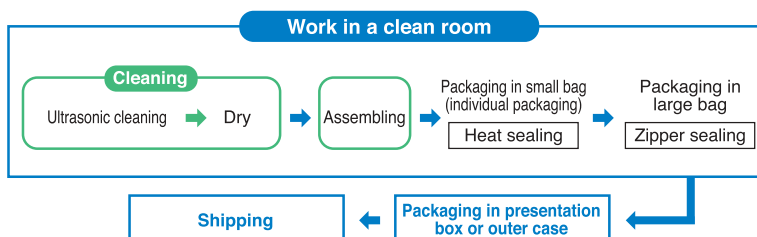

● High-barrier sheet packaging available

What is high-barrier sheet packaging?

In order to maintain the cleanliness of our products, no space for oxygen, water, or corrosive gas is allowed inside the package so a packaging bag with a high gas barrier is needed for protecting the content from these gases. To meet this requirement, Nitta provides high-barrier bags with a high gas barrier performance also for nitrogen sealing or atmospheric sealing.



- The packaging bags that Nitta uses have the highest gas barrier performance among clear bags.
- The bags do not contain halogen, etc, for safe burning.

Connector

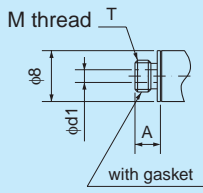
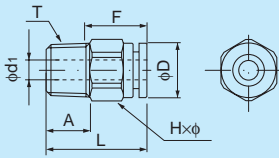

●Millimeter size type

Product number	Applicable tube outer diameter (mm)	T Thread size (R,M)	L (mm)	A (mm)	F Tube insertion length (mm)	H×φ Width across flat (mm)	D (mm)	d ₁ (mm)	Effective cross-sectional area (mm ²)	Weight (g)
EC3-M5-C1S	3	M5×0.8	13.0	3.0	11	5.5×6.0	5.6	1.5	2.0	2.0
EC4-M5-C1S	4	M5×0.8	20.5	4.0	14	10.0×11.0	10.0	2.0	3.0	6.0
EC4-R1/8-C1S	4	R1/8	20.5	8.0	14	10.0×11.0	10.0	2.5	4.0	7.0
EC6-M5-C1S	6	M5×0.8	24.3	4.0	15	12.0×13.0	12.0	2.0	3.5	9.0
EC6-R1/8-C1S	6	R1/8	22.7	8.0	15	12.0×13.0	12.0	4.0	10.5	9.0
EC6-R1/4-C1S	6	R1/4	25.7	11.0	15	14.0×15.4	12.0	4.0	10.5	18.0
EC8-R1/8-C1S	8	R1/8	29.3	9.0	16	14.0×15.4	13.9	6.0	20.0	14.0
EC8-R1/4-C1S	8	R1/4	26.3	11.0	16	14.0×15.4	13.9	6.0	25.0	16.0
EC10-R1/4-C1S	10	R1/4	29.2	11.0	19	17.0×18.5	17.0	8.0	40.0	21.0
EC10-R3/8-C1S	10	R3/8	30.2	12.0	19	17.0×18.5	17.0	8.0	40.0	29.0
EC12-R3/8-C1S	12	R3/8	31.1	12.0	20	19.0×21.0	19.0	10.0	50.0	31.0
EC12-R1/2-C1S	12	R1/2	34.1	15.0	20	22.0×24.5	19.0	10.0	50.0	58.0

●Inch size type

Product number	Applicable tube outer diameter (inch)	T Thread size (M)	L (mm)	A (mm)	F Tube insertion length (mm)	H×φ Width across flat (mm)	D (mm)	d ₁ (mm)	Effective cross-sectional area (mm ²)	Weight (g)
EC1/8-M5-C1S	1/8	M5×0.8	16.0	3.5	11	8.0×8.8	8	2.5	—	—

Internal connector

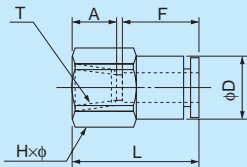

●Millimeter size type

Product number	Applicable tube outer diameter (mm)	T Thread size (R)	L (mm)	A (mm)	F Tube insertion length (mm)	H×φ Width across flat (mm)	D (mm)	Effective cross-sectional area (mm ²)	Weight (g)
EFC4-R1/8-C1S	4	R1/8	25.0	8.7	14	14.0×15.4	10.0	4.0	16.0
EFC6-R1/8-C1S	6	R1/8	26.1	8.7	15	14.0×15.4	12.0	10.5	17.0
EFC6-R1/4-C1S	6	R1/4	30.6	13.0	15	17.0×18.5	12.0	10.5	26.0
EFC8-R1/4-C1S	8	R1/4	32.0	13.0	16	17.0×18.5	14.0	25.0	28.0
EFC10-R1/4-C1S	10	R1/4	35.0	13.0	19	17.0×18.5	17.0	40.0	34.0
EFC10-R3/8-C1S	10	R3/8	35.5	13.5	19	22.0×24.5	17.0	40.0	50.0
EFC10-R1/2-C1S	10	R1/2	39.5	17.5	19	24.0×26.5	17.0	40.0	56.0
EFC12-R3/8-C1S	12	R3/8	36.4	13.5	20	22.0×24.5	19.0	50.0	50.0
EFC12-R1/2-C1S	12	R1/2	40.4	17.5	20	24.0×26.5	19.0	50.0	58.0

90 degree elbow

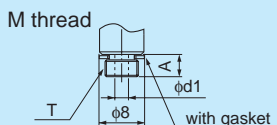
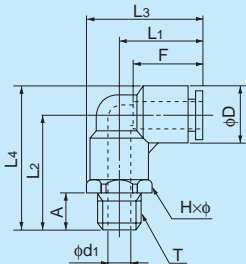

●Millimeter size type

Product number	Applicable tube outer diameter (mm)	T Thread size (R,M)	L ₁ (mm)	L ₂ (mm)	L ₃ (mm)	L ₄ (mm)	A (mm)	F Tube insertion length (mm)	H×φ Width across flat (mm)	D (mm)	d ₁ (mm)	Min. inner diameter (mm)	Effective cross-sectional area (mm ²)	Weight (g)
EL3-M5-C1S	3	M5×0.8	12.5	13.0	16.4	16.2	3.5	11	7.0×7.7	6.3	2.5	1.5	1.5	—
EL4-M5-C1S	4	M5×0.8	17.7	20.5	23.2	25.5	4.0	14	10.0×11.0	9.7	2.0	2.0	3.0	7.0
EL4-R1/8-C1S	4	R1/8	17.7	22.5	23.2	27.5	8.0	14	10.0×11.0	9.7	5.0	3.0	4.0	9.0
EL6-M5-C1S	6	M5×0.8	18.9	22.5	25.4	29.0	4.0	15	12.0×13.0	12.5	2.0	2.0	3.5	10.0
EL6-R1/8-C1S	6	R1/8	18.9	25.0	25.4	31.5	8.0	15	12.0×13.0	12.5	5.0	5.0	12.0	18.0
EL6-R1/4-C1S	6	R1/4	18.9	29.0	26.6	35.5	11.0	15	14.0×15.4	12.5	7.0	5.0	12.0	18.0
EL8-R1/8-C1S	8	R1/8	21.1	27.0	28.8	34.5	8.0	16	14.0×15.4	14.5	6.5	6.5	18.5	15.0
EL8-R1/4-C1S	8	R1/4	21.1	30.0	28.8	37.5	12.0	16	14.0×15.4	14.5	6.5	6.5	23.0	20.0
EL10-R1/4-C1S	10	R1/4	25.0	37.0	34.3	46.0	12.0	19	17.0×18.5	17.5	8.0	8.0	34.5	27.0
EL10-R3/8-C1S	10	R3/8	25.0	37.0	34.3	46.0	14.0	19	17.0×18.5	17.5	9.0	8.0	37.0	33.0
EL12-R3/8-C1S	12	R3/8	26.7	38.5	37.2	48.5	14.0	20	19.0×21.0	20.0	10.0	9.5	43.0	39.0
EL12-R1/2-C1S	12	R1/2	26.7	41.5	38.7	51.5	16.0	20	22.0×24.0	20.0	12.0	9.5	43.0	56.0

●Inch size type

Product number	Applicable tube outer diameter (inch)	T Thread size (M)	L ₁ (mm)	L ₂ (mm)	L ₃ (mm)	L ₄ (mm)	A (mm)	F Tube insertion length (mm)	H×φ Width across flat (mm)	D (mm)	d ₁ (mm)	Min. inner diameter (mm)	Effective cross-sectional area (mm ²)	Weight (g)
EL1/8-M5-C1S	1/8	M5×0.8	14.5	13.0	19	17	3.5	11	8.0×8.8	8	2.5	2.5	—	—

Tube
Clean tube
Processed tube
PushOne fitting
QuickSeal fitting
Clean fitting/ Chemifit
Bamboo-shoot fitting
Control switch/ Detachable series
Jig/Tool/ Accessory
Technical information
Reference

Tee

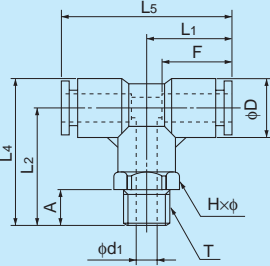

M thread

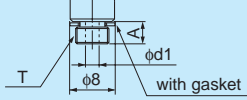

●Millimeter size type

Product number	Applicable tube outer diameter (mm)	T Thread size (R,M)	L ₁ (mm)	L ₂ (mm)	L ₄ (mm)	L ₅ (mm)	A (mm)	F Tube insertion length (mm)	H×φ Width across flat (mm)	D (mm)	d ₁ (mm)	Min. inner diameter (mm)	Effective cross-sectional area (mm ²)	Weight (g)
ET3-M5-C1S	3	M5×0.8	12.5	13.0	16.0	25.0	3.5	11	7.0×7.7	6.3	2.5	1.5	1.5	2.0
ET4-M5-C1S	4	M5×0.8	17.7	20.2	25.1	35.3	4.0	14	10.0×11.0	10.0	2.0	2.0	3.0	8.0
* ET4-R1/8-C1S	4	R1/8	17.7	23.7	28.6	35.3	9.0	14	10.0×11.0	10.0	5.0	3.0	4.0	10.0
ET6-M5-C1S	6	M5×0.8	18.9	22.7	29.0	37.9	4.0	15	12.0×13.0	13.0	2.0	2.0	3.5	12.0
* ET6-R1/8-C1S	6	R1/8	18.9	26.2	32.5	37.9	9.0	15	12.0×13.0	13.0	4.5	4.5	12.0	14.0
* ET6-R1/4-C1S	6	R1/4	18.9	30.2	36.5	37.9	12.0	15	14.0×15.4	13.0	7.0	4.5	12.0	21.0
* ET8-R1/8-C1S	8	R1/8	21.1	29.2	36.5	42.2	9.0	16	14.0×15.4	15.0	6.0	6.0	18.5	18.0
* ET8-R1/4-C1S	8	R1/4	21.1	31.2	38.5	42.2	12.0	16	14.0×15.4	15.0	6.5	6.5	23.0	24.0
* ET10-R1/4-C1S	10	R1/4	25.0	37.2	46.0	50.0	12.0	19	17.0×18.5	18.0	8.0	8.0	34.5	34.0
* ET10-R3/8-C1S	10	R3/8	25.0	37.2	46.0	50.0	14.0	19	17.0×18.5	18.0	9.0	8.0	37.0	39.0
* ET12-R3/8-C1S	12	R3/8	26.7	38.7	48.8	53.4	14.0	20	19.0×21.0	20.5	10.0	10.0	43.0	48.0
* ET12-R1/2-C1S	12	R1/2	26.7	41.7	51.8	53.4	16.0	20	22.0×24.0	20.5	12.0	9.5	43.0	65.0

*Made to order

●Inch size type

Product number	Applicable tube outer diameter (inch)	T Thread size (M)	L ₁ (mm)	L ₂ (mm)	L ₄ (mm)	L ₅ (mm)	A (mm)	F Tube insertion length (mm)	H×φ Width across flat (mm)	D (mm)	d ₁ (mm)	Min. inner diameter (mm)	Effective cross-sectional area (mm ²)	Weight (g)
ET1/8-M5-C1S	1/8	M5×0.8	17.6	26.2	32.5	35.2	9.0	15	12.0×13.0	13.0	4.5	4.5	13.0	5.0

Service tee

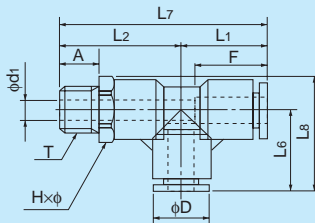

M thread

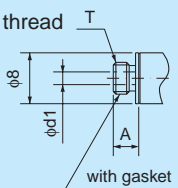

●Millimeter size type

Product number	Applicable tube outer diameter (mm)	T Thread size (R,M)	L ₁ (mm)	L ₂ (mm)	L ₆ (mm)	L ₇ (mm)	L ₈ (mm)	A (mm)	F Tube insertion length (mm)	H×φ Width across flat (mm)	D (mm)	d ₁ (mm)	Min. inner diameter (mm)	Effective cross-sectional area (mm ²)	Weight (g)
EST4-M5-C1S	4	M5×0.8	17.7	20.2	17.7	37.9	23.2	4.0	14	10.0×11.0	10.0	2.0	2.0	3.0	8.0
* EST4-R1/8-C1S	4	R1/8	17.7	23.7	17.7	40.4	23.2	9.0	14	10.0×11.0	10.0	5.0	3.0	4.0	10.0
EST6-M5-C1S	6	M5×0.8	18.9	27.7	18.9	41.6	25.4	4.0	15	12.0×13.0	13.0	2.0	2.0	3.5	12.0
* EST6-R1/8-C1S	6	R1/8	18.9	26.2	18.9	44.1	25.4	9.0	15	12.0×13.0	13.0	4.5	4.5	12.0	14.0
* EST6-R1/4-C1S	6	R1/4	18.9	30.2	18.9	48.1	26.6	12.0	15	14.0×15.4	13.0	7.0	4.5	12.0	21.0
* EST8-R1/8-C1S	8	R1/8	21.1	29.2	21.1	48.3	28.8	9.0	16	14.0×15.4	15.0	6.0	6.0	18.5	18.0
* EST8-R1/4-C1S	8	R1/4	21.1	31.2	21.1	52.3	28.8	12.0	16	14.0×15.4	15.0	6.5	6.5	23.0	24.0
* EST10-R1/4-C1S	10	R1/4	25.0	37.2	25.0	62.2	34.3	12.0	19	17.0×18.5	18.0	8.0	8.0	34.5	34.0
* EST10-R3/8-C1S	10	R3/8	25.0	37.2	25.0	62.2	34.3	14.0	19	17.0×18.5	18.0	9.0	8.0	37.0	40.0
* EST12-R3/8-C1S	12	R3/8	26.7	38.7	26.7	65.4	37.2	14.0	20	19.0×21.0	20.5	10.0	10	43.0	48.0
* EST12-R1/2-C1S	12	R1/2	26.7	41.7	26.7	68.4	38.7	16.0	20	22.0×24.0	20.5	12.0	9.5	43.0	65.0

*Made to order

Tube

Clean tube

Processed tube

PushOne fitting

QuickSeal fitting

Clean fitting/ Chemifit

Bamboo-shoot fitting

Control switch/ Detachable series

Jig/Tool/ Accessory

Technical information

Reference

Y joint



●Millimeter size type

Product number	Applicable tube outer diameter (mm)	Thread size (R,M)	L (mm)	L ₁₁ (mm)	A (mm)	F Tube insertion length (mm)	H×φ Width across flat (mm)	P ₃ (mm)	P ₄ (mm)	W (mm)	D (mm)	d ₁ (mm)	d ₂ (mm)	Min. inner diameter (mm)	Effective cross-sectional area (mm ²)	Weight (g)
EY3-M5-C1S	3	M5×0.8	26.2	13.0	3.5	11	7.0×7.7	10.9	7.0	6.0	6.3	2.5	2.0	2.0	—	—
EY4-M5-C1S	4	M5×0.8	40.9	20.7	4.0	14	10.0×11.0	13.9	11.0	9.7	10.0	2.0	3.2	2.0	2.0	9.0
* EY4-R1/8-C1S	4	R1/8	40.9	20.7	9.0	14	10.0×11.0	13.9	11.0	9.7	10.0	5.0	3.2	3.0	3.5	11.0
EY6-M5-C1S	6	M5×0.8	44.2	20.7	4.0	15	12.0×13.0	15.2	12.2	12.5	13.0	2.0	4.2	2.0	2.5	12.0
* EY6-R1/8-C1S	6	R1/8	46.2	24.7	9.0	15	12.0×13.0	15.2	12.2	12.5	13.0	4.5	4.2	4.5	9.0	15.0
* EY6-R1/4-C1S	6	R1/4	48.6	24.7	12.0	15	14.0×15.4	15.2	12.2	12.5	13.0	7.0	4.2	4.5	9.0	22.0
* EY8-R1/8-C1S	8	R1/8	51.7	28.7	9.0	16	14.0×15.4	16.8	14.2	14.5	15.0	6.0	4.2	6.0	17.5	20.0
* EY8-R1/4-C1S	8	R1/4	51.7	28.7	12.0	16	14.0×15.4	16.8	14.2	14.5	15.0	6.5	4.2	6.5	20.0	25.0
* EY10-R1/4-C1S	10	R1/4	59.7	35.0	12.0	19	17.0×18.5	18.7	17.5	17.5	18.0	8.0	4.2	8.0	27.5	33.0
* EY10-R3/8-C1S	10	R3/8	59.7	35.0	14.0	19	17.0×18.5	18.7	17.5	17.5	18.0	9.0	4.2	8.0	28.0	41.0
* EY12-R3/8-C1S	12	R3/8	67.2	40.0	14.0	20	19.0×21.0	20.7	20.0	20.0	20.5	10.0	4.2	10	40.0	52.0
* EY12-R1/2-C1S	12	R1/2	70.2	40.0	16.0	20	22.0×24.0	20.7	20.0	20.0	20.5	12.0	4.2	9.5	40.0	70.0

*Made to order

●Inch size type

Product number	Applicable tube outer diameter (inch)	Thread size (M)	L (mm)	L ₁₁ (mm)	A (mm)	F Tube insertion length (mm)	H×φ Width across flat (mm)	P ₃ (mm)	P ₄ (mm)	W (mm)	D (mm)	d ₁ (mm)	d ₂ (mm)	Min. inner diameter (mm)	Effective cross-sectional area (mm ²)	Weight (g)
EY1/8-M5-C1S	1/8	M5×0.8	27.0	17.0	3.5	11	8.0×8.8	11.5	9.0	8.0	8.0	2.5	3.2	2.5	—	—

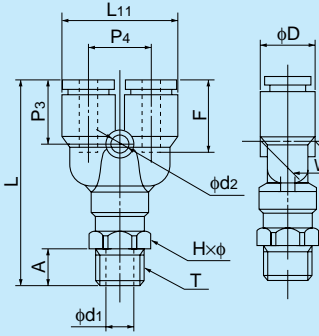

M thread

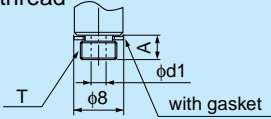

Panel touch connector

●Millimeter size type

Product number	Applicable tube outer diameter (mm)	L (mm)	F Tube insertion length (mm)	H ₄ (mm)	T ₁ Recommended panel hole diameter (mm)	t Max. panel thickness (mm)	Washer outer diameter (mm)	Washer thickness (mm)	Min. inner diameter (mm)	Effective cross-sectional area (mm ²)	Weight (g)
EPC3-C1S	3	24.8	11	12.0	9.0	4.5	15.0	1.6	2.0	2.5	—

●Inch size type

Product number	Applicable tube outer diameter (inch)	L (mm)	F Tube insertion length (mm)	H ₄ (mm)	T ₁ Recommended panel hole diameter (mm)	t Max. panel thickness (mm)	Washer outer diameter (mm)	Washer thickness (mm)	Min. inner diameter (mm)	Effective cross-sectional area (mm ²)	Weight (g)
EPC1/8-C1S	1/8	25.5	11	14.0	11.0	5.5	18.0	1.6	2.5	—	—

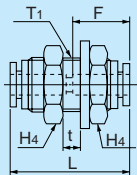

Tube

Clean tube

Processed tube

PushOne fitting

QuickSeal fitting

Clean fitting/ Chemifit

Bamboo-shoot fitting

Control switch/ Detachable series

Jig/Tool/ Accessory

Technical information

Reference

Reference

Technical information

Jig/Tool/
Accessory

Control switch/
Detachable
series

Bambooo-
shoot fitting

Clean fitting/
Chemifit

QuickSeal
fitting

PushOne
fitting

Processed
tube

Clean tube

Tube

Chemifit® CSA Series

Threaded fitting for clean air, pure water and chemical liquids

Features

- **SUS316 threaded fitting**
Consisting of two parts, assembly nut and fitting body, with Nitta's original mechanism.
- **Highly improved workability for attaching and detaching a tube**
The integrated structure of the fitting body and the insertion part. The assembly nut has a built-in sleeve. Both the fitting body and the assembly nut are reusable.
- **Uniform workability for connecting tube.**
Tube connection is completed when the assembly nut reaches the fitting body. No need for torque control or special tools.
- **No rotation of tube when the tube is attached**
A sleeve inside the assembly nut can rotate. Hence the inserted tube does not rotate together.
- **No-oil processed**
Assembled after cleaning each part in a clean room.
- **High sealing performance**
Nitta's original sealing mechanism achieves high durability against degradation of sealing performance due to cold-hot cycle.
- **No need for additional tightening of nut**
The structure with less stress relaxation ensures high sealing performance for a long period of time and the nut does not need to be tightened at maintenance.
- **Highly smooth inner surface and R sphere surface processing on elbow crossing**
The surface roughness is below Ra3.2. The corner of the elbow is sphere surface processed, which reduces liquid and detergent remains.
- **Silver plated thread inside assembly nut**
It prevents seizing of the fitting body and the assembly nut when a tube is tightly inserted.

Cross-sectional structure diagram

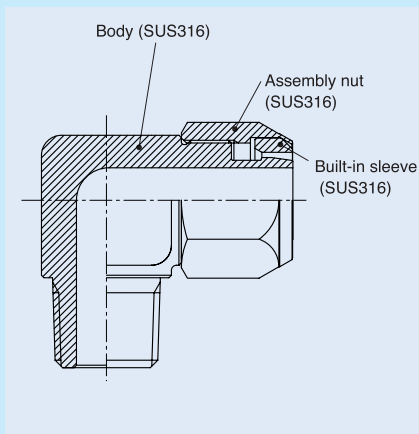

Sealing mechanism

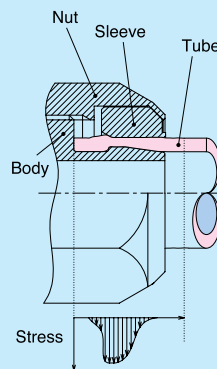



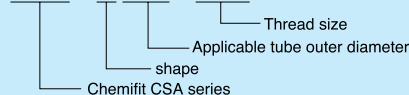

Nitta's original sealing mechanism achieves high durability against degradation of sealing performance due to cold-hot cycle. The mechanism does not cause stress relaxation, ensuring sealing performance for a long period of time. Also, the nut does not need to be tightened at maintenance.

Product number example

CSA - C 6x4 - R1/4

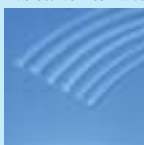
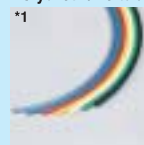

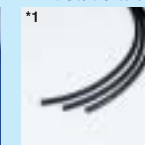
Applicable tube

Polyolefine resin tube	Fluorocarbon resin tube	Polyurethane tube	Flexible fluorocarbon resin bilayer tube	Polybutene tube	Antistatic tube	Polyurethane processed tube
						
PL...P.26 PN...P.27	TA...P.28	U2...P.12 U1...P.13 U5...P.14	TES...P.18	PB...P.25	UE...P.23	UC...P.30 USC...P.30 UMC...P.30 UML...P.31

(*1) Combinatory use of U2, U1, U5, TES, PB, UE or polyurethane processed tube and Chemifit CSA series mixes general and clean type performances. When using them in a clean environment, pay attention to the clean level that could be lowered.

Patent pending



Operating fluid, working temperature range

Operating fluid	Working temperature range
Air (clean air)	-65°C~+260°C
Water (pure water)	0°C~+100°C

- ☞ Contact us for various chemical liquids.
- ☞ See "Combination List of Tube and Fitting" on page 8.

Pressure condition

Maximum working pressure: 5.0MPa
Negative pressure performance: -101.294kPa

Handling instructions

- ⚠ **Caution** When the working conditions of tubes and fittings differ, use them under the lower specified conditions.
- ⚠ **Caution** When water is used as the operating fluid, do not allow it to freeze.
- ⚠ **Caution** Do not bend the pipe sharply near the tube insertion port of the fitting. Keep the tube straight for twice as long as the tube diameter from the insertion port.
- ☞ See page34 for the common handling instructions for tube fittings.

Distinction of millimeter/inch sizes

Assembly nut

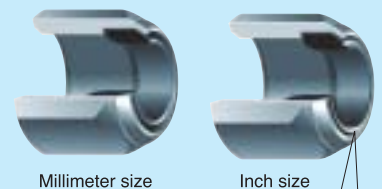

The inch size type has a boss at the sleeve end to distinguish from millimeter size type.

Reference

Instruction manual.....P.186
Chemical resistance specification table...P.207
Effective cross-sectional area.....P.176
Negative-pressure performance list...P.177

Chemifit® CSA Series

Shape list



Tube

Clean tube

Processed tube

PushOne fitting

QuickSeal fitting

Clean fitting/ Chemifit

Bamboo-shoot fitting

Control switch/ Detachable series

Jig/Tool/ Accessory

Technical information

Reference

No-oil processing, Clean wrapping and packaging

● Ultrasonic cleaning with no oil or fat used for assembling in a clean room

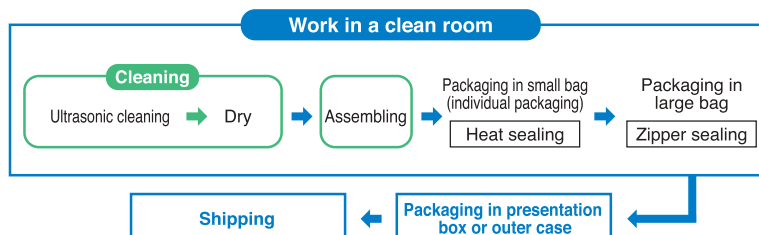

● High-barrier sheet packaging available

What is high-barrier sheet packaging?

In order to maintain the cleanliness of our products, no space for oxygen, water, or corrosive gas is allowed inside the package and a packaging bag with a high gas barrier is needed for protecting the content from these gases. To meet this requirement, Nitta provides high-barrier bags with a high gas barrier performance also for nitrogen sealing or atmospheric sealing.



- The packaging bags that Nitta uses have the highest gas barrier performance among clear bags.
- The bags do not contain halogen, etc., for safe burning.

Connector

●Millimeter size type

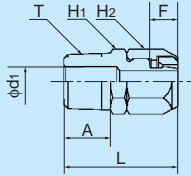

Product number	Applicable tube outer/inner diameters (mm)	T Thread size (R)	L (mm)	A (mm)	F Tube insertion length (mm)	H ₁ Width across flat (mm)	H ₂ Width across flat (mm)	d ₁ (mm)	Min. inner diameter (mm)	Effective cross-sectional area (mm ²)	Weight (g)
CSA-C4×2-R1/8	4×2	R1/8	24.0	9.0	5.5	10.0	10.0	5.0	1.3	1.5	11.0
CSA-C4×2-R1/4	4×2	R1/4	29.0	14.0	5.5	14.0	10.0	7.0	1.3	1.5	19.0
CSA-C6×4-R1/8	6×4	R1/8	26.5	9.0	7	12.0	12.0	5.0	3.0	7.0	17.0
CSA-C6×4-R1/4	6×4	R1/4	31.5	14.0	7	14.0	12.0	7.0	3.0	7.0	24.0
CSA-C6×4-R3/8	6×4	R3/8	31.5	14.0	7	17.0	12.0	9.0	3.0	7.0	33.0
* CSA-C8×5-R1/8	8×5	R1/8	28.0	9.0	7.5	14.0	14.0	4.5	4.3	13.0	23.0
* CSA-C8×5-R1/4	8×5	R1/4	33.0	14.0	7.5	14.0	14.0	7.0	4.3	13.0	28.0
* CSA-C8×5-R3/8	8×5	R3/8	33.0	14.0	7.5	17.0	14.0	9.0	4.3	13.0	37.0
CSA-C8×6-R1/8	8×6	R1/8	28.0	9.0	7.5	14.0	14.0	5.0	5.0	18.0	24.0
CSA-C8×6-R1/4	8×6	R1/4	33.0	14.0	7.5	14.0	14.0	7.0	5.0	18.0	29.0
CSA-C8×6-R3/8	8×6	R3/8	33.0	14.0	7.5	17.0	14.0	9.0	5.0	18.0	38.0
CSA-C8×6-R1/2	8×6	R1/2	37.0	18.0	7.5	22.0	14.0	12.0	5.0	18.0	60.0
* CSA-C10×6.5-R1/4	10×6.5	R1/4	35.0	14.0	8.5	17.0	17.0	7.0	5.5	22.0	39.0
CSA-C10×8-R1/4	10×8	R1/4	34.5	14.0	8.5	17.0	17.0	7.0	6.5	31.0	40.0
CSA-C10×8-R3/8	10×8	R3/8	34.5	14.0	8.5	17.0	17.0	9.0	6.5	31.0	46.0
CSA-C10×8-R1/2	10×8	R1/2	38.5	18.0	8.5	22.0	17.0	12.0	6.5	31.0	65.0
* CSA-C12×8-R1/4	12×8	R1/4	36.5	14.0	10	17.0	19.0	7.0	7.0	36.0	46.0
CSA-C12×9-R1/4	12×9	R1/4	36.5	14.0	10	17.0	19.0	7.5	7.5	41.0	46.0
CSA-C12×9-R3/8	12×9	R3/8	36.5	14.0	10	17.0	19.0	9.0	7.5	41.0	53.0
CSA-C12×9-R1/2	12×9	R1/2	40.5	18.0	10	22.0	19.0	12.0	7.5	41.0	72.0
CSA-C12×10-R1/4	12×10	R1/4	36.5	14.0	10	17.0	19.0	7.5	7.5	42.5	45.0
CSA-C12×10-R3/8	12×10	R3/8	36.5	14.0	10	17.0	19.0	9.0	8.5	52.5	51.0
CSA-C12×10-R1/2	12×10	R1/2	40.5	18.0	10	22.0	19.0	12.0	8.5	52.5	71.0
* CSA-C19×16-R1/2	19×16	R1/2	45.5	18.0	12.5	27.0	27.0	12.0	12.0	106.0	115.0
* CSA-C19×16-R3/4	19×16	R3/4	47.5	20.0	12.5	29.0	27.0	13.0	13.0	125.0	—

*Made to order

●Inch size type

Product number	Applicable tube outer/inner diameters (mm)	T Thread size (R)	L (mm)	A (mm)	F Tube insertion length (mm)	H ₁ Width across flat (mm)	H ₂ Width across flat (mm)	d ₁ (mm)	Min. inner diameter (mm)	Effective cross-sectional area (mm ²)	Weight (g)
CSA-C1/4-R1/8	6.35×4.75	R1/8	26.5	9.0	7	12.0	12.0	5.0	3.5	9.0	17.0
CSA-C1/4-R1/4	6.35×4.75	R1/4	31.5	14.0	7	14.0	12.0	7.0	3.5	9.0	24.0
* CSA-C1/4-R3/8	6.35×4.75	R3/8	31.0	14.0	6.5	17.0	12.0	9.0	3.5	9.0	—
CSA-C3/8-R1/4	9.53×6.99	R1/4	34.5	14.0	8.5	17.0	17.0	7.0	5.8	25.5	41.0
CSA-C3/8-R3/8	9.53×6.99	R3/8	34.5	14.0	9	17.0	17.0	9.0	5.8	25.5	46.0
* CSA-C3/8-R1/2	9.53×6.99	R1/2	39.0	18.0	9	22.0	17.0	12.0	5.8	22.0	—
* CSA-C1/2-R1/4	12.70×9.56	R1/4	38.0	14.0	10.5	19.0	22.0	7.0	7.0	—	—
CSA-C1/2-R3/8	12.70×9.56	R3/8	38.0	14.0	10.5	19.0	22.0	9.0	8.2	51.0	63.0
CSA-C1/2-R1/2	12.70×9.56	R1/2	42.0	18.0	10.5	22.0	22.0	12.0	8.2	51.0	80.0

*Made to order

Internal connector

●Millimeter size type

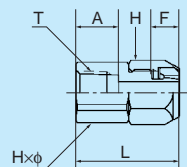

Product number	Applicable tube outer/inner diameters (mm)	T Thread size (R)	L (mm)	A (mm)	F Tube insertion length (mm)	H Width across flat (mm)	H×φ Width across flat (mm)	Min. inner diameter (mm)	Effective cross-sectional area (mm ²)	Weight (g)
CSA-FC6×4-R1/8	6×4	R1/8	24.5	8.7	7	12.0	14.0×15.4	3.0	6.0	20.0
CSA-FC8×6-R1/4	8×6	R1/4	30.0	13.0	7.5	14.0	17.0×18.5	5.0	18.0	33.0
CSA-FC10×8-R1/4	10×8	R1/4	31.5	13.0	8.5	17.0	17.0×18.5	6.5	31.0	40.0

Tube
Clean tube
Processed tube
PushOne fitting
QuickSeal fitting
Clean fitting/ Chemifit
Bamboo-shoot fitting
Control switch/ Detachable series
Jig/Tool/ Accessory
Technical information
Reference

90 degree elbow

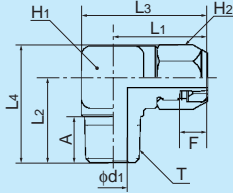

●Millimeter size type

Product number	Applicable tube outer-inner diameters (mm)	T Thread size (R)	L1 (mm)	L2 (mm)	L3 (mm)	L4 (mm)	A (mm)	F Tube insertion length (mm)	H1 Width across flat (mm)	H2 Width across flat (mm)	d1 (mm)	Min. inner diameter (mm)	Effective cross-sectional area (mm ²)	Weight (g)
CSA-L6×4-R1/8	6×4	R1/8	23.5	18.0	30.5	25.0	9.0	7	14.0	12.0	5.0	3.0	6.0	40.0
CSA-L6×4-R1/4	6×4	R1/4	23.5	23.0	30.5	30.0	14.0	7	14.0	12.0	7.0	3.0	6.0	44.0
CSA-L6×4-R3/8	6×4	R3/8	26.0	26.0	35.5	35.5	14.0	7	19.0	12.0	9.0	3.0	6.0	87.0
CSA-L8×5-R1/4	8×5	R1/4	25.0	23.0	32.0	31.0	14.0	7.5	14.0	19.0	7.0	4.3	—	46.0
CSA-L8×6-R1/8	8×6	R1/8	25.0	19.0	32.0	27.0	9.0	7.5	14.0	14.0	5.0	5.0	14.0	45.0
CSA-L8×6-R1/4	8×6	R1/4	25.0	23.0	32.0	32.0	14.0	7.5	14.0	14.0	7.0	5.0	15.5	48.0
CSA-L8×6-R3/8	8×6	R3/8	27.5	26.0	37.0	35.5	14.0	7.5	19.0	14.0	9.0	5.0	16.0	91.0
CSA-L8×6-R1/2	8×6	R1/2	29.0	30.0	40.0	41.0	18.0	7.5	22.0	14.0	12.0	5.0	—	—
CSA-L10×8-R1/4	10×8	R1/4	29.0	26.0	38.5	36.0	14.0	8.5	19.0	14.0	7.0	6.5	25.0	94.0
CSA-L10×8-R3/8	10×8	R3/8	29.0	26.0	38.5	36.0	14.0	8.5	19.0	17.0	9.0	6.5	27.5	98.0
CSA-L10×8-R1/2	10×8	R1/2	30.5	30.0	41.5	40.0	18.0	8.5	22.0	17.0	12.0	6.5	28.0	137.0
CSA-L12×8-R1/4	12×8	R1/4	31.0	26.0	40.5	37.0	14.0	10	19.0	17.0	7.0	7.0	30.5	101.0
CSA-L12×8-R1/2	12×8	R1/2	32.5	30.0	43.5	41.0	18.0	10	22.0	19.0	12.0	7.0	—	144.0
CSA-L12×9-R1/4	12×9	R1/4	31.0	26.0	40.5	37.0	14.0	10	19.0	19.0	7.0	7.0	30.5	100.0
CSA-L12×9-R3/8	12×9	R3/8	31.0	26.0	40.5	37.0	14.0	10	19.0	19.0	9.0	7.5	35.5	104.0
CSA-L12×9-R1/2	12×9	R1/2	32.5	30.0	43.5	41.0	18.0	10	22.0	19.0	12.0	7.5	37.0	143.0
CSA-L12×10-R1/4	12×10	R1/4	31.0	26.0	40.5	37.0	14.0	10	19.0	19.0	7.0	7.0	33.0	98.0
CSA-L12×10-R3/8	12×10	R3/8	31.0	26.0	40.5	37.0	14.0	10	19.0	19.0	9.0	8.5	43.0	101.0
CSA-L12×10-R1/2	12×10	R1/2	32.5	30.0	43.5	41.0	18.0	10	22.0	19.0	12.0	8.5	47.0	140.0
CSA-L19×16-R3/8	19×16	R3/8	37.5	28.5	50.5	44.0	13.0	12.5	26.0	19.0	9.0	9.0	—	200.0
CSA-L19×16-R1/2	19×16	R1/2	37.5	33.5	50.5	49.0	18.0	12.5	26.0	27.0	12.0	12.0	—	—
CSA-L19×16-R3/4	19×16	R3/4	38.8	37.0	53.3	52.5	20.0	12.5	29.0	27.0	13.0	13.0	—	—

*Made to order

●Inch size type

Product number	Applicable tube outer-inner diameters (mm)	T Thread size (R)	L1 (mm)	L2 (mm)	L3 (mm)	L4 (mm)	A (mm)	F Tube insertion length (mm)	H1 Width across flat (mm)	H2 Width across flat (mm)	d1 (mm)	Min. inner diameter (mm)	Effective cross-sectional area (mm ²)	Weight (g)
CSA-L1/4-R1/8	6.35/4.75	R1/8	23.5	18.0	30.5	25.0	9.0	7	14.0	12.0	5.0	3.5	7.5	40.0
CSA-L1/4-R1/4	6.35/4.75	R1/4	23.5	23.0	30.5	30.0	14.0	7	14.0	12.0	7.0	3.5	7.5	44.0
CSA-L1/4-R3/8	6.35/4.75	R3/8	25.5	26.0	35.0	35.5	14.0	6.5	19.0	12.0	9.0	3.5	—	—
CSA-L3/8-R1/4	9.53/6.99	R1/4	29.0	26.0	38.5	36.0	14.0	8.5	19.0	17.0	7.0	5.8	20.5	95.0
CSA-L3/8-R3/8	9.53/6.99	R3/8	29.0	26.0	38.5	36.0	14.0	8.5	19.0	17.0	9.0	5.8	22.0	99.0
CSA-L3/8-R1/2	9.53/6.99	R1/2	31.0	30.0	42.0	41.0	18.0	9	22.0	17.0	12.0	5.8	—	—
CSA-L1/2-R1/4	12.70/9.56	R1/4	31.5	29.0	41.0	38.5	14.0	10.5	19.0	22.0	7.0	7.0	—	—
CSA-L1/2-R3/8	12.70/9.56	R3/8	32.0	29.0	41.5	42.0	14.0	10.5	19.0	22.0	9.0	8.2	41.0	110.0
CSA-L1/2-R1/2	12.70/9.56	R1/2	33.5	30.5	44.5	43.0	18.0	10.5	22.0	22.0	12.0	8.2	43.0	148.0

*Made to order

Tee

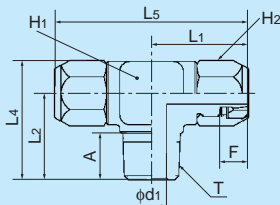

●Millimeter size type

Product number	Applicable tube outer-inner diameters (mm)	T Thread size (R)	L1 (mm)	L2 (mm)	L4 (mm)	L5 (mm)	A (mm)	F Tube insertion length (mm)	H1 Width across flat (mm)	H2 Width across flat (mm)	d1 (mm)	Min. inner diameter (mm)	Effective cross-sectional area (mm ²)	Weight (g)
CSA-T6×4-R1/8	6×4	R1/8	23.5	18.0	25.0	47.0	9.0	7	14.0	12.0	5.0	3.0	6.0	54.0
CSA-T6×4-R1/4	6×4	R1/4	23.5	23.0	30.0	47.0	14.0	7	14.0	12.0	7.0	3.0	6.0	58.0
CSA-T6×4-R3/8	6×4	R3/8	26.0	26.0	35.5	52.0	14.0	7	19.0	12.0	9.0	3.0	6.0	105.0
CSA-T8×6-R1/8	8×6	R1/8	25.0	19.0	27.0	50.0	9.0	7.5	14.0	14.0	5.0	5.0	14.0	62.0
CSA-T8×6-R1/4	8×6	R1/4	25.0	23.0	32.0	50.0	14.0	7.5	14.0	14.0	7.0	5.0	15.5	65.0
CSA-T8×6-R3/8	8×6	R3/8	27.5	26.0	35.5	55.0	14.0	7.5	19.0	14.0	9.0	5.0	16.0	112.0
CSA-T8×6-R1/2	8×6	R1/2	29.0	30.0	41.0	58.0	18.0	7.5	22.0	14.0	12.0	5.0	—	—
CSA-T10×8-R1/4	10×8	R1/4	29.0	26.0	36.0	58.0	14.0	8.5	19.0	17.0	7.0	6.5	25.0	123.0
CSA-T10×8-R3/8	10×8	R3/8	29.0	26.0	36.0	58.0	14.0	8.5	19.0	17.0	9.0	6.5	27.5	126.0
CSA-L10×8-R1/2	10×8	R1/2	30.5	30.0	41.0	61.0	18.0	8.5	22.0	17.0	12.0	6.5	28.0	168.0
CSA-T12×9-R1/4	12×9	R1/4	31.0	26.0	37.0	62.0	14.0	10	19.0	19.0	7.0	7.0	30.5	134.0
CSA-T12×9-R3/8	12×9	R3/8	31.0	26.0	37.0	62.0	14.0	10	19.0	19.0	9.0	7.5	35.5	138.0
CSA-T12×9-R1/2	12×9	R1/2	32.5	30.0	41.0	65.0	18.0	10	22.0	19.0	12.0	7.5	37.0	180.0
CSA-T12×10-R1/4	12×10	R1/4	31.0	26.0	37.0	62.0	14.0	9	19.0	19.0	7.0	7.0	33.0	130.0
CSA-T12×10-R3/8	12×10	R3/8	31.0	26.0	37.0	62.0	14.0	9	19.0	19.0	9.0	8.5	43.0	133.0
CSA-T12×10-R1/2	12×10	R1/2	32.5	30.0	41.0	65.0	18.0	9	22.0	19.0	12.0	8.5	47.0	174.0

*Made to order

●Inch size type

Product number	Applicable tube outer-inner diameters (mm)	T Thread size (R)	L1 (mm)	L2 (mm)	L4 (mm)	L5 (mm)	A (mm)	F Tube insertion length (mm)	H1 Width across flat (mm)	H2 Width across flat (mm)	d1 (mm)	Min. inner diameter (mm)	Effective cross-sectional area (mm ²)	Weight (g)
CSA-T1/4-R1/8	6.35/4.75	R1/8	23.5	18.0	25.0	47.0	9.0	7	14.0	12.0	5.0	3.5	7.5	53.0
CSA-T1/4-R1/4	6.35/4.75	R1/4	23.5	23.0	30.0	47.0	14.0	7	14.0	12.0	7.0	3.5	7.5	57.0
CSA-T1/4-R3/8	6.35/4.75	R3/8	25.5	26.0	35.5	51.0	14.0	6.5	19.0	12.0	9.0	3.5	—	—
CSA-T3/8-R1/4	9.53/6.99	R1/4	29.0	26.0	36.0	58.0	14.0	8.5	19.0	17.0	7.0	5.8	20.5	124.0
CSA-T3/8-R3/8	9.53/6.99	R3/8	29.0	26.0	36.0	58.0	14.0	8.5	19.0	17.0	9.0	5.8	22.0	128.0
CSA-T3/8-R1/2	9.53/6.99	R1/2	31.0	30.0	41.0	62.0	18.0	9	22.0	17.0	12.0	5.8	—	—
CSA-T1/2-R1/4	12.70/9.56	R1/4	31.5	29.0	38.5	63.0	14.0	10.5	19.0	22.0	7.0	7.0	—	—
CSA-T1/2-R3/8	12.70/9.56	R3/8	32.0	29.0	42.0	64.0	14.0	10.5	19.0	22.0	9.0	8.2	41.0	140.0
CSA-T1/2-R1/2	12.70/9.56	R1/2	33.5	30.5	43.0	67.0	18.0	10.5	22.0	22.0	12.0	8.2	43.0	189.0

*Made to order

Tube

Clean tube

Processed tube

PushOne fitting

QuickSeal fitting

Clean fitting/ Chemifit

Bamboo-shoot fitting

Control switch/ Detachable series

Jig/Tool/ Accessory

Technical information

Reference

Service tee



●Millimeter size type

Product number	Applicable tube outer:inner diameters (mm)	T Thread size (R)	L ₁ (mm)	L ₂ (mm)	L ₃ (mm)	L ₆ (mm)	A (mm)	F Tube insertion length (mm)	H ₁ Width across flat (mm)	H ₂ Width across flat (mm)	d ₁ (mm)	Min. inner diameter (mm)	Effective cross-sectional area (mm ²)	Weight (g)
CSA-ST6×4-R1/8	6×4	R1/8	24.0	18.0	31.0	42.0	9.0	7	14.0	12.0	5.0	3.0	6.0	51.0
CSA-ST6×4-R1/4	6×4	R1/4	24.0	23.5	31.0	47.5	14.0	7	14.0	12.0	7.0	3.0	6.0	56.0
CSA-ST8×6-R1/4	8×6	R1/4	25.0	23.5	33.0	48.5	14.0	7.5	14.0	14.0	7.0	5.0	15.5	61.0
CSA-ST10×8-R3/8	10×8	R3/8	29.0	26.0	39.0	55.0	14.0	8.5	19.0	17.0	9.0	6.5	27.5	120.0
CSA-ST12×9-R1/2	12×9	R1/2	33.0	33.0	46.0	66.0	18.0	10	26.0	19.0	12.0	7.5	37.0	222.0
CSA-ST12×10-R1/2	12×10	R1/2	32.5	33.0	45.5	65.5	18.0	10	26.0	19.0	12.0	8.5	47.0	220.0

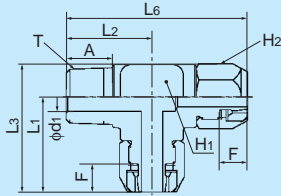

Union connector



●Millimeter size type

Product number	Applicable tube outer:inner diameters (mm)	L (mm)	F Tube insertion length (mm)	H ₁ Width across flat (mm)	H ₂ Width across flat (mm)	Min. inner diameter (mm)	Effective cross-sectional area (mm ²)	Weight (g)
CSA-UC6×4	6×4	32.0	7	12.0	12.0	3.0	7.0	21.0
CSA-UC8×5	8×5	36.0	7.5	14.0	14.0	4.3	13.0	32.0
CSA-UC8×6	8×6	36.0	7.5	14.0	14.0	5.0	18.0	31.0
CSA-UC10×8	10×8	40.0	8.5	17.0	17.0	6.5	31.0	49.0
CSA-UC12×9	12×9	45.0	10	19.0	19.0	7.5	41.0	64.0
CSA-UC12×10	12×10	45.0	10	19.0	19.0	8.5	52.5	61.0

*Made to order

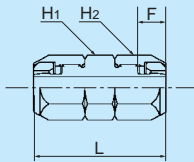

●Inch size type

Product number	Applicable tube outer:inner diameters (mm)	L (mm)	F Tube insertion length (mm)	H ₁ Width across flat (mm)	H ₂ Width across flat (mm)	Min. inner diameter (mm)	Effective cross-sectional area (mm ²)	Weight (g)
CSA-UC1/4	6.35×4.75	32.0	7	12.0	12.0	3.5	9.0	21.0
CSA-UC3/8	9.53×6.99	40.0	8.5	17.0	17.0	5.8	24.0	50.0
CSA-UC1/2	12.70×9.56	48.0	10.5	19.0	22.0	8.2	45.5	74.0

90 degree union elbow



●Millimeter size type

Product number	Applicable tube outer:inner diameters (mm)	L ₁ (mm)	L ₃ (mm)	F Tube insertion length (mm)	H ₁ Width across flat (mm)	H ₂ Width across flat (mm)	Min. inner diameter (mm)	Effective cross-sectional area (mm ²)	Weight (g)
CSA-UL6×4	6×4	23.5	30.5	7	14.0	12.0	3.0	5.0	46.0
CSA-UL8×6	8×6	25.0	33.0	7.5	14.0	14.0	5.0	14.0	50.0
CSA-UL10×8	10×8	29.0	39.0	8.5	19.0	17.0	6.5	24.0	100.0
CSA-UL12×9	12×9	31.0	42.0	10	19.0	19.0	7.5	32.0	112.0
CSA-UL12×10	12×10	31.0	42.0	10	19.0	19.0	8.5	41.5	107.0
CSA-UL19×16	19×16	38.8	54.5	12.3	26.0	27.0	13.0	98.0	265.0

*Made to order

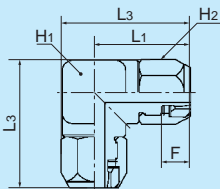

Tube
Clean tube
Processed tube
PushOne fitting
QuickSeal fitting
Clean fitting/ Chemifit
Bamboo-shoot fitting
Control switch/ Detachable series
Jig/Tool/ Accessory
Technical information
Reference

Union tee



●Millimeter size type

Product number	Applicable tube outer:inner diameters (mm)	L ₁ (mm)	L ₃ (mm)	L ₅ (mm)	F Tube insertion length (mm)	H ₁ Width across flat (mm)	H ₂ Width across flat (mm)	Min. inner diameter (mm)	Effective cross-sectional area (mm ²)	Weight (g)
CSA-UT6×4	6×4	23.5	30.5	47.0	7	14.0	12.0	3.0	5.0	63.0
* CSA-UT8×5	8×5	25.0	33.0	50.0	7.5	14.0	14.0	4.3	10.0	77.0
CSA-UT8×6	8×6	25.0	33.0	50.0	7.5	14.0	14.0	5.0	13.5	74.0
CSA-UT10×8	10×8	29.0	39.0	58.0	8.5	19.0	17.0	6.5	24.0	140.0
CSA-UT12×9	12×9	31.0	42.0	62.0	10	19.0	19.0	7.5	32.0	158.0
CSA-UT12×10	12×10	31.0	42.0	62.0	10	19.0	19.0	8.5	41.5	150.0

*Made to order

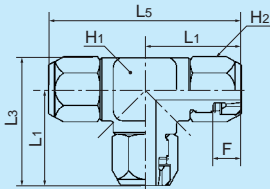

●Inch size type

Product number	Applicable tube outer:inner diameters (mm)	L ₁ (mm)	L ₃ (mm)	L ₅ (mm)	F Tube insertion length (mm)	H ₁ Width across flat (mm)	H ₂ Width across flat (mm)	Min. inner diameter (mm)	Effective cross-sectional area (mm ²)	Weight (g)
CSA-UT1/4	6.35×4.75	23.5	30.0	47.0	7	14.0	12.0	3.5	7.0	62.0
CSA-UT3/8	9.53×6.99	29	39.0	58.0	8.5	19.0	17.0	5.8	19.0	142.0
CSA-UT1/2	12.70×9.56	33.5	46.0	67.0	10.5	22.0	22.0	8.2	37.0	209.0

Panel touch connector



●Millimeter size type

Product number	Applicable tube outer:inner diameters (mm)	L (mm)	F Tube insertion length (mm)	H ₁ Width across flat (mm)	H ₂ Width across flat (mm)	T Recommended panel hole diameter (mm)	t Max. panel thickness (mm)	Washer thickness (mm)	Washer outer diameter (mm)	H×φ Width across flat (mm)	Min. inner diameter (mm)	Effective cross-sectional area (mm ²)	Weight (g)
CSA-UCT6×4	6×4	46.0	7	12.0	21.0	16	6.0	3	28	21.0×23.0	3.0	7.0	—
* CSA-UCT8×5	8×5	48.0	7.5	14.0	22.0	18	6.0	3	30	22.0×24.0	4.3	13.0	—
CSA-UCT8×6	8×6	48.0	7.5	14.0	22.0	18	6.0	3	30	22.0×24.5	5.0	18.0	—
CSA-UCT10×8	10×8	51.0	8.5	17.0	26.0	21	6.0	3	37	26.0×29.0	6.5	31.0	—
CSA-UCT12×9	12×9	55.5	10	19.0	27.0	23	5.5	3	37	27.0×30.0	7.5	41.0	—
CSA-UCT12×10	12×10	54.5	10	19.0	27.0	23	5.5	3	37	27.0×30.0	8.5	52.5	—

*Made to order

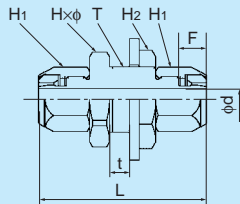

Assembly nut



●Millimeter size type

Product number	Applicable tube outer diameter (mm)	L (mm)	H ₂ Width across flat (mm)	Weight (g)
CSAN4	4	11.0	10.0	4.0
CSAN6	6	12.5	12.0	6.0
CSAN8	8	14.0	14.0	8.5
CSAN10	10	15.5	17.0	14.0
CSAN12	12	17.5	19.0	18.5
* CSAN19	19	22.5	27.0	37.5

*Made to order

●Inch size type

Product number	Applicable tube outer diameter (inch)	L (mm)	H ₂ Width across flat (mm)	Weight (g)
CSAN1/4	1/4	12.5	12.0	6.0
CSAN3/8	3/8	15.5	17.0	14.5
CSAN1/2	1/2	19.0	22.0	29.0

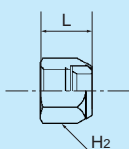

Bushing

●Millimeter size type



Product number	T ₁ Thread size (Rc)	T ₂ Thread size (R)	L (mm)	A ₁ (mm)	A ₂ (mm)	H×φ Width across flat (mm)	d ₁ (mm)	Weight (g)
3A0-4-6-CS	Rc1/4	R3/8	29.0	14.0	13.0	17.0×18.5	9.0	—
3A0-6-8-CS	Rc3/8	R1/2	34.5	18.0	13.5	22.0×24.5	11.0	—
3A0-8-12-CS	Rc1/2	R3/4	40.0	20.0	17.5	30.0×33.0	11.0	—

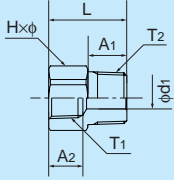

Socket

●Millimeter size type



Product number	T Thread size (Rc)	L (mm)	A (mm)	H×φ Width across flat (mm)	d ₁ (mm)	Weight (g)
330-4-4-CS	Rc1/4	30.0	13.0	17.0×18.5	9.0	—
330-6-6-CS	Rc3/8	33.0	13.5	19.0×21.0	13.0	—
330-8-8-CS	Rc1/2	39.5	17.5	24.0×26.5	17.0	—

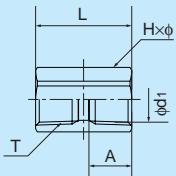

Tube

Clean tube

Processed tube

PushOne fitting

QuickSeal fitting

Clean fitting/ Chemifit

Bamboo-shoot fitting

Control switch/ Detachable series

Jig/Tool/ Accessory

Technical information

Reference

Reference

Technical information

Jig/Tool/
Accessory

Control switch/
Detachable
series

Bambo-
shoot fitting

Clean fitting/
Chemifit

QuickSeal
fitting

PushOne
fitting

Processed
tube

Clean tube

Tube

Chemifit® CS Series

Threaded fitting for clean air, pure water and chemical liquids

Features

- **SUS316 threaded fitting**
Consisting of three parts: fitting body, nut and sleeve.
- **Uniform workability for connecting tube.**
Tube connection is completed when the assembly nut reaches the fitting body. There is no need for torque control or special tools.
- **No rotation of tube when the tube is attached**
A sleeve inside the assembly nut can rotate. Hence the inserted tube does not rotate together.
- **No-oil processed**
Assembled after cleaning each part in a clean room.
- **High sealing performance**
Nitta's original sealing mechanism achieves high durability against degradation of sealing performance due to hot-cold cycling.
- **No need for additional tightening of the nut**
The structure with less stress relaxation ensures high sealing performance for a long period of time and the nut does not need to be tightened at maintenance.
- **Highly smooth inner surface and R sphere surface processing on the elbow crossing**
The surface roughness is below Ra3.2. The corner of the elbow is sphere surface processed, which reduces liquid and detergent remains.
- **Silver plated thread inside the nut**
It prevents seizing of the fitting body and the assembly nut when a tube is tightly inserted.



Operating fluid, working temperature range

Operating fluid	Working temperature range
Air (clean air)	-65°C~+260°C
Water (pure water)	0°C~+100°C

☞ Contact us for various chemical liquids.

☞ See "Combination List of Tube and Fitting" on page 8.

Pressure condition

Maximum working pressure: 5.0MPa
Negative pressure performance: -101.294kPa

Handling instructions

⚠ **Caution** When the working conditions of tubes and fittings differ, use them under the lower specified conditions.

⚠ **Caution** Sleeves must be attached in the correct direction. Attaching a sleeve in the wrong direction allows fluid leakage so be sure to check the direction when fitting.

⚠ **Caution** When water is used as the operating fluid, do not allow it to freeze.

⚠ **Caution** Do not bend the pipe sharply near the tube insertion port of the fitting. Keep the tube straight for twice as long as the tube diameter from the insertion port.

☞ See page34 for the common handling instructions for tube fittings.

Distinction of millimeter/inch sizes

Sleeve

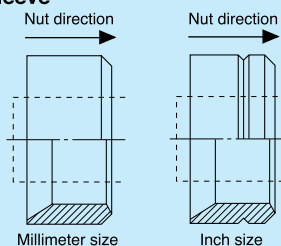

Reference

Instruction manual·····P.188
Chemical resistance specification table··P.207
Effective cross-sectional area······P.176
Negative-pressure performance list··P.177

Cross-sectional structure diagram

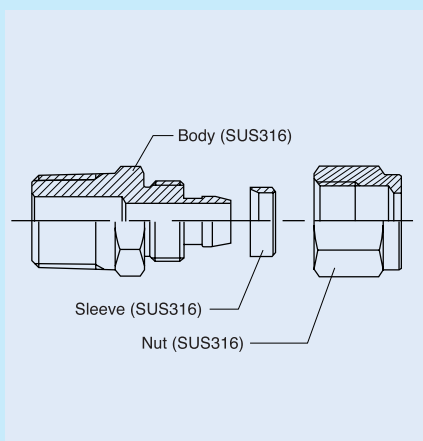

Sealing mechanism

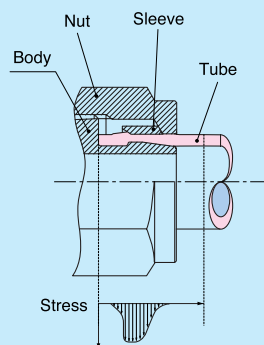





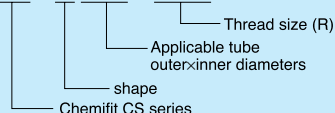

Nitta's original sealing mechanism achieves high durability against degradation of sealing performance due to hot-cold cycling. The mechanism does not cause stress relaxation, ensuring sealing performance for a long period of time. Also, the nut does not need to be tightened at maintenance.

Product number example

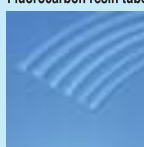
CS - C 6×4 - R1/4

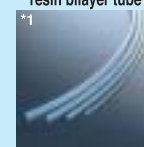

Applicable tube

Polyolefine resin tube	Fluorocarbon resin tube	Polyurethane tube	Flexible fluorocarbon resin bilayer tube	Polybutene tube	Antistatic tube	Polyurethane processed tube
						
PL····P.26 PN····P.27	TA····P.28	U2····P.12 U1····P.13 U5····P.14	TES····P.18	PB····P.25	UE····P.23	UC····P.30 USC····P.30 UMC····P.30 UML····P.31

(*1) Combinatory use of U2, U1, U5, TES, PB, UE or polyurethane processed tube and Chemifit CS series mixes general and clean type performances. When using them in a clean environment, pay attention to the clean level that could be lowered.

Chemifit® CS Series

Shape list



Tube

Clean tube

Processed tube

PushOne fitting

QuickSeal fitting

Clean fitting/
Chemifit

Bamboo-shoot fitting

Control switch/
Detachable series

Jig/Tool/
Accessory

Technical information

Reference

No-oil processing, Clean wrapping and packaging

- Ultrasonic cleaning with no oil or fat used for assembling in a clean room

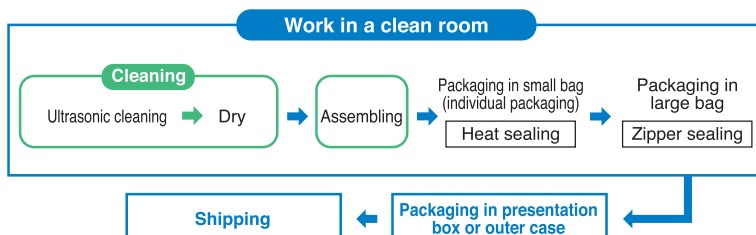

- High-barrier sheet packaging available

What is high-barrier sheet packaging?

In order to maintain the cleanliness of our products, no space for oxygen, water, or corrosive gas is allowed inside the package and a packaging bag with a high gas barrier is needed for protecting the content from these gases. To meet this requirement, Nitta provides high-barrier bags with a high gas barrier performance also for nitrogen sealing or atmospheric sealing.



- The packaging bags that Nitta uses have the highest gas barrier performance among clear bags.
- The bags do not contain halogen, etc, for safe burning.

Connector

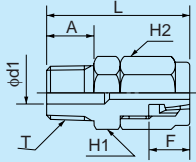

●Millimeter size type

Product number	Applicable tube outer/inner diameters (mm)	T Thread size (R)	L (mm)	A (mm)	F Tube insertion length (mm)	H ₁ Width across flat (mm)	H ₂ Width across flat (mm)	d ₁ (mm)	Min. inner diameter (mm)	Effective cross-sectional area (mm ²)	Weight (g)
CS-C4×2-R1/8	4×2	R1/8	24.0	9.0	5.5	10.0	10.0	5.0	1.3	1.5	11.0
CS-C4×2-R1/4	4×2	R1/4	29.0	14.0	5.5	14.0	10.0	7.0	1.3	1.5	19.0
CS-C6×4-R1/8	6×4	R1/8	26.5	9.0	7	12.0	12.0	5.0	3.0	7.0	17.0
CS-C6×4-R1/4	6×4	R1/4	31.5	14.0	7	14.0	12.0	7.0	3.0	7.0	24.0
CS-C6×4-R3/8	6×4	R3/8	31.5	14.0	7	17.0	12.0	9.0	3.0	7.0	33.0
CS-C8×6-R1/8	8×6	R1/8	28.0	9.0	7.5	14.0	14.0	5.0	5.0	18.0	24.0
CS-C8×6-R1/4	8×6	R1/4	33.0	14.0	7.5	14.0	14.0	7.0	5.0	18.0	29.0
CS-C8×6-R3/8	8×6	R3/8	33.0	14.0	7.5	17.0	14.0	9.0	5.0	18.0	38.0
CS-C8×6-R1/2	8×6	R1/2	37.0	18.0	7.5	22.0	14.0	12.0	5.0	18.0	60.0
CS-C10×8-R1/4	10×8	R1/4	34.5	14.0	8.5	17.0	17.0	7.0	6.5	31.0	40.0
CS-C10×8-R3/8	10×8	R3/8	34.5	14.0	8.5	17.0	17.0	9.0	6.5	31.0	46.0
CS-C10×8-R1/2	10×8	R1/2	38.5	18.0	8.5	22.0	17.0	12.0	6.5	31.0	65.0
CS-C12×9-R1/4	12×9	R1/4	36.5	14.0	10	17.0	19.0	7.5	7.5	41.0	46.0
CS-C12×9-R3/8	12×9	R3/8	36.5	14.0	10	17.0	19.0	9.0	7.5	41.0	53.0
CS-C12×9-R1/2	12×9	R1/2	40.5	18.0	10	22.0	19.0	12.0	7.5	41.0	72.0
CS-C12×10-R1/4	12×10	R1/4	36.5	14.0	10	17.0	19.0	7.5	7.5	42.5	45.0
CS-C12×10-R3/8	12×10	R3/8	36.5	14.0	10	17.0	19.0	9.0	8.5	52.5	51.0
CS-C12×10-R1/2	12×10	R1/2	40.5	18.0	10	22.0	19.0	12.0	8.5	52.5	71.0
CS-C19×16-R1/2	19×16	R1/2	45.5	18.0	12.5	27.0	27.0	12.0	12.0	106.0	115.0

●Inch size type

Product number	Applicable tube outer/inner diameters (mm)	T Thread size (R)	L (mm)	A (mm)	F Tube insertion length (mm)	H ₁ Width across flat (mm)	H ₂ Width across flat (mm)	d ₁ (mm)	Min. inner diameter (mm)	Effective cross-sectional area (mm ²)	Weight (g)
CS-C1/4-R1/8	6.35×4.75	R1/8	26.5	9.0	7	12.0	12.0	5.0	3.5	9.0	17.0
CS-C1/4-R1/4	6.35×4.75	R1/4	31.5	14.0	7	14.0	12.0	7.0	3.5	9.0	24.0
CS-C1/4-R3/8	6.35×4.75	R3/8	31.0	14.0	6.5	17.0	12.0	9.0	3.5	9.0	—
CS-C3/8-R1/4	9.53×6.99	R1/4	34.5	14.0	8.5	17.0	17.0	7.0	5.8	25.5	41.0
CS-C3/8-R3/8	9.53×6.99	R3/8	34.5	14.0	9	17.0	17.0	9.0	5.8	25.5	46.0
CS-C3/8-R1/2	9.53×6.99	R1/2	39.0	18.0	9	22.0	17.0	12.0	5.8	22.0	—
CS-C1/2-R1/4	12.70×9.56	R1/4	38.0	14.0	10.5	19.0	22.0	7.0	7.0	—	—
CS-C1/2-R3/8	12.70×9.56	R3/8	38.0	14.0	10.5	19.0	22.0	9.0	8.2	51.0	63.0
CS-C1/2-R1/2	12.70×9.56	R1/2	42.0	18.0	10.5	22.0	22.0	12.0	8.2	51.0	80.0

Internal connector

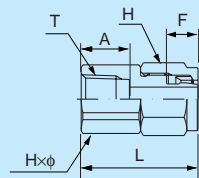

●Millimeter size type

Product number	Applicable tube outer/inner diameters (mm)	T Thread size (R)	L (mm)	A (mm)	F Tube insertion length (mm)	H Width across flat (mm)	H×φ Width across flat (mm)	Min. inner diameter (mm)	Effective cross-sectional area (mm ²)	Weight (g)
CS-FC6×4-R1/8	6×4	R1/8	24.5	8.7	7	12.0	14.0×15.4	3.0	6.0	20.0
CS-FC8×6-R1/4	8×6	R1/4	30.0	13.0	7.5	14.0	17.0×18.5	5.0	18.0	33.0
CS-FC10×8-R1/4	10×8	R1/4	31.5	13.0	8.5	17.0	17.0×18.5	6.5	31.0	40.0

Tube
Clean tube
Processed tube
PushOne fitting
QuickSeal fitting
Clean fitting/ Chemifit
Bamboo-shoot fitting
Control switch/ Detachable series
Jig/Tool/ Accessory
Technical information
Reference

90 degree elbow

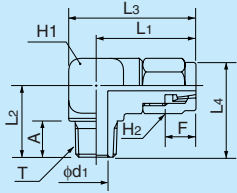

●Millimeter size type

Product number	Applicable tube outer-inner diameters (mm)	T Thread size (R)	L1 (mm)	L2 (mm)	L3 (mm)	L4 (mm)	A (mm)	F Tube insertion length (mm)	H1 Width across flat (mm)	H2 Width across flat (mm)	d1 (mm)	Min. inner diameter (mm)	Effective cross-sectional area (mm ²)	Weight (g)
CS-L6×4-R1/8	6×4	R1/8	23.5	18.0	30.5	25.0	9.0	7	14.0	12.0	5.0	3.0	6.0	40.0
CS-L6×4-R1/4	6×4	R1/4	23.5	23.0	30.5	30.0	14.0	7	14.0	12.0	7.0	3.0	6.0	44.0
CS-L6×4-R3/8	6×4	R3/8	26.0	26.0	35.5	35.5	14.0	7	19.0	12.0	9.0	3.0	6.0	87.0
CS-L8×6-R1/8	8×6	R1/8	25.0	19.0	32.0	27.0	9.0	7.5	14.0	14.0	5.0	5.0	14.0	45.0
CS-L8×6-R1/4	8×6	R1/4	25.0	23.0	32.0	32.0	14.0	7.5	14.0	14.0	7.0	5.0	15.5	48.0
CS-L8×6-R3/8	8×6	R3/8	27.5	26.0	37.0	35.5	14.0	7.5	19.0	14.0	9.0	5.0	16.0	91.0
CS-L10×8-R1/4	10×8	R1/4	29.0	26.0	38.5	36.0	14.0	8.5	19.0	17.0	7.0	6.5	25.0	94.0
CS-L10×8-R3/8	10×8	R3/8	29.0	26.0	38.5	36.0	14.0	8.5	19.0	17.0	9.0	6.5	27.5	98.0
CS-L10×8-R1/2	10×8	R1/2	30.5	30.0	41.5	40.0	18.0	8.5	22.0	17.0	12.0	6.5	28.0	137.0
CS-L12×9-R1/4	12×9	R1/4	31.0	26.0	40.5	37.0	14.0	10	19.0	19.0	7.0	7.0	30.5	100.0
CS-L12×9-R3/8	12×9	R3/8	31.0	26.0	40.5	37.0	14.0	10	19.0	19.0	9.0	7.5	35.5	104.0
CS-L12×9-R1/2	12×9	R1/2	32.5	30.0	43.5	41.0	18.0	10	22.0	19.0	12.0	7.5	37.0	143.0
CS-L12×10-R1/4	12×10	R1/4	31.0	26.0	40.5	37.0	14.0	10	19.0	19.0	7.0	7.0	33.0	98.0
CS-L12×10-R3/8	12×10	R3/8	31.0	26.0	40.5	37.0	14.0	10	19.0	19.0	9.0	8.5	43.0	101.0
CS-L12×10-R1/2	12×10	R1/2	32.5	30.0	43.5	41.0	18.0	10	22.0	19.0	12.0	8.5	47.0	140.0
CS-L19×16-R1/2	19×16	R1/2	37.5	33.5	50.5	49.0	18.0	12.5	26.0	27.0	12.0	12.0	—	—

●Inch size type

Product number	Applicable tube outer-inner diameters (mm)	T Thread size (R)	L1 (mm)	L2 (mm)	L3 (mm)	L4 (mm)	A (mm)	F Tube insertion length (mm)	H1 Width across flat (mm)	H2 Width across flat (mm)	d1 (mm)	Min. inner diameter (mm)	Effective cross-sectional area (mm ²)	Weight (g)
CS-L1/4-R1/8	6.35×4.75	R1/8	23.5	18.0	30.5	25.0	9.0	7	14.0	12.0	5.0	3.5	7.5	40.0
CS-L1/4-R1/4	6.35×4.75	R1/4	23.5	23.0	30.5	30.0	14.0	7	14.0	12.0	7.0	3.5	7.5	44.0
CS-L1/4-R3/8	6.35×4.75	R3/8	25.5	26.0	35.0	35.5	14.0	6.5	19.0	12.0	9.0	3.5	—	—
CS-L3/8-R1/4	9.53×6.99	R1/4	29.0	26.0	38.5	36.0	14.0	8.5	19.0	17.0	7.0	5.8	20.5	95.0
CS-L3/8-R3/8	9.53×6.99	R3/8	29.0	26.0	38.5	36.0	14.0	8.5	19.0	17.0	9.0	5.8	22.0	99.0
CS-L3/8-R1/2	9.53×6.99	R1/2	31.0	30.0	42.0	41.0	18.0	9	22.0	17.0	12.0	5.8	—	—
CS-L1/2-R1/4	12.70×9.56	R1/4	31.5	29.0	41.0	38.5	14.0	10.5	19.0	22.0	7.0	7.0	—	—
CS-L1/2-R3/8	12.70×9.56	R3/8	32.0	29.0	41.5	42.0	14.0	10.5	19.0	22.0	9.0	8.2	41.0	110.0
CS-L1/2-R1/2	12.70×9.56	R1/2	33.5	30.5	44.5	43.0	18.0	10.5	22.0	22.0	12.0	8.2	43.0	148.0

Tee

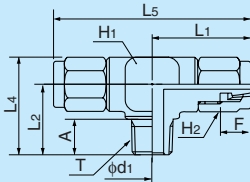

●Millimeter size type

Product number	Applicable tube outer-inner diameters (mm)	T Thread size (R)	L1 (mm)	L2 (mm)	L4 (mm)	L5 (mm)	A (mm)	F Tube insertion length (mm)	H1 Width across flat (mm)	H2 Width across flat (mm)	d1 (mm)	Min. inner diameter (mm)	Effective cross-sectional area (mm ²)	Weight (g)
CS-T6×4-R1/8	6×4	R1/8	23.5	18.0	25.0	47.0	9.0	7	14.0	12.0	5.0	3.0	6.0	54.0
CS-T6×4-R1/4	6×4	R1/4	23.5	23.0	30.0	47.0	14.0	7	14.0	12.0	7.0	3.0	6.0	58.0
CS-T6×4-R3/8	6×4	R3/8	26.0	26.0	35.5	52.0	14.0	7	19.0	12.0	9.0	3.0	6.0	105.0
CS-T8×6-R1/8	8×6	R1/8	25.0	19.0	27.0	50.0	9.0	7.5	14.0	14.0	5.0	5.0	14.0	62.0
CS-T8×6-R1/4	8×6	R1/4	25.0	23.0	32.0	50.0	14.0	7.5	14.0	14.0	7.0	5.0	15.5	65.0
CS-T8×6-R3/8	8×6	R3/8	27.5	26.0	35.5	55.0	14.0	7.5	19.0	14.0	9.0	5.0	16.0	112.0
CS-T10×8-R1/4	10×8	R1/4	29.0	26.0	36.0	58.0	14.0	8.5	19.0	17.0	7.0	6.5	25.0	123.0
CS-T10×8-R3/8	10×8	R3/8	29.0	26.0	36.0	58.0	14.0	8.5	19.0	17.0	9.0	6.5	27.5	126.0
CS-T10×8-R1/2	10×8	R1/2	30.5	30.0	41.0	61.0	18.0	8.5	22.0	17.0	12.0	6.5	28.0	168.0
CS-T12×9-R1/4	12×9	R1/4	31.0	26.0	37.0	62.0	14.0	10	19.0	19.0	7.0	7.0	30.5	134.0
CS-T12×9-R3/8	12×9	R3/8	31.0	26.0	37.0	62.0	14.0	10	19.0	19.0	9.0	7.5	35.5	138.0
CS-T12×9-R1/2	12×9	R1/2	32.5	30.0	41.0	65.0	18.0	10	22.0	19.0	12.0	7.5	37.0	180.0
CS-T12×10-R1/4	12×10	R1/4	31.0	26.0	37.0	62.0	14.0	9.0	19.0	19.0	7.0	7.0	33.0	130.0
CS-T12×10-R3/8	12×10	R3/8	31.0	26.0	37.0	62.0	14.0	9.0	19.0	19.0	9.0	8.5	43.0	133.0
CS-T12×10-R1/2	12×10	R1/2	32.5	30.0	41.0	65.0	18.0	9.0	22.0	19.0	12.0	8.5	47.0	174.0

●Inch size type

Product number	Applicable tube outer-inner diameters (mm)	T Thread size (R)	L1 (mm)	L2 (mm)	L4 (mm)	L5 (mm)	A (mm)	F Tube insertion length (mm)	H1 Width across flat (mm)	H2 Width across flat (mm)	d1 (mm)	Min. inner diameter (mm)	Effective cross-sectional area (mm ²)	Weight (g)
CS-T1/4-R1/8	6.35×4.75	R1/8	23.5	18.0	25.0	47.0	9.0	7	14.0	12.0	5.0	3.5	7.5	53.0
CS-T1/4-R1/4	6.35×4.75	R1/4	23.5	23.0	30.0	47.0	14.0	7	14.0	12.0	7.0	3.5	7.5	57.0
CS-T1/4-R3/8	6.35×4.75	R3/8	25.5	26.0	35.5	51.0	14.0	6.5	19.0	12.0	9.0	3.5	—	—
CS-T3/8-R1/4	9.53×6.99	R1/4	29.0	26.0	36.0	58.0	14.0	8.5	19.0	17.0	7.0	5.8	20.5	124.0
CS-T3/8-R3/8	9.53×6.99	R3/8	29.0	26.0	36.0	58.0	14.0	8.5	19.0	17.0	9.0	5.8	22.0	128.0
CS-T3/8-R1/2	9.53×6.99	R1/2	31.0	30.0	41.0	62.0	18.0	9	22.0	17.0	12.0	5.8	—	—
CS-T1/2-R1/4	12.70×9.56	R1/4	31.5	29.0	38.5	63.0	14.0	10.5	19.0	22.0	7.0	7.0	—	—
CS-T1/2-R3/8	12.70×9.56	R3/8	32.0	29.0	42.0	64.0	14.0	10.5	19.0	22.0	9.0	8.2	41.0	140.0
CS-T1/2-R1/2	12.70×9.56	R1/2	33.5	30.5	43.0	67.0	18.0	10.5	22.0	22.0	12.0	8.2	43.0	189.0

Tube

Clean tube

Processed tube

PushOne fitting

QuickSeal fitting

Clean fitting/ Chemifit

Bamboo-shoot fitting

Control switch/ Detachable series

Jig/Tool/ Accessory

Technical information

Reference

Service tee

●Millimeter size type



Product number	Applicable tube outer:inner diameters (mm)	T Thread size (R)	L1 (mm)	L2 (mm)	L3 (mm)	L5 (mm)	A (mm)	F Tube insertion length (mm)	H1 Width across flat (mm)	H2 Width across flat (mm)	d1 (mm)	Min. inner diameter (mm)	Effective cross-sectional area (mm ²)	Weight (g)
CS-ST6×4-R1/8	6×4	R1/8	24.0	18.0	31.0	42.0	9.0	7	14.0	12.0	5.0	3.0	6.0	51.0
CS-ST6×4-R1/4	6×4	R1/4	24.0	23.5	31.0	47.5	14.0	7	14.0	12.0	7.0	3.0	6.0	56.0
CS-ST8×6-R1/4	8×6	R1/4	25.0	23.5	33.0	48.5	14.0	7.5	14.0	14.0	7.0	5.0	15.5	61.0
CS-ST10×8-R3/8	10×8	R3/8	29.0	26.0	39.0	55.0	14.0	8.5	19.0	17.0	9.0	6.5	27.5	120.0
CS-ST12×9-R1/2	12×9	R1/2	33.0	33.0	46.0	66.0	18.0	10	26.0	19.0	12.0	7.5	37.0	222.0
CS-ST12×10-R1/2	12×10	R1/2	32.5	33.0	45.5	65.5	18.0	10	26.0	19.0	12.0	8.5	47.0	220.0

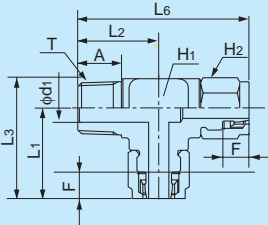

Union connector

●Millimeter size type



Product number	Applicable tube outer:inner diameters (mm)	L (mm)	F Tube insertion length (mm)	H1 Width across flat (mm)	H2 Width across flat (mm)	Min. inner diameter (mm)	Effective cross-sectional area (mm ²)	Weight (g)
CS-UC6×4	6×4	32.0	7	12.0	12.0	3.0	7.0	21.0
CS-UC8×6	8×6	36.0	7.5	14.0	14.0	5.0	18.0	31.0
CS-UC10×8	10×8	40.0	8.5	17.0	17.0	6.5	31.0	49.0
CS-UC12×9	12×9	45.0	10	19.0	19.0	7.5	41.0	64.0
CS-UC12×10	12×10	45.0	10	19.0	19.0	8.5	52.5	61.0

●Inch size type

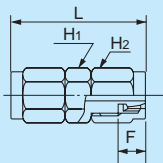

Product number	Applicable tube outer:inner diameters (mm)	L (mm)	F Tube insertion length (mm)	H1 Width across flat (mm)	H2 Width across flat (mm)	Min. inner diameter (mm)	Effective cross-sectional area (mm ²)	Weight (g)
CS-UC1/4	6.35×4.75	32.0	7	12.0	12.0	3.5	9.0	21.0
CS-UC3/8	9.53×6.99	40.0	8.5	17.0	17.0	5.8	24.0	50.0
CS-UC1/2	12.70×9.56	48.0	10.5	19.0	22.0	8.2	45.5	74.0

90 degree union elbow

●Millimeter size type



Product number	Applicable tube outer:inner diameters (mm)	L1 (mm)	L3 (mm)	F Tube insertion length (mm)	H1 Width across flat (mm)	H2 Width across flat (mm)	Min. inner diameter (mm)	Effective cross-sectional area (mm ²)	Weight (g)
CS-UL6×4	6×4	23.5	30.5	7	14.0	12.0	3.0	5.0	46.0
CS-UL8×6	8×6	25.0	33.0	7.5	14.0	14.0	5.0	14.0	50.0
CS-UL10×8	10×8	29.0	39.0	8.5	19.0	17.0	6.5	24.0	100.0
CS-UL12×9	12×9	31.0	42.0	10	19.0	19.0	7.5	32.0	112.0
CS-UL12×10	12×10	31.0	42.0	10	19.0	19.0	8.5	41.5	107.0
CS-UL19×16	19×16	38.8	54.5	12.3	26.0	27.0	13.0	98.0	265.0

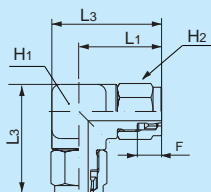

Tube
Clean tube
Processed tube
PushOne fitting
QuickSeal fitting
Clean fitting/ Chemifit
Bamboo-shoot fitting
Control switch/ Detachable series
Jig/Tool/ Accessory
Technical information
Reference

Union tee



●Millimeter size type

Product number	Applicable tube outer/inner diameters (mm)	L ₁ (mm)	L ₃ (mm)	L ₅ (mm)	F Tube insertion length (mm)	H ₁ Width across flat (mm)	H ₂ Width across flat (mm)	Min. inner diameter (mm)	Effective cross-sectional area (mm ²)	Weight (g)
CS-UT6×4	6×4	23.5	30.5	47.0	7	14.0	12.0	3.0	5.0	63.0
CS-UT8×6	8×6	25.0	33.0	50.0	7	14.0	14.0	5.0	13.5	74.0
CS-UT10×8	10×8	29.0	39.0	58.0	8.5	19.0	17.0	6.5	24.0	140.0
CS-UT12×9	12×9	31.0	42.0	62.0	10	19.0	19.0	7.5	32.0	158.0
CS-UT12×10	12×10	31.0	42.0	62.0	10	19.0	19.0	8.5	41.5	150.0

●Inch size type

Product number	Applicable tube outer/inner diameters (mm)	L ₁ (mm)	L ₃ (mm)	L ₅ (mm)	F Tube insertion length (mm)	H ₁ Width across flat (mm)	H ₂ Width across flat (mm)	Min. inner diameter (mm)	Effective cross-sectional area (mm ²)	Weight (g)
CS-UT1/4	6.35×4.75	23.5	30.0	47.0	7	14.0	12.0	3.5	7.0	62.0
CS-UT3/8	9.53×6.99	29.0	39.0	58.0	8.5	19.0	17.0	5.8	19.0	142.0
CS-UT1/2	12.70×9.56	33.5	46.0	67.0	10.5	22.0	22.0	8.2	37.0	209.0

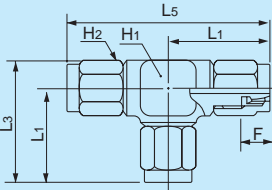

Panel touch connector

●Millimeter size type

Product number	Applicable tube outer/inner diameters (mm)	L (mm)	F Tube insertion length (mm)	H ₁ Width across flat (mm)	H ₂ Width across flat (mm)	T Recommended panel hole diameter (mm)	t Max. panel thickness (mm)	Washer thickness (mm)	Washer outer diameter (mm)	H×φ Width across flat (mm)	Min. inner diameter (mm)	Effective cross-sectional area (mm ²)	Weight (g)
CS-UCT6×4	6×4	46	7	12.0	21.0	16	6.0	3	28	21.0×23.0	3.0	7.0	—
CS-UCT8×6	8×6	48	7.5	14.0	22.0	18	6.0	3	30	22.0×24.5	5.0	18.0	—
CS-UCT10×8	10×8	51	8.5	17.0	26.0	21	6.0	3	37	26.0×29.0	6.5	31.0	—
CS-UCT12×9	12×9	55.5	10	19.0	27.0	23	5.5	3	37	27.0×30.0	7.5	41.0	—
CS-UCT12×10	12×10	54.5	10	19.0	27.0	23	5.5	3	37	27.0×30.0	8.5	52.5	—

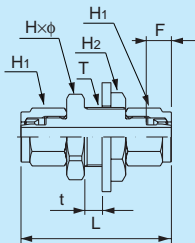

Nut

●Millimeter size type

Product number	Applicable tube outer diameter (mm)	L (mm)	H ₂ Width across flat (mm)	Weight (g)
CSN4	4	11.0	10.0	4.0
CSN6	6	12.5	12.0	6.0
CSN8	8	14.0	14.0	8.5
CSN10	10	15.5	17.0	14.0
CSN12	12	17.5	19.0	18.5
CSN19	19	22.5	27.0	37.5

●Inch size type

Product number	Applicable tube outer diameter (inch)	L (mm)	H ₂ Width across flat (mm)	Weight (g)
CSN6 *1	1/4	12.5	12.0	6.0
CSN10 *2	3/8	15.5	17.0	14.5
CSN1/2	1/2	19.0	22.0	29.0



*1 The size 1/4 is shared with CSN6.

*2 The size 3/8 is shared with CSN10.

Sleeve

●Millimeter size type



Product number	Applicable tube outer diameter (mm)
CSS4	4
CSS6	6
CSS8	8
CSS10	10
CSS12	12
CSS19	19

⚠ **Caution** The CS series sleeves must be fitted in the correct direction. Be sure to check the direction when attaching it.

Millimeter size type

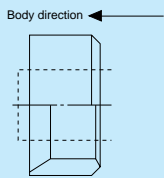

●Inch size type

Product number	Applicable tube outer diameter (inch)
CSS1/4	1/4
CSS3/8	3/8
CSS1/2	1/2

⚠ **Caution** The CS series sleeves must be fitted in the correct direction. Be sure to check the direction when attaching it.

Inch size type

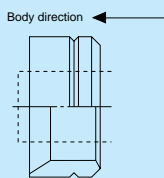

Bushing

●Millimeter size type



Product number	T1 Thread size (Rc)	T2 Thread size (R)	L (mm)	A1 (mm)	A2 (mm)	H×φ Width across flat (mm)	d1 (mm)	Weight (g)
3A0-4-6-CS	Rc1/4	R3/8	29.0	14.0	13.0	17.0×18.5	9.0	—
3A0-6-8-CS	Rc3/8	R1/2	34.5	18.0	13.5	22.0×24.5	11.0	—
3A0-8-12-CS	Rc1/2	R3/4	40.0	20.0	17.5	30.0×33.0	11.0	—

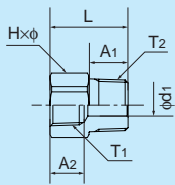

Socket

●Millimeter size type



Product number	T Thread size (Rc)	L (mm)	A (mm)	H×φ Width across flat (mm)	d1 (mm)	Weight (g)
330-4-4-CS	Rc1/4	30.0	13.0	17.0×18.5	9.0	—
330-6-6-CS	Rc3/8	33.0	13.5	19.0×21.0	13.0	—
330-8-8-CS	Rc1/2	39.5	17.5	24.0×26.5	17.0	—

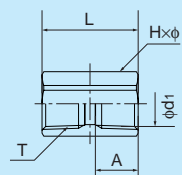

Tube

Clean tube

Processed tube

PushOne fitting

QuickSeal fitting

Clean fitting/ Chemifit

Bamboo-shoot fitting

Control switch/ Detachable series

Jig/Tool/ Accessory

Technical information

Reference

Reference

Technical information

Jig/Tool/
Accessory

Control switch/
Detachable series

Bambooo-
shoot fitting

Clean fitting/
Chemifit

QuickSeal
fitting

PushOne
fitting

Processed
tube

Clean tube

Tube

Chemifit® CP Series

Threaded fitting for clean air, pure water and chemical liquids

Features

- Threaded fitting made of polypropylene resin
Light weight.
- No-oil processed
Each part is cleaned in a clean room.
- Highly smooth inner surface
Smooth inner surface due to ejection forming.
- High dust-free, uncontaminated performance
Made of special polypropylene resin.
- Compliant with the MHLW Ministerial Notification No.201(2006),
MHW Ministerial Notification No.370(1959), Japan

Cross-sectional structure diagram

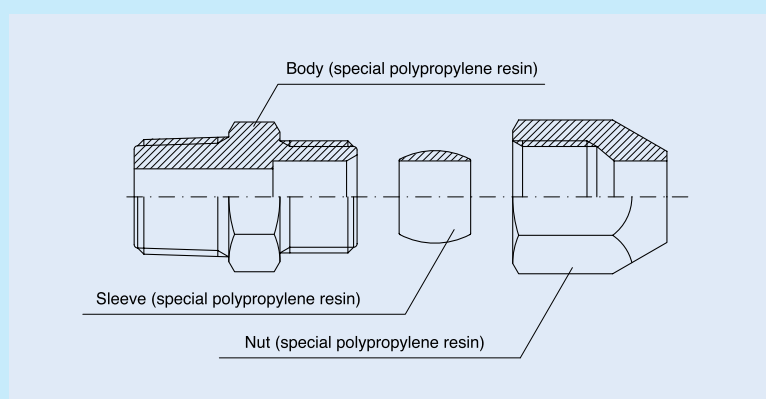

Product number example

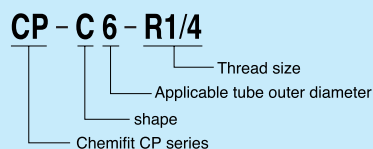

Distinction of millimeter/inch sizes

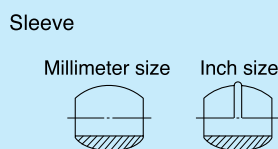

The millimeter and inch size types of the Chemifit CP series are distinguished by the outer shape of the sleeve.

Applicable tube

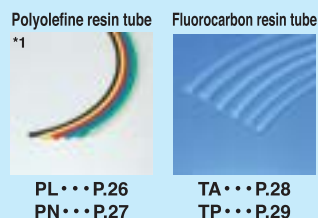

(*1) Use an insertion part (sold separately) to attach a flexible tube.



Operating fluid, working temperature range

Operating fluid	Working temperature range
Air (clean air)	-20°C~+80°C
Water (pure water)	0°C~+80°C

☞ Contact us for various chemical liquids.

☞ See "Combination List of Tube and Fitting" on page 8.

Pressure condition

Maximum working pressure: 0.4MPa(at20°C)
Negative pressure performance: -99.975kPa

Handling instructions

⚠ **Caution** When the working conditions of tubes and fittings differ, use them under the lower specified conditions.

⚠ **Caution** Use an insertion part (sold separately) to attach a flexible tube.

⚠ **Caution** Stress relaxation occurs more readily with resin thread than with metal thread. The relaxation is prominent at a high temperature. Tighten the thread periodically.

⚠ **Caution** For use at a high temperature within the working temperature range, tighten the nut periodically. If the nut cannot be tightened further, cut the tube end and insert the tube again with a new sleeve.

⚠ **Caution** When water is used as the operating fluid, do not allow it to freeze.

⚠ **Caution** Do not bend the pipe sharply near the tube insertion port (sleeve end) of the fitting. Keep the tube straight for twice as long as the tube diameter from the insertion port.

☞ See page34 for the common handling instructions for tube fittings.

Reference

Instruction manual.....P.190
Chemical resistance
specification table.....P.207
Effective cross-sectional
areaP.176
Negative-pressure
performance list.....P.177

Chemifit® CP Series

Shape list



Relation between the working temperature and the maximum working pressure

The maximum working pressure varies with the working temperature (environmental temperature). For use at an abnormal temperature, always check the maximum working pressure change in the graph below and keep the pressure within the indicated range.

⚠ Caution Using tubes at a pressure outside the range may cause accidents or damage, for which Nitta is not liable.

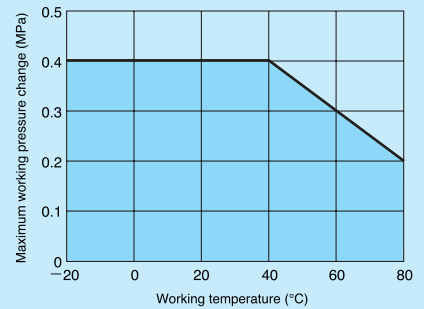

No-oil processing, Clean wrapping and packaging

● Ultrasonic cleaning with no oil or fat used for assembling in a clean room

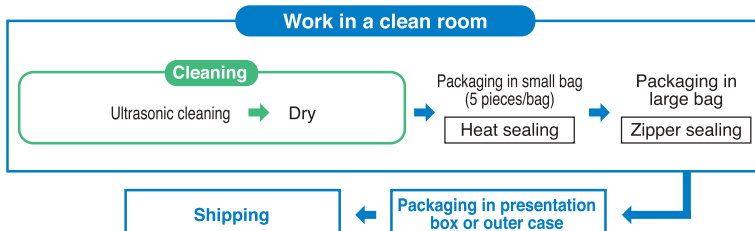

● High-barrier sheet packaging available

What is high-barrier sheet packaging?

In order to maintain the cleanliness of our products, no space for oxygen, water, or corrosive gas is allowed inside the package and a packaging bag with a high gas barrier is needed for protecting the content from these gases. To meet this requirement, Nitta provides high-barrier bags with a high gas barrier performance also for nitrogen sealing or atmospheric sealing.



- The packaging bags that Nitta uses have the highest gas barrier performance among clear bags.
- The bags do not contain halogen, etc, for safe burning.

Tube

Clean tube

Processed tube

PushOne fitting

QuickSeal fitting

Clean fitting/ Chemifit

Bamboo-shoot fitting

Control switch/ Detachable series

Jig/Tool/ Accessory

Technical information

Reference

Connector

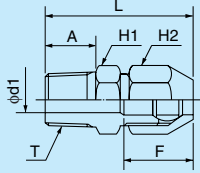

●Millimeter size type

Product number	Applicable tube outer diameter (mm)	T Thread size (R)	L (mm)	A (mm)	F Tube insertion length (mm)	H ₁ Width across flat (mm)	H ₂ Width across flat (mm)	d ₁ (mm)	Min. inner diameter (mm)	Effective cross-sectional area (mm ²)	Weight (g)
CP-C4-R1/8	4	R1/8	29.8	8.0	17	12.0	12.0	4.3	2.8	3.5	2.0
CP-C6-R1/8	6	R1/8	37.1	12.0	19	14.0	14.0	5.0	5.0	11.0	3.0
CP-C6-R1/4	6	R1/4	37.1	12.0	19	14.0	14.0	5.0	5.0	11.0	3.0
CP-C8-R1/8	8	R1/8	42.5	9.0	22	16.5	16.5	6.0	6.0	24.5	5.0
CP-C8-R1/4	8	R1/4	45.0	12.0	22	16.5	16.5	6.0	6.0	24.5	5.0
CP-C10-R1/4	10	R1/4	46.8	12.0	29	18.5	19.0	8.0	8.0	37.0	6.0
CP-C10-R3/8	10	R3/8	48.6	13.5	29	18.5	19.0	8.0	8.0	37.0	7.0
CP-C12-R3/8	12	R3/8	57.7	13.5	29	24.0	21.5	9.9	9.9	54.0	11.0
CP-C12-R1/2	12	R1/2	59.9	15.5	29	24.0	21.5	9.9	9.9	54.0	13.0

●Inch size type

Product number	Applicable tube outer diameter (inch)	T Thread size (R)	L (mm)	A (mm)	F Tube insertion length (mm)	H ₁ Width across flat (mm)	H ₂ Width across flat (mm)	d ₁ (mm)	Min. inner diameter (mm)	Effective cross-sectional area (mm ²)	Weight (g)
CP-C1/4-R1/8	1/4	R1/8	37.4	12.0	19	14.0	14.0	5.0	5.0	15.0	3.0
CP-C1/4-R1/4	1/4	R1/4	37.4	12.0	19	14.0	14.0	5.0	5.0	15.0	3.0
CP-C3/8-R1/4	3/8	R1/4	45.9	12.0	28	18.5	19.0	8.0	8.0	34.0	6.0
CP-C3/8-R3/8	3/8	R3/8	47.7	13.5	28	18.5	19.0	8.0	8.0	34.0	7.0
CP-C1/2-R3/8	1/2	R3/8	58.2	13.5	29	24.0	22.0	9.9	9.9	59.0	11.0
CP-C1/2-R1/2	1/2	R1/2	60.7	15.5	29	24.0	22.0	9.9	9.9	59.0	13.0

90 degree elbow

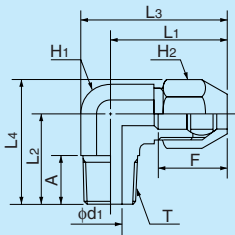

●Millimeter size type

Product number	Applicable tube outer diameter (mm)	T Thread size (R)	L ₁ (mm)	L ₂ (mm)	L ₃ (mm)	L ₄ (mm)	A (mm)	F Tube insertion length (mm)	H ₁ Width across flat (mm)	H ₂ Width across flat (mm)	d ₁ (mm)	Min. inner diameter (mm)	Effective cross-sectional area (mm ²)	Weight (g)
CP-L4-R1/8	4	R1/8	26.8	21.0	32.6	27.9	8.0	17	10.0	12.0	4.0	2.8	3.0	3.0
CP-L6-R1/8	6	R1/8	29.1	23.0	36.0	31.1	12.0	19	12.0	14.0	5.0	5.0	10.0	4.0
CP-L6-R1/4	6	R1/4	29.1	23.0	36.0	31.1	12.0	19	12.0	14.0	5.0	5.0	10.0	4.0
CP-L8-R1/8	8	R1/8	37.0	24.0	43.9	33.5	9.0	22	12.0	16.5	6.0	6.0	19.5	6.0
CP-L8-R1/4	8	R1/4	37.0	27.0	43.9	36.5	12.5	22	12.0	16.5	6.0	6.0	19.5	6.0
CP-L10-R1/4	10	R1/4	41.8	27.0	51.3	37.9	12.0	29	16.5	19.0	8.0	8.0	30.0	9.0
CP-L10-R3/8	10	R3/8	41.8	27.0	51.3	37.9	13.5	29	16.5	19.0	8.0	8.0	30.0	10.0
CP-L12-R3/8	12	R3/8	45.7	27.0	56.3	39.4	13.7	29	18.5	21.5	9.9	9.9	46.0	12.0
CP-L12-R1/2	12	R1/2	45.7	27.0	56.3	39.4	16.0	29	18.5	21.5	9.9	9.9	46.0	14.0

●Inch size type

Product number	Applicable tube outer diameter (inch)	T Thread size (R)	L ₁ (mm)	L ₂ (mm)	L ₃ (mm)	L ₄ (mm)	A (mm)	F Tube insertion length (mm)	H ₁ Width across flat (mm)	H ₂ Width across flat (mm)	d ₁ (mm)	Min. inner diameter (mm)	Effective cross-sectional area (mm ²)	Weight (g)
CP-L1/4-R1/8	1/4	R1/8	29.4	23.0	36.3	31.1	12.0	19	12.0	14.0	5.0	5.0	12.0	4.0
CP-L1/4-R1/4	1/4	R1/4	29.4	23.0	36.3	31.1	12.0	19	12.0	14.0	5.0	5.0	12.0	4.0
CP-L3/8-R1/4	3/8	R1/4	40.9	27.0	50.4	37.9	12.0	28	16.5	19.0	8.0	8.0	29.0	9.0
CP-L3/8-R3/8	3/8	R3/8	40.9	27.0	50.4	37.9	13.5	28	16.5	19.0	8.0	8.0	29.0	10.0
CP-L1/2-R3/8	1/2	R3/8	46.2	27.0	56.8	39.7	13.5	29	18.5	22.0	9.9	9.9	53.0	12.0
CP-L1/2-R1/2	1/2	R1/2	46.2	27.0	56.8	39.7	16.0	29	18.5	22.0	9.9	9.9	53.0	14.0

Tube
Clean tube
Processed tube
PushOne fitting
QuickSeal fitting
Clean fitting/Chemifit
Bamboo-shoot fitting
Control switch/Detachable series
Jig/Tool/Accessory
Technical information
Reference

Tee

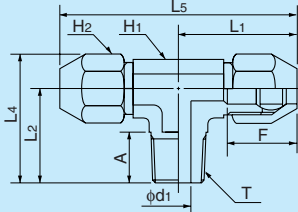

●Millimeter size type

Product number	Applicable tube outer diameter (mm)	T Thread size (R)	L1 (mm)	L2 (mm)	L4 (mm)	L5 (mm)	A (mm)	F Tube insertion length (mm)	H1 Width across flat (mm)	H2 Width across flat (mm)	d1 (mm)	Min. inner diameter (mm)	Effective cross-sectional area (mm ²)	Weight (g)
CP-T4-R1/8	4	R1/8	26.8	18.0	24.9	53.7	8.0	17	10.0	12.0	2.8	2.8	3.0	4.0
CP-T6-R1/8	6	R1/8	29.2	22.0	30.1	58.5	12.0	19	12.0	14.0	5.0	5.0	10.0	5.0
CP-T6-R1/4	6	R1/4	29.2	22.0	30.1	58.5	12.0	19	12.0	14.0	5.0	5.0	10.0	5.0
CP-T8-R1/8	8	R1/8	35.0	20.5	30.0	69.9	10.0	22	9.5	16.5	6.0	6.0	19.5	6.0
CP-T8-R1/4	8	R1/4	35.0	24.0	33.5	69.9	13.0	22	9.5	16.5	6.0	6.0	19.5	6.0
CP-T10-R1/4	10	R1/4	44.5	28.5	39.4	89.0	12.0	29	12.0	19.0	8.0	8.0	30.0	9.0
CP-T10-R3/8	10	R3/8	44.5	29.0	39.9	89.0	13.5	29	12.0	19.0	8.0	8.0	30.0	10.0
CP-T12-R3/8	12	R3/8	50.1	31.0	43.4	100.2	13.5	29	13.5	21.5	9.9	9.9	46.0	12.0
CP-T12-R1/2	12	R1/2	50.1	33.0	45.4	100.2	15.5	29	13.5	21.5	9.9	9.9	46.0	14.0

●Inch size type

Product number	Applicable tube outer diameter (inch)	T Thread size (R)	L1 (mm)	L2 (mm)	L4 (mm)	L5 (mm)	A (mm)	F Tube insertion length (mm)	H1 Width across flat (mm)	H2 Width across flat (mm)	d1 (mm)	Min. inner diameter (mm)	Effective cross-sectional area (mm ²)	Weight (g)
CP-T1/4-R1/8	1/4	R1/8	29.6	22.0	30.1	59.1	12.0	19	12.0	14.0	5.0	5.0	12.0	5.0
CP-T1/4-R1/4	1/4	R1/4	29.6	22.0	30.1	59.1	12.0	19	12.0	14.0	5.0	5.0	12.0	5.0
CP-T3/8-R1/4	3/8	R1/4	43.5	28.5	39.4	87.0	12.0	28	12.0	19.0	8.0	8.0	29.0	9.0
CP-T3/8-R3/8	3/8	R3/8	43.5	29.0	39.9	87.0	13.5	28	12.0	19.0	8.0	8.0	29.0	10.0
CP-T1/2-R3/8	1/2	R3/8	50.6	31.0	43.7	101.1	13.5	29	13.5	22.0	9.9	9.9	53.0	12.0
CP-T1/2-R1/2	1/2	R1/2	50.6	33.0	45.7	101.1	15.5	29	13.5	22.0	9.9	9.9	53.0	14.0

Service tee

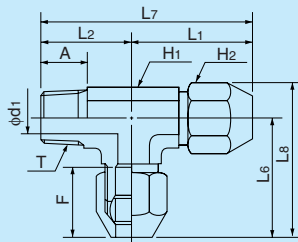

●Millimeter size type

Product number	Applicable tube outer diameter (mm)	T Thread size (R)	L1 (mm)	L2 (mm)	L6 (mm)	L7 (mm)	L8 (mm)	A (mm)	F Tube insertion length (mm)	H1 Width across flat (mm)	H2 Width across flat (mm)	d1 (mm)	Min. inner diameter (mm)	Effective cross-sectional area (mm ²)	Weight (g)
CP-ST4-R1/8	4	R1/8	26.8	18.0	26.8	44.8	33.7	8.0	17	10.0	12.0	2.8	2.8	3.0	4.0
CP-ST6-R1/8	6	R1/8	29.1	22.0	29.1	51.1	37.1	12.0	19	12.0	14.0	5.0	5.0	10.0	5.0
CP-ST6-R1/4	6	R1/4	29.1	22.0	29.1	51.1	37.1	12.0	19	12.0	14.0	5.0	5.0	10.0	5.0
CP-ST8-R1/8	8	R1/8	35.5	21.0	35.5	56.5	45.0	10.0	22	9.5	16.5	6.0	6.0	19.5	6.0
CP-ST8-R1/4	8	R1/4	35.5	23.5	35.5	59.0	45.0	13.0	22	9.5	16.5	6.0	6.0	19.5	6.0
CP-ST10-R1/4	10	R1/4	44.8	28.0	44.8	72.8	53.8	12.0	29	12.0	19.0	8.0	8.0	30.0	9.0
CP-ST10-R3/8	10	R3/8	44.8	30.0	44.8	74.8	53.8	13.5	29	12.0	19.0	8.0	8.0	30.0	9.0
CP-ST12-R3/8	12	R3/8	50.2	30.3	50.2	80.5	62.5	13.5	29	13.5	21.5	9.9	9.9	46.0	12.0
CP-ST12-R1/2	12	R1/2	50.2	32.5	50.2	82.7	62.5	15.5	29	13.5	21.5	9.9	9.9	46.0	14.0

●Inch size type

Product number	Applicable tube outer diameter (inch)	T Thread size (R)	L1 (mm)	L2 (mm)	L6 (mm)	L7 (mm)	L8 (mm)	A (mm)	F Tube insertion length (mm)	H1 Width across flat (mm)	H2 Width across flat (mm)	d1 (mm)	Min. inner diameter (mm)	Effective cross-sectional area (mm ²)	Weight (g)
CP-ST1/4-R1/8	1/4	R1/8	29.4	22.0	29.4	51.4	37.5	12.0	19	12.0	14.0	5.0	5.0	12.0	5.0
CP-ST1/4-R1/4	1/4	R1/4	29.4	22.0	29.4	51.4	37.5	12.0	19	12.0	14.0	5.0	5.0	12.0	5.0
CP-ST3/8-R1/4	3/8	R1/4	43.9	28.0	43.9	71.9	54.8	12.0	28	12.0	19.0	8.0	8.0	29.0	9.0
CP-ST3/8-R3/8	3/8	R3/8	43.9	30.0	43.9	73.9	54.8	13.5	28	12.0	19.0	8.0	8.0	29.0	9.0
CP-ST1/2-R3/8	1/2	R3/8	50.7	30.3	50.7	81.0	63.3	13.5	29	13.5	22.0	9.9	9.9	53.0	12.0
CP-ST1/2-R1/2	1/2	R1/2	50.7	32.5	50.7	83.2	63.3	16.0	29	13.5	22.0	9.9	9.9	53.0	14.0

Tube

Clean tube

Processed tube

PushOne fitting

QuickSeal fitting

Clean fitting/ Chemifit

Bamboo-shoot fitting

Control switch/ Detachable series

Jig/Tool/ Accessory

Technical information

Reference

Union connector

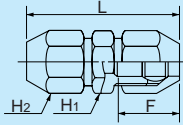

●Millimeter size type

Product number	Applicable tube outer diameter (mm)	L (mm)	F Tube insertion length (mm)	H ₁ Width across flat (mm)	H ₂ Width across flat (mm)	Min. inner diameter (mm)	Effective cross-sectional area (mm ²)	Weight (g)
CP-UC4	4	38.7	17	12.0	12.0	2.8	3.0	3.0
CP-UC6	6	43.2	19	14.0	14.0	5.0	10.0	3.0
CP-UC8	8	57.4	22	16.5	16.5	6.0	22.0	5.0
CP-UC10	10	63.2	29	18.5	19.0	8.0	35.5	9.0
CP-UC12	12	77.4	29	24.0	21.5	10.0	51.0	15.0

●Inch size type

Product number	Applicable tube outer diameter (inch)	L (mm)	F Tube insertion length (mm)	H ₁ Width across flat (mm)	H ₂ Width across flat (mm)	Min. inner diameter (mm)	Effective cross-sectional area (mm ²)	Weight (g)
CP-UC1/4	1/4	43.8	19	14.0	14.0	5.0	12.0	3.0
CP-UC3/8	3/8	61.2	28	18.5	19.0	8.0	31.5	9.0
CP-UC1/2	1/2	78.6	29	24.0	22.0	10.0	56.0	15.0

90 degree union elbow

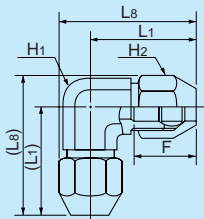

●Millimeter size type

Product number	Applicable tube outer diameter (mm)	L ₁ (mm)	L ₈ (mm)	F Tube insertion length (mm)	H ₁ Width across flat (mm)	H ₂ Width across flat (mm)	Min. inner diameter (mm)	Effective cross-sectional area (mm ²)	Weight (g)
CP-UL6	6	29.1	37.1	19	12.0	14.0	5.0	9.0	5.0
CP-UL8	8	39.0(37.0)	48.5(46.5)	22	12.0	16.5	6.0	18.5	8.0
CP-UL10	10	41.8	52.8	29	16.5	19.0	8.0	30.5	12.0
CP-UL12	12	45.7	58.0	29	18.5	21.5	10.0	44.0	16.0

☞ L₁ and L₈ of CP-UL8 have two lengths. See inside the parenthesis for another length.

●Inch size type

Product number	Applicable tube outer diameter (inch)	L ₁ (mm)	L ₈ (mm)	F Tube insertion length (mm)	H ₁ Width across flat (mm)	H ₂ Width across flat (mm)	Min. inner diameter (mm)	Effective cross-sectional area (mm ²)	Weight (g)
CP-UL1/4	1/4	29.4	37.5	19	12.0	14.0	5.0	11.5	5.0
CP-UL3/8	3/8	40.9	51.8	28	16.5	19.0	8.0	27.0	12.0
CP-UL1/2	1/2	46.2	58.8	29	18.5	22.0	10.0	49.0	16.0

Union tee

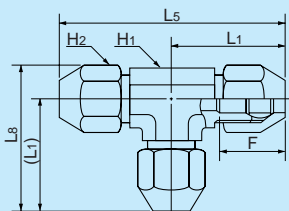

●Millimeter size type

Product number	Applicable tube outer diameter (mm)	L ₁ (mm)	L ₅ (mm)	L ₈ (mm)	F Tube insertion length (mm)	H ₁ Width across flat (mm)	H ₂ Width across flat (mm)	Min. inner diameter (mm)	Effective cross-sectional area (mm ²)	Weight (g)
CP-UT4	4	26.8	53.7	33.7	17	10.0	12.0	2.8	2.5	5.0
CP-UT6	6	29.1	58.2	37.1	19	12.0	14.0	5.0	9.0	8.0
CP-UT8	8	36.5(36.0)	71.9	46.0	22	9.5	16.5	6.0	18.5	11.0
CP-UT10	10	44.3	88.7	55.3	29	12.0	19.0	8.0	30.5	15.0
CP-UT12	12	50.1	100.2	62.5	29	13.5	21.5	10.0	44.0	20.0

☞ L₁ of CP-UT8 has two lengths. See inside the parenthesis for another length.

●Inch size type

Product number	Applicable tube outer diameter (inch)	L ₁ (mm)	L ₅ (mm)	L ₈ (mm)	F Tube insertion length (mm)	H ₁ Width across flat (mm)	H ₂ Width across flat (mm)	Min. inner diameter (mm)	Effective cross-sectional area (mm ²)	Weight (g)
CP-UT1/4	1/4	29.4	58.8	37.5	19	12.0	14.0	5.0	11.5	8.0
CP-UT3/8	3/8	43.4	86.7	54.3	28	12.0	19.0	8.0	27.0	15.0
CP-UT1/2	1/2	50.7	101.3	63.3	29	13.5	22.0	10.0	49.0	20.0

Tube

Clean tube

Processed tube

PushOne fitting

QuickSeal fitting

Clean fitting/ Chemifit

Bamboo-shoot fitting

Control switch/ Detachable series

Jig/Tool/ Accessory

Technical information

Reference

Insertion part

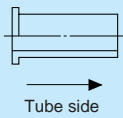

●Millimeter size type

Product number	Applicable tube outer inner diameters (mm)
CPI 6×4	6×4
CPI 8×6	8×6
CPI 10×8	10×8
CPI 12×9	12×9
CPI12×10	12×10

●Inch size type

Product number	Applicable tube outer inner diameters (mm)
CPI1/4	6.35×4.57
CPI3/8	9.53×6.99
CPI1/2	12.7×9.56

⚠ Caution When using a flexible tube such as a polyolefin resin tube, insert it first to the insertion part before connecting to a fitting.

Nut

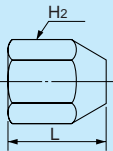

Product number	Applicable tube outer diameter		L (mm)	H2 Width across flat (mm)	Weight (g)
	(mm)	(Inch)			
CPN4	4	—	13.5	12.0	1.0
CPN6	6	1/4	15.0	14.0	1.0
CPN8	8	—	19.0	16.5	2.0
CPN10	10	3/8	22.0	21.5	2.0
CPN12	12	—	26.5	22.0	4.0
CPN1/2	—	1/2	26.5	22.0	4.0

⚠ Caution When you detach and re-attach a tube, replace the nut with a new one.

Sleeve

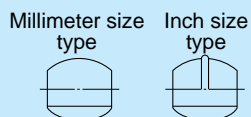

●Millimeter size type

Product number	Applicable tube outer diameter (mm)	Weight (g)
CPS4	4	0.1
CPS6	6	0.1
CPS8	8	0.2
CPS10	10	0.4
CPS12	12	0.4

●Inch size type

Product number	Applicable tube outer diameter (inch)	Weight (g)
CPS1/4	1/4	0.1
CPS3/8	3/8	0.3
CPS1/2	1/2	0.5

⚠ Caution When you detach and re-attach a tube, replace the sleeve with a new one.

Barb Type

Features

- Various shapes can be made by combining the connector and each part.
- Seal processed PT thread requires no sealing tape.

Product number example

BN 4 - PT1/8

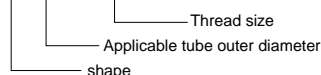

Applicable tube

Polyurethane tube



U5...P.14



Operating fluid, working temperature range

Operating fluid	Working temperature range
Air	-40°C~+80°C

Pressure condition

Maximum working pressure: 0.4MPa
Negative pressure performance: -99.975kPa

See page 34 for the common handling instructions for tube fittings.

How to attach

Insert a tube to the tube-connection part (bamboo-shoot shaped) until the tube reaches the end. The thread part is attached in the same way as the PushOne series.

Sample combinations of barb fittings

Various shapes of barb fittings can be made by combining the connector and each part.

<p>Elbow shape</p>	<p>Sample combination</p> <p>Tube size : 4×2.5 Thread size : M5</p>	<p>(Body) Elbow block BL-M5</p>	+	<p>(Thread side) Adaptor nipple BAN-M5</p>	+	<p>(Tube side) Connector BN4-M5</p>				
<p>Tee shape</p>	<p>Sample combination</p> <p>Tube size : 6×4 Thread size : R1/8</p>	<p>(Body) Tee block BT-M5</p>	+	<p>(Thread side) Adaptor nipple BAN-M5</p>	+	<p>(Tube side) Adaptor bush BAB-M5-PT1/8</p>	+	<p>(Tube side) Connector BN6-M5</p>	+	<p>(Tube side) Connector BN6-M5</p>
<p>Service tee shape</p>	<p>Sample combination</p> <p>Tube size : 3.5×2 Thread size : M5</p>	<p>(Body) Tee block BT-M5</p>	+	<p>(Thread side) Adaptor nipple BAN-M5</p>	+	<p>(Tube side) Connector BN3.5-M5</p>	+	<p>(Tube side) Connector BN3.5-M5</p>		
<p>Union elbow shape</p>	<p>Sample combination</p> <p>Tube size : 4×2.5</p>	<p>(Body) Elbow block BL-M5</p>	+	<p>(Tube side) Connector BN4-M5</p>	+	<p>(Tube side) Connector BN4-M5</p>				
<p>Union tee shape</p>	<p>Sample combination</p> <p>Tube size : 4×2.5</p>	<p>(Body) Tee block BT-M5</p>	+	<p>Connector BN4-M5</p>	+	<p>(Tube side) Connector BN4-M5</p>	+	<p>Connector BN4-M5</p>		
<p>Universal elbow shape</p>	<p>Sample combination</p> <p>Tube size : 6×4 Thread size : PT1/8</p>	<p>(Body) Universal elbow block BUVL-M5</p>	+	<p>(Thread side) Adaptor bush BAB-M5-PT1/8</p>	+	<p>(Tube side) Connector BN6-M5</p>				
<p>Universal tee shape</p>	<p>Sample combination</p> <p>Tube size : 3.5×2 Thread size : M5</p>	<p>(Body, Thread side) Universal tee block BUVT-M5</p>	+	<p>Connector BN3.5-M5</p>	+	<p>(Tube side) Connector BN3.5-M5</p>				

Connector



●Millimeter size type

Product number	Applicable tube outer×inner diameters (mm)	Thread size (M,R)	L (mm)	F Tube insertion length (mm)	d2 (mm)	Min. inner diameter (mm)	Weight (g)
BN3.5-M5	3.5×2	M5×0.8	13.5	6.5	1.0	1.0	2.0
BN4-M5	4×2.5	M5×0.8	13.5	6.5	1.5	1.5	2.0
BN6-M5	6×4	M5×0.8	15.0	8.0	3.0	2.0	2.5

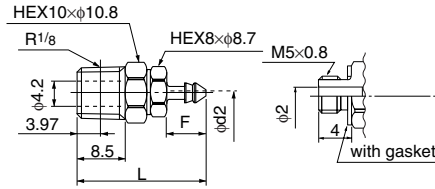

Barb type parts

Elbow block

Product number : BL-M5

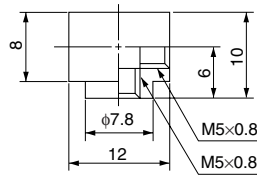

Weight 5.5g

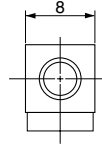

Adapter nipple

Product number : BAN-M5

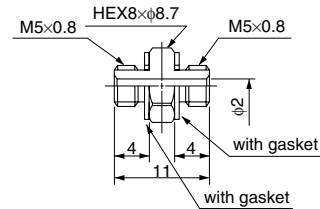

Weight 2.0g

Tee block

Product number : BT-M5

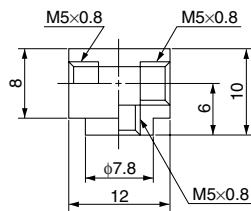

Weight 5.0g

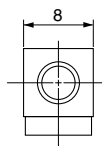

Adaptor bush

Product number : BAB-M5-PT1/8

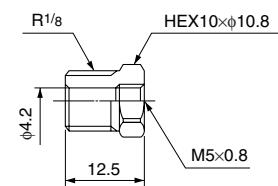

Weight 6.0g

Universal elbow block

Product number : BUVL-M5

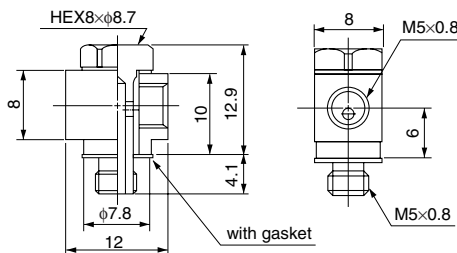

Weight 7.5g

Plug

Product number : BBP-M5

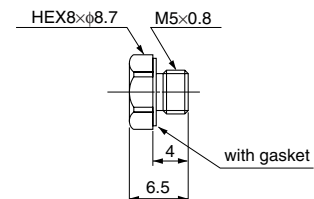

Weight 1.5g

Universal tee block

Product number : BUVT-M5

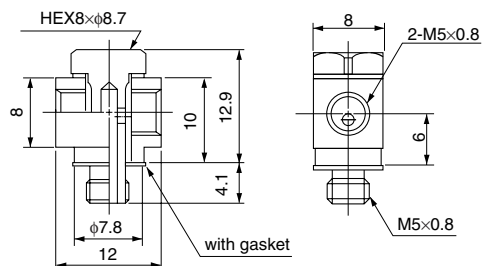

Weight 7.0g

Gasket

Product number : MRG-5-01

Thickness 0.4mm

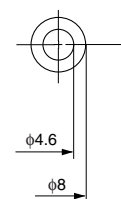
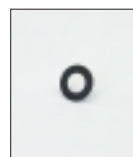

Tube

Clean tube

Processed tube

PushOne fitting

QuickSeal fitting

Clean fitting/ChemiFit

Bamboo-shoot fitting

Control switch/Detachable series

Jig/Tool/Accessory

Technical information

Reference

CONTROL

Control Switch and Detachable Series

Handling instructions for control switch and detachable series

⚠ Safety Note

This Safety Note provides indications on the correct use of the product in order to prevent harm to people and property. The indications are classified into three categories, "danger", "warning", and "caution", depending on the level of potential harm due to improper use. Each category contains important instructions on safety that should be followed in addition to the latest ISO 4414-1981(*1), JIS B 8370(1988)(*2), ISO4413 (*3), and JIS B 8361 (*4).

*1 ISO4414 Pneumatic fluid power...Recommendations for the application of equipment to transmission and control systems.

*2 JIS B 8370(1988) Pneumatic System General Rules

*3 ISO4413 Hydraulic fluid power...General rules for the application of equipment to transmission and control systems.

*4 JIS B 8361 Hydraulic System General Rules

⚠ DANGER

Where inappropriate use of this equipment may cause death or severe injury and where immediate warning of a dangerous situation is highly required.

⚠ WARNING

Where inappropriate use of this equipment may cause death or severe injury.

⚠ CAUTION

Where inappropriate use of this equipment may cause minor injury.

⚠ Before Selection

⚠ DANGER

- Cannot use for machines or equipment for life support.
- To use for machines or equipment that require extremely high safety, measures have to be taken to prevent danger in case of pulling out, burst and leakage.

⚠ WARNING

- Please contact us before using our products under conditions other than those specified in the catalog.
- Please contact us before using our products for equipment, machines, various types of vehicles, and passenger aircraft, for leisure equipment passenger transport, for medical equipment that would cause human harm in case the specifications are inappropriately followed, and for machines in contact with food or drinking water.

⚠ Selection

⚠ WARNING

- Please check that our products are used under the "use conditions" specified in the catalog.
- Do not use our products when a caustic or flammable gas is used as the fluid or is in the environment.

⚠ CAUTION

- If use conditions differ between the tube and the fitting, use them under the lower specified conditions.
- For Nitta's fitting products, use tube products that Nitta specifies or JIS B 8381-1995 on-spec products.
- When a chemical is used in fluid or the environment, see "Chemical resistance specification table". Contact us for chemical resistance of plating.
- When spatter (hot wasted metal) is likely to stick to the fittings, use flame-resistant products only. Otherwise the spatter may cause a fire.
- Couplers and nipples of the Q.D.C. 101 series and the 103 series cannot be connected to other manufacturer's products.

⚠ Installation

⚠ WARNING

- Fix tubes when installing them in a place where unexpected disconnection of the tube and connector could cause harm to people or property.

⚠ CAUTION

- Attach the control, switch, and detachable series following the instruction manual of the fitting series that has the same tube connector shape (ex. PushOne, QuickSeal, and Chemifit types).
- Do not throw or drop the control, switch, and detachable series. The impact may cause internal damage even if no outer damage is found.
- Because the connection part of the fitting may swell or crack depending on the material, check the strength of the part when connecting.
- A fitting with a sealing processed thread may swell due to the action of an operating fluid such as organic solvent, allowing fluid leakage from the thread part.
- Do not bend the pipe sharply near the tube insertion port (sleeve end) of the fitting. Keep the tube straight for twice as long as the tube diameter from the insertion port.
- Do not use a fitting with damaged thread or damaged tube insertion port.
- Nitta only guarantees products fabricated by designated companies.
- Do not give tension when installing tubes.
- When using water as the operating fluid for the fitting series that has the same tube connector shape (ex. PushOne, QuickSeal, and Chemifit types), avoid installing in a movable place.
- You cannot re-use sleeves that have QuickSeal-type tube-connector shape. Replace them with a new sleeve each time you detach.

⚠ Usage

⚠ WARNING

- Nitta's products should be handled only by designers who have sufficient knowledge of equipment, instruments and systems in which our products are to be installed, or by persons responsible for determining specifications. Test and analysis should be conducted if necessary. The designers or the responsible persons are liable for the performance and the safety of the equipment, instruments and systems.

⚠ CAUTION

- When water is used as fluid, do not allow it to freeze.
- Do not touch a tube at pressurization. Improperly treating or touching a tube at pressurization may lead to danger from unexpected breakage or leakage of fluid.
- Do not touch a tube when the operating fluid is hot. Doing so may cause burns.
- Use of the control, switch and detachable series in a place contaminated with many metal particles or dust could cause operation problems. Do not use it in such an environment.

⚠ Storage

⚠ CAUTION

- When storing unused products, make sure to keep them in a clean place to prevent dust. When fine particles such as dust enter the inside of tube products or the connected equipment, they may cause problems.
- Keep products in a dry place below 40°C avoiding direct sunlight.
- Do not use tube products that have been stored for more than one year after production.
- The packaging of clean tubes should be opened just before use. Store the tubes in a box in a clean place in a dust-free environment.

⚠ Maintenance and Inspection

⚠ CAUTION

- Before handling or removing Nitta's products, be sure to check the safety by shutting off the power supply, stopping the pressure supply, evacuating pressurized air in the pipe, and terminating the operation of equipment, instruments, and systems.
- Please be sure to make periodic inspection. Confirm that there is no degradation such as outer damage, corrosion, and abrasion and replace any damaged piping.

⚠ Disposal

⚠ CAUTION

- Dispose of unnecessary products as industrial waste or have them disposed of by a waste disposal firm. In particular, incineration of products containing fluorocarbon may generate a toxic pyrolysis gas.

Tube

Clean tube

Processed tube

PushOne fitting

QuickSeal fitting

Clean fitting/ Chemifit

Bamboo-shoot fitting

Control switch/ Detachable series

Jig/Tool/ Accessory

Technical information

Reference

CONTROL INDEX

Tube

Clean tube

Processed tube

PushOne fitting

QuickSeal fitting

Clean fitting/
Chemifit

Bamboo-shoot fitting

Control switch/
Detachable series

Jig/Tool/
Accessory

Technical information

Reference

Control series

Compact speed controller



P.144

- Smaller than the conventional model
- PushOne® connection
- Electroless nickel plated
- Sealing-processed R thread

Control series

Chemifit® C1 speed controller



P.146

- Suitable for environment (atmosphere) that requires chemical-resistance
- PushOne® connection
- Inline type (ESU) allows central control on the piping line.

Control series

Speed controller



P.148

- PushOne® connection
- Universal type (ESD) can be connected in any direction.
- Inline type (ESU) allows central control on the piping line.
- Electroless nickel plated
- Sealing-processed R thread

Switch series

Ball valve



P.151

- Realizing compact piping
- PushOne® connection
- Position of handle can be changed.
- Nickel plated

Control series

Throttle valve



P.154

- Fine control of flow rate
- Inline type (ESU) allows central control on the piping line.
- PushOne® connection
- Electroless nickel plated

Miniature valve



P.156

- Easy flow rate control
- PushOne® connection for millimeter size type (quick seal type for inch size type)

Switch series

Valve built-in connector



P.159

- Valve inside fitting is opened/closed by attaching/detaching the tube
- PushOne® connection
- Electroless nickel plated

Detachable series

Q.D.C 101



P.160

- Push-To-Connect type
- Automatic opening/closing valve inside the coupler
- PushOne® fitting integrated types available

Q.D.C 103



P.163

- Push-To-Connect type
- Automatic opening/closing valve inside the coupler
- Smaller than 101 series
- Electroless nickel plated

Compact Speed Controller

PushOne® Type

Features

- Smaller than the conventional model
- Easy fine adjustment at low flow rate
Compact size with the maximum flow rate comparable to that of the conventional model. (See the graph.)
- PushOne® connection of tube
Jig and tool not required for connecting the tubes
- Flame-resistant resin (compliant V-0 of UL94 standard)
Made of flame-resistant resin PBT. High self-extinguishing performance is compliant with V-0 of UL94 standard. Usable under an environment with spatters.
- Electroless nickel plated
Preventing degradation of surface and dissolution of copper ions into fluid.
- Sealing-processed R thread.
Sealing tape is not required.



[Comparison of control flow with the conventional model]
For elbow type with φ6 tube and R1/8 thread

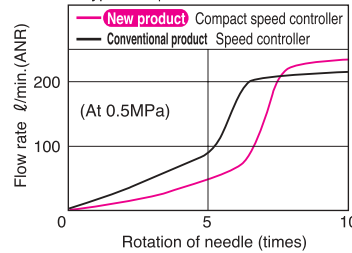

Cross-sectional structure diagram

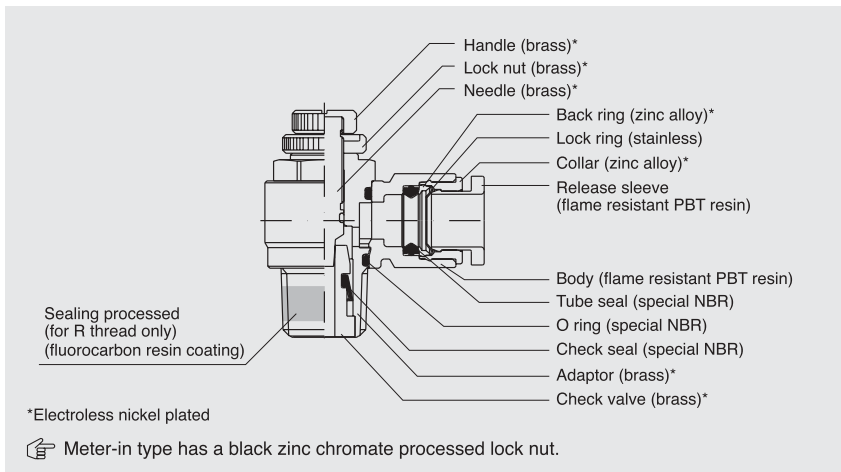

Product number example

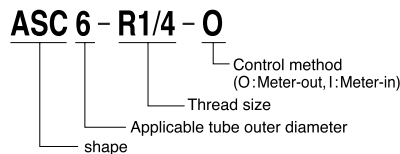

Distinction of Meter-out/in types



Meter-out/in types are distinguished by the color of the lock nut.

Applicable tube

Polyurethane tube	Nylon tube	Flame-resistant tube	Polyolefine resin tube
U2•••P.12 U1•••P.13	N2•••P.15 N5•••P.16 N1•••P.17	FS•••••P.20 FW•••••P.21 FWU•••P.22	PL•••••P.26 PN•••••P.27

(*1) Combinatory use of PL or PN tube and compact speed controller mixes general and clean type performances.
When using them in a clean environment, pay attention to the clean level that could be lowered.

Operating fluid, working temperature range

Operating fluid	Working temperature range
Air	+5°C~+60°C

Pressure condition

Maximum working pressure: 1.0MPa

Handling instructions

- ⚠ **Caution** When the working conditions of tubes and fittings differ, use them under the lower specified conditions.
 - ⚠ **Caution** Tighten the lock nut and handle by hand, not by using a spanner.
 - ⚠ **Caution** The needle part stops when fully opened. Forced rotation could cause damage.
 - ⚠ **Caution** Cannot be used at a negative pressure.
 - ⚠ **Caution** Be sure to check the air flow direction when attaching a speed controller to equipment.
 - ⚠ **Caution** Do not bend the pipe sharply near the tube insertion port (sleeve end) of the fitting. Keep the tube straight for twice as long as the tube diameter from the insertion port.
 - ⚠ **Caution** Cannot be used for sealing purpose because the allowable leakage at fully opened needle is set at 50l/min. (JIS B 8376 compliant)
- 📖 See page142 for the common handling instructions for control, switch and detachable series products.

Size comparison

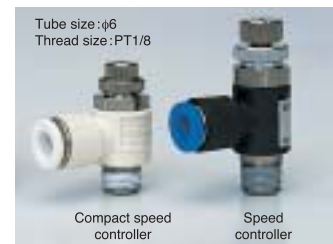

Control mechanism

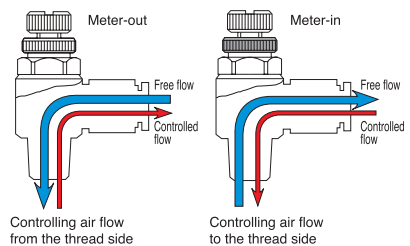

Reference

- Flow characteristic graph.....P.171
- UL-94 standard flame test.....P.204

Tube
Clean tube
Processed tube
PushOne fitting
QuickSeal fitting
Clean fitting/Chemifit
Bamboo-shoot fitting
Control switch/Detachable series
Jig/Tool/Accessory
Technical information
Reference

Elbow type

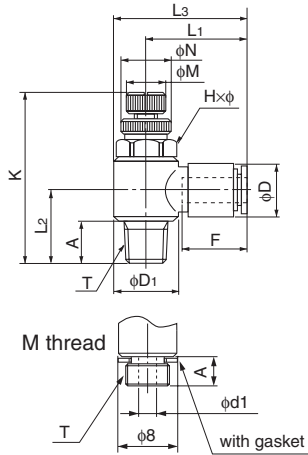

●Millimeter size type

Product number	Applicable tube outer diameter (mm)	T Thread size (M,R)	L1 (mm)	L2 (mm)	L3 (mm)	K		A (mm)	F Tube insertion length (mm)	Hxφ Width across flat (mm)	N (mm)	M (mm)	D (mm)	D1 (mm)	Weight (g)
						Full open (mm)	Full closed (mm)								
ASC4-M5-O	4	M5×0.8	18.0	10.1	22.8	28.6	25.8	3.4	13.5	8.0×9.0	8.0	5.0	9.8	9.6	8.0
ASC4-M5-I	4	M5×0.8	18.0	10.1	22.8	28.6	25.8	3.4	13.5	8.0×9.0	8.0	5.0	9.8	9.6	8.0
ASC4-R1/8-O	4	R1/8	20.1	13.7	27.2	36.0	31.0	7.3	13.5	12.0×13.5	11.0	8.0	9.8	14.2	19.0
ASC4-R1/8-I	4	R1/8	20.1	13.7	27.2	36.0	31.0	7.3	13.5	12.0×13.5	11.0	8.0	9.8	14.2	19.0
ASC6-M5-O	6	M5×0.8	20.3	10.1	25.1	28.6	25.8	3.4	15.0	8.0×9.0	8.0	5.0	12.6	9.6	9.0
ASC6-M5-I	6	M5×0.8	20.3	10.1	25.1	28.6	25.8	3.4	15.0	8.0×9.0	8.0	5.0	12.6	9.6	9.0
ASC6-R1/8-O	6	R1/8	21.8	13.7	28.9	36.0	31.0	7.3	15.0	12.0×13.5	11.0	8.0	12.6	14.2	20.0
ASC6-R1/8-I	6	R1/8	21.8	13.7	28.9	36.0	31.0	7.3	15.0	12.0×13.5	11.0	8.0	12.6	14.2	20.0
ASC6-R1/4-O	6	R1/4	23.6	18.2	32.9	40.3	35.3	10.8	15.0	14.0×15.8	13.0	10.0	12.6	18.5	33.0
ASC6-R1/4-I	6	R1/4	23.6	18.2	32.9	40.3	35.3	10.8	15.0	14.0×15.8	13.0	10.0	12.6	18.5	33.0
ASC8-R1/8-O	8	R1/8	26.6	13.7	33.7	36.0	31.0	7.3	16.0	12.0×13.5	11.0	8.0	14.6	14.2	21.0
ASC8-R1/8-I	8	R1/8	26.6	13.7	33.7	36.0	31.0	7.3	16.0	12.0×13.5	11.0	8.0	14.6	14.2	21.0
ASC8-R1/4-O	8	R1/4	24.9	18.2	34.1	40.3	35.3	10.8	16.0	14.0×15.8	13.0	10.0	14.6	18.5	34.0
ASC8-R1/4-I	8	R1/4	24.9	18.2	34.1	40.3	35.3	10.8	16.0	14.0×15.8	13.0	10.0	14.6	18.5	34.0
ASC8-R3/8-O	8	R3/8	26.9	19.9	38.2	46.3	41.3	11.1	16.0	19.0×21.0	16.0	13.0	14.6	22.6	62.0
ASC8-R3/8-I	8	R3/8	26.9	19.9	38.2	46.3	41.3	11.1	16.0	19.0×21.0	16.0	13.0	14.6	22.6	62.0
ASC10-R1/8-O	10	R1/8	30.4	13.7	37.5	36.0	31.0	7.3	19.0	12.0×13.5	11.0	8.0	17.5	14.2	23.0
ASC10-R1/8-I	10	R1/8	30.4	13.7	37.5	36.0	31.0	7.3	19.0	12.0×13.5	11.0	8.0	17.5	14.2	23.0
ASC10-R1/4-O	10	R1/4	31.5	18.2	40.7	40.3	35.3	10.8	19.0	14.0×15.8	13.0	10.0	17.5	18.5	37.0
ASC10-R1/4-I	10	R1/4	31.5	18.2	40.7	40.3	35.3	10.8	19.0	14.0×15.8	13.0	10.0	17.5	18.5	37.0
ASC10-R3/8-O	10	R3/8	30.3	19.9	41.6	46.3	41.3	11.1	19.0	19.0×21.0	16.0	13.0	17.5	22.6	65.0
ASC10-R3/8-I	10	R3/8	30.3	19.9	41.6	46.3	41.3	11.1	19.0	19.0×21.0	16.0	13.0	17.5	22.6	65.0
ASC10-R1/2-O	10	R1/2	32.4	24.5	46.0	54.5	49.5	14.4	19.0	24.0×26.0	20.0	16.0	17.5	27.4	109.0
ASC10-R1/2-I	10	R1/2	32.4	24.5	46.0	54.5	49.5	14.4	19.0	24.0×26.0	20.0	16.0	17.5	27.4	109.0
ASC12-R3/8-O	12	R3/8	37.7	19.9	49.0	46.3	41.3	11.1	20.0	19.0×21.0	16.0	13.0	20.0	22.6	67.0
ASC12-R3/8-I	12	R3/8	37.7	19.9	49.0	46.3	41.3	11.1	20.0	19.0×21.0	16.0	13.0	20.0	22.6	67.0
ASC12-R1/2-O	12	R1/2	33.7	24.5	47.4	54.5	49.5	14.4	20.0	24.0×26.0	20.0	16.0	20.0	27.4	111.0
ASC12-R1/2-I	12	R1/2	33.7	24.5	47.4	54.5	49.5	14.4	20.0	24.0×26.0	20.0	16.0	20.0	27.4	111.0

Universal type

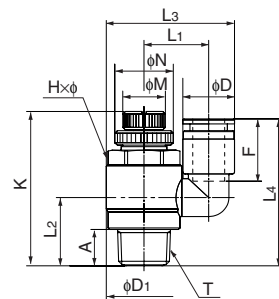

●Millimeter size type

Product number	Applicable tube outer diameter (mm)	T Thread size (M,R)	L1 (mm)	L2 (mm)	L3 (mm)	L4 (mm)	K		A (mm)	F Tube insertion length (mm)	Hxφ Width across flat (mm)	N (mm)	M (mm)	D (mm)	D1 (mm)	Weight (g)
							Full open (mm)	Full closed (mm)								
ASD4-M5-O	4	M5×0.8	9.9	10.1	18.5	24.5	28.6	25.8	3.4	11.0	8.0×9.0	8.0	5.0	8.0	9.6	8.0
ASD4-M5-I	4	M5×0.8	9.9	10.1	18.5	24.5	28.6	25.8	3.4	11.0	8.0×9.0	8.0	5.0	8.0	9.6	8.0
ASD4-R1/8-O	4	R1/8	12.2	13.7	23.1	28.0	36.0	31.0	7.3	11.0	12.0×13.5	11.0	8.0	8.0	14.2	18.0
ASD4-R1/8-I	4	R1/8	12.2	13.7	23.1	28.0	36.0	31.0	7.3	11.0	12.0×13.5	11.0	8.0	8.0	14.2	18.0
ASD6-M5-O	6	M5×0.8	9.9	10.1	19.5	25.9	28.6	25.8	3.4	12.0	8.0×9.0	8.0	5.0	10.0	9.6	8.0
ASD6-M5-I	6	M5×0.8	9.9	10.1	19.5	25.9	28.6	25.8	3.4	12.0	8.0×9.0	8.0	5.0	10.0	9.6	8.0
ASD6-R1/8-O	6	R1/8	12.2	13.7	24.1	29.4	36.0	31.0	7.3	12.0	12.0×13.5	11.0	8.0	10.0	14.2	19.0
ASD6-R1/8-I	6	R1/8	12.2	13.7	24.1	29.4	36.0	31.0	7.3	12.0	12.0×13.5	11.0	8.0	10.0	14.2	19.0
ASD6-R1/4-O	6	R1/4	14.3	17.1	28.4	32.9	40.3	35.3	10.8	12.0	14.0×15.8	13.0	10.0	10.0	18.5	32.0
ASD6-R1/4-I	6	R1/4	14.3	17.1	28.4	32.9	40.3	35.3	10.8	12.0	14.0×15.8	13.0	10.0	10.0	18.5	32.0
ASD8-R1/8-O	8	R1/8	16.1	14.4	30.5	35.1	36.0	31.0	7.3	16.0	12.0×13.5	11.0	8.0	14.6	14.2	22.0
ASD8-R1/8-I	8	R1/8	16.1	14.4	30.5	35.1	36.0	31.0	7.3	16.0	12.0×13.5	11.0	8.0	14.6	14.2	22.0
ASD8-R1/4-O	8	R1/4	18.2	18.0	34.8	38.7	40.3	35.3	10.8	16.0	14.0×15.8	13.0	10.0	14.6	18.5	36.0
ASD8-R1/4-I	8	R1/4	18.2	18.0	34.8	38.7	40.3	35.3	10.8	16.0	14.0×15.8	13.0	10.0	14.6	18.5	36.0
ASD8-R3/8-O	8	R3/8	20.3	18.7	38.9	39.4	46.3	41.3	11.1	16.0	19.0×21.0	16.0	13.0	14.6	22.6	64.0
ASD8-R3/8-I	8	R3/8	20.3	18.7	38.9	39.4	46.3	41.3	11.1	16.0	19.0×21.0	16.0	13.0	14.6	22.6	64.0
ASD10-R1/4-O	10	R1/4	18.2	18.0	36.2	42.6	40.3	35.3	10.8	19.0	14.0×15.8	13.0	10.0	17.5	18.5	38.0
ASD10-R1/4-I	10	R1/4	18.2	18.0	36.2	42.6	40.3	35.3	10.8	19.0	14.0×15.8	13.0	10.0	17.5	18.5	38.0
ASD10-R3/8-O	10	R3/8	20.3	18.7	40.3	43.3	46.3	41.3	11.1	19.0	19.0×21.0	16.0	13.0	17.5	22.6	66.0
ASD10-R3/8-I	10	R3/8	20.3	18.7	40.3	43.3	46.3	41.3	11.1	19.0	19.0×21.0	16.0	13.0	17.5	22.6	66.0

Tube

Clean tube

Processed tube

PushOne fitting

QuickSeal fitting

Clean fitting/Chemifit

Bamboo-shoot fitting

Control switch/Detachable series

Jig/Tool/Accessory

Technical information

Reference

Chemifit® C1 Speed Controller

PushOne® Type

Features

- Suitable for environment (atmosphere) that requires chemical-resistance
Mostly made of special polypropylene resin and SUS304. Special EPDM is used for sealing material.
- PushOne® connection of tube
Jig and tool not required for connecting the tubes
- Inline type (ESU) allows central control on a pipe line.
Various kinds of piping is possible by fixing with connector pins and brackets.

Cross-sectional structure diagram

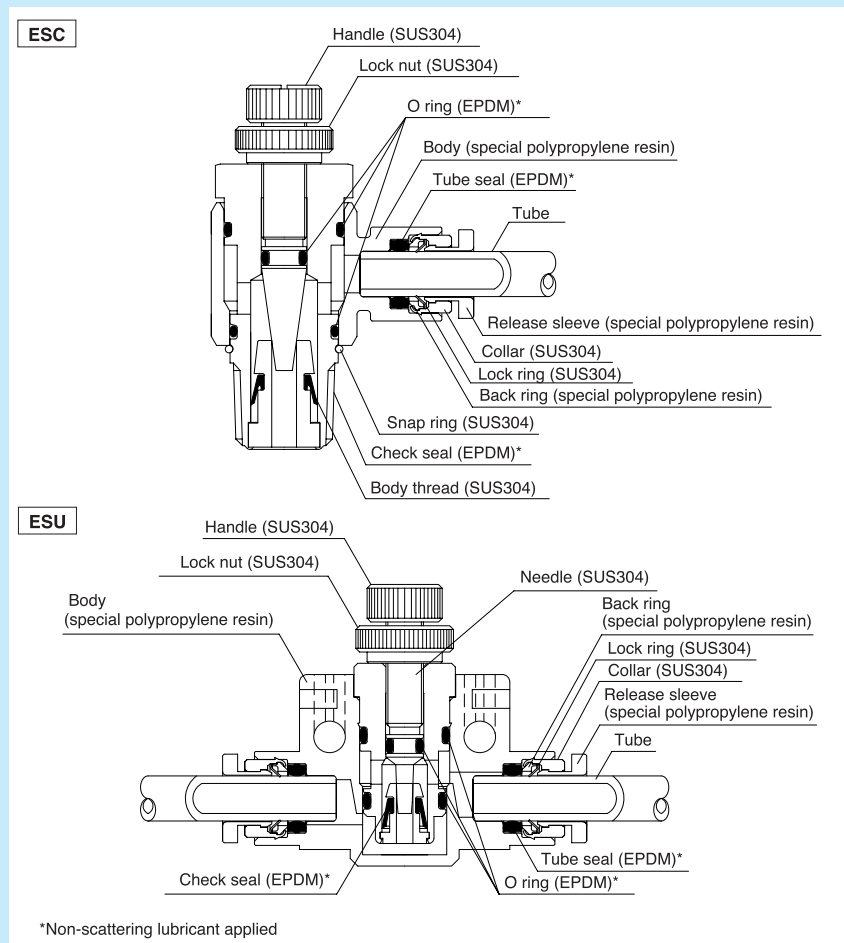

Operating fluid, working temperature range

Operating fluid	Working temperature range
Air	+5°C~+60°C

Pressure condition

Maximum working pressure: 0.7MPa

Relation between the working temperature and the maximum working pressure

Maximum working pressure varies with working temperature (environmental temperature). For use at an abnormal temperature, always check the maximum working pressure change in the graph below and keep pressure within the range.

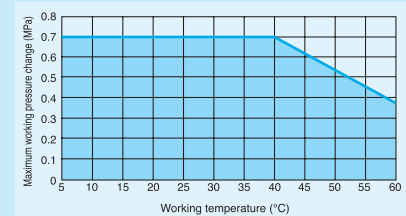

Handling instructions

- ⚠ **Caution** When the working conditions of tubes and fittings differ, use them under the lower specified conditions.
- ⚠ **Caution** Tighten the lock nut and handle by hand, not by using a spanner.
- ⚠ **Caution** The needle part stops when fully opened. Forced rotation could cause damage.
- ⚠ **Caution** Cannot be used at a negative pressure.
- ⚠ **Caution** Non-scattering lubricant is applied to some parts. Contact us for detail.
- ⚠ **Caution** Be sure to check the air flow direction when attaching a speed controller to equipment.
- ⚠ **Caution** Do not bend the pipe sharply near the tube insertion port (sleeve end) of the fitting. Keep the tube straight for twice as long as the tube diameter from the insertion port.
- ⚠ **Caution** Cannot be used for sealing purpose because the allowable leakage at fully opened needle is set at 50l/min. (JIS B 8376 compliant)

👉 See page 142 for the common handling instructions for control, switch and detachable series products.

Control mechanism

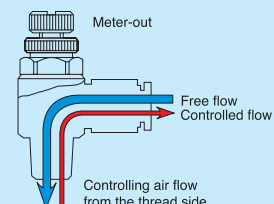

Reference

Flow characteristic graph.....P.173

Product number example

ESC 6 - R1/4 - O - C1SG

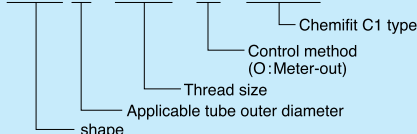

Inline type connection



Inline type controllers can be connected with a connector pin.

Applicable tube

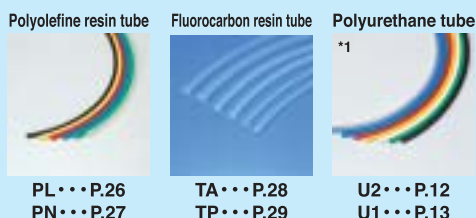

(*1) Combinatory use of U2 or U1 tube and Chemifit C1 speed controller mixes general and clean type performances.
When using them in a clean environment, pay attention to the clean level that could be lowered.

Elbow type

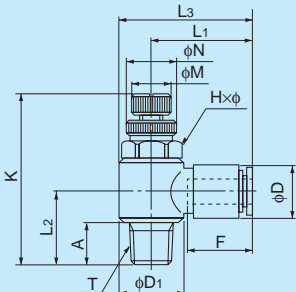

●Millimeter size type

Product number	Applicable tube outer diameter (mm)	T Thread size (R)	L ₁ (mm)	L ₂ (mm)	L ₃ (mm)	K		A (mm)	F Tube insertion length (mm)	H×φ Width across flat (mm)	N (mm)	M (mm)	D (mm)	D ₁ (mm)	Weight (g)
						Full open (mm)	Full closed (mm)								
ESC4-R1/8-O-C1SG	4	R1/8	22.2	17.7	30.6	46.8	42.0	9.7	13	13.0×14.0	13.0	10.0	10.0	13.5	26.0
ESC6-R1/8-O-C1SG	6	R1/8	22.4	17.7	30.0	46.8	42.0	9.7	15	13.0×14.0	13.0	10.0	13.0	13.5	27.0
ESC6-R1/4-O-C1SG	6	R1/4	24.4	23.1	34.9	55.2	48.7	13.6	15	17.0×18.3	13.0	10.0	13.0	19.4	51.0
ESC8-R1/8-O-C1SG	8	R1/8	23.6	17.7	31.6	46.8	42.0	9.7	16	13.0×14.0	13.0	10.0	15.0	13.5	29.0
ESC8-R1/4-O-C1SG	8	R1/4	25.6	23.1	36.5	55.2	48.7	13.6	16	17.0×18.3	13.0	10.0	15.0	19.4	52.0
ESC8-R3/8-O-C1SG	8	R3/8	27.6	24.6	40.8	59.0	51.5	14.1	16	21.0×22.6	16.0	13.0	15.0	24.0	84.0
ESC10-R1/4-O-C1SG	10	R1/4	29.0	23.1	39.4	55.2	48.7	13.6	19	17.0×18.3	13.0	10.0	18.0	19.4	55.0
ESC10-R3/8-O-C1SG	10	R3/8	31.0	24.6	43.7	59.0	51.5	14.1	19	21.0×22.6	16.0	13.0	18.0	24.0	87.0
ESC12-R3/8-O-C1SG	12	R3/8	31.8	24.6	44.7	59.0	51.5	14.1	20	21.0×22.6	16.0	13.0	20.5	28.0	116.0

Inline type

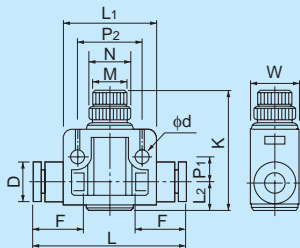

●Millimeter size type

Product number	Applicable tube outer diameter (mm)	L (mm)	L ₁ (mm)	L ₂ (mm)	P ₁ (mm)	P ₂ (mm)	K		F Tube insertion length (mm)	N (mm)	M (mm)	D (mm)	d (mm)	W (mm)	Weight (g)
							Full open (mm)	Full closed (mm)							
ESU4-C1SG	4	39.2	20.0	6.4	6.0	14.0	29.5	26.9	13	8.0	5.0	9.7	3.2	10.6	11.0
ESU6-C1SG	6	46.4	28.0	9.0	8.2	20.0	43.5	39.8	15	13.0	10.0	12.5	4.2	15.0	32.0
ESU8-C1SG	8	54.0	30.0	10.3	9.2	22.0	47.7	42.1	16	13.0	10.0	14.5	4.2	17.6	48.0

JIS symbol mark

JIS symbols are marked in both sides of the body.

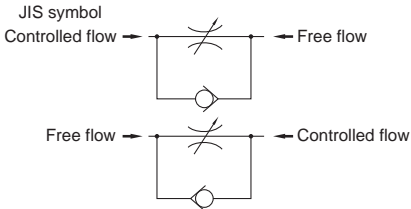

Control direction mark

Control directions are marked by arrows on the top of the body.

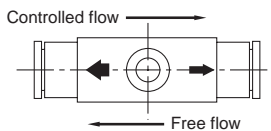

Connector pin (polypropylene resin)



●Connector pin

Product number	Applicable fitting product number
HPN4-C1	ESU4-C1SG
HPN6-C1	ESU6-C1SG
	ESU8-C1SG

Bracket (SUS304)

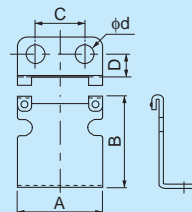

●Bracket

Product number	Applicable fitting product number	A (mm)	B (mm)	C (mm)	D (mm)	d (mm)
SBRK4	ESU4-C1SG	18.0	18.5	10.0	6.5	5.0
SBRK6	ESU6-C1SG	24.0	26.0	14.0	6.5	5.0
SBRK8	ESU8-C1SG	26.0	30.0	14.0	6.5	5.0

Tube

Clean tube

Processed tube

PushOne fitting

QuickSeal fitting

Clean fitting/Chemifit

Bamboo-shoot fitting

Control switch/ Detachable series

Jig/Tool/Accessory

Technical information

Reference

Speed Controller

PushOne® Type



Features

- **PushOne® connection of tube**
Jig and tool not required for connecting the tubes
- **Central controllable on a pipe line.**
Various kinds of piping is possible by fixing with connector pins and brackets.
- **Electroless nickel plated**
Preventing degradation of surface and dissolution of copper ions into fluid
- **Flame-resistant resin (compliant V-0 of UL94 standard)**
Made of flame-resistant resin PBT. High self-extinguishing performance is compliant with V-0 of UL94 standard. Usable under an environment with spatters.

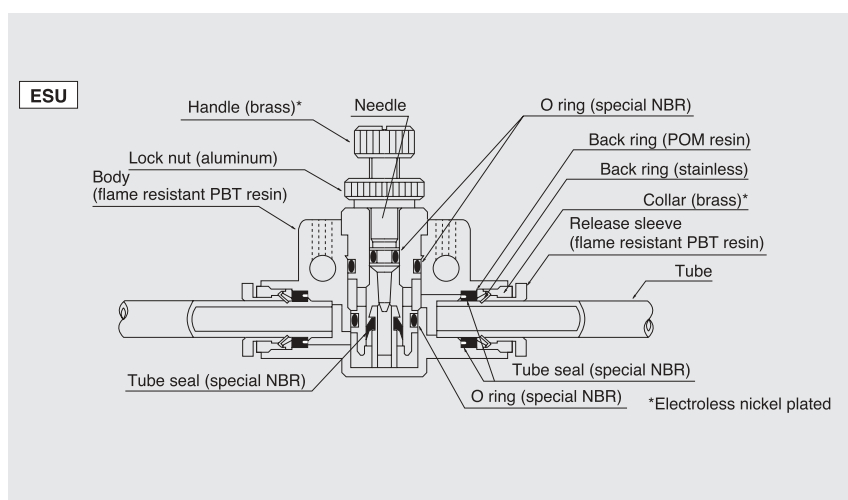
Cross-sectional structure diagram

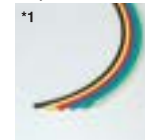
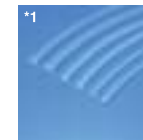

Applicable tube

Polyurethane tube	Nylon tube	Flame-resistant tube	Polyolefine resin tube	Fluorocarbon resin tube
				
U2···P.12 U1···P.13 U5···P.14	N2···P.15 N5···P.16 N1···P.17	FS····P.20 FW····P.21 FWU···P.22	PL···P.26 PN···P.27	TA···P.28 TP···P.29

(*1) Combinatory use of PL, PN, TA or TP tube and Speed controller mixes general and clean type performances.
When using them in a clean environment, pay attention to the clean level that could be lowered.

Operating fluid, working temperature range

Operating fluid	Working temperature range
Air	+5°C~+60°C

Pressure condition

Maximum working pressure: 1.0MPa

Handling instructions

- ⚠ **Caution** When the working conditions of tubes and fittings differ, use them under the lower specified conditions.
 - ⚠ **Caution** Tighten the lock nut and handle by hand, not by using a spanner.
 - ⚠ **Caution** The needle part stops when fully opened. Forced rotation could cause damage.
 - ⚠ **Caution** Cannot be used at a negative pressure.
 - ⚠ **Caution** Be sure to check the air flow direction when attaching a speed controller to equipment.
 - ⚠ **Caution** Do not bend the pipe sharply near the tube insertion port (sleeve end) of the fitting. Keep the tube straight for twice as long as the tube diameter from the insertion port.
 - ⚠ **Caution** Cannot be used for sealing purpose because the allowable leakage at fully opened needle is set at 50l/min. (JIS B 8376 compliant)
- 👉 See page142 for the common handling instructions for control, switch and detachable series products.

Inline type connection



Controllers can be connected with a connector pin.

Reference

Flow characteristic graph·····P.175
UL-94 standard flame test·····P.204

Inline type

●Millimeter size type



Product number	Applicable tube outer diameter (mm)	L (mm)	L ₁ (mm)	L ₂ (mm)	P ₁ (mm)	P ₂ (mm)	K		F Tube insertion length (mm)	N (mm)	M (mm)	D (mm)	d (mm)	W (mm)	Weight (g)
							Full open (mm)	Full closed (mm)							
ESU4	4	39.2	20.0	6.4	6.0	14.0	29.5	26.9	13	8.0	5.0	9.7	3.2	10.6	11.0
ESU6	6	46.4	28.0	9.0	8.2	20.0	43.5	39.8	15	13.0	10.0	12.5	4.2	15.0	32.0
ESU8	8	54.0	30.0	10.3	9.2	22.0	47.7	42.1	16	13.0	10.0	14.5	4.2	17.6	48.0

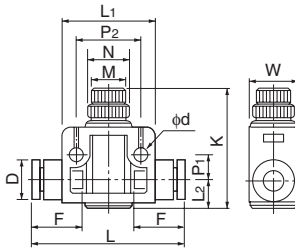

JIS symbol mark

JIS symbols are marked in both sides of the body.

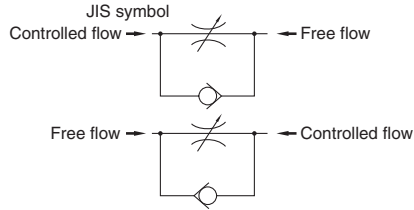

Control direction mark

Control directions are marked by arrows on the top of the body.

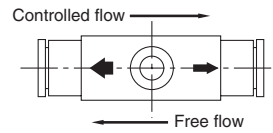

Connector pin

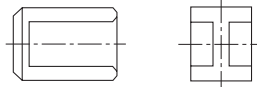

●Connector pin

Product number	Applicable fitting product number
HPN4	ESU4
HPN6	ESU6
	ESU8

Bracket

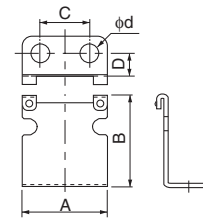

●Bracket

Product number	Applicable fitting product number	A (mm)	B (mm)	C (mm)	D (mm)	d (mm)
BRK4	ESU4	18.0	18.5	10.0	6.5	5.0
BRK6	ESU6	24.0	26.0	14.0	6.5	5.0
BRK8	ESU8	26.0	30.0	14.0	6.5	5.0

Tube

Clean tube

Processed tube

PushOne fitting

QuickSeal fitting

Clean fitting/Chemifit

Bamboo-shoot fitting

Control switch/Detachable series

Jig/Tool/Accessory

Technical information

Reference

Reference

Technical information

Jig/Tool/
Accessory

**Control switch/
Detachable
series**

Bamboo-
shoot fitting

Clean fitting/
Chemifit

QuickSeal
fitting

PushOne
fitting

Processed
tube

Clean tube

Tube

Ball Valve

PushOne® Type

Features

- **Realizing compact piping**
Integrated space-saving ball valve and PushOne fitting realizes compact piping.
- **PushOne® connection of tube**
Jig and tool not required for connecting the tubes
- **Position of handle can be changed.**
Handle can be re-attached in different position if it hits something when opened or closed.
- **Nickel plated**
Preventing degradation of surface and dissolution of copper ions into fluid

Cross-sectional structure diagram

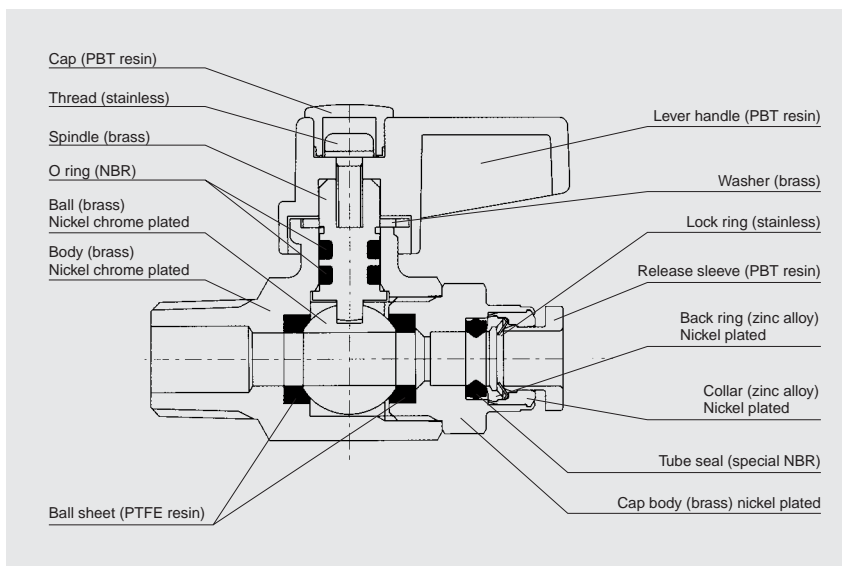



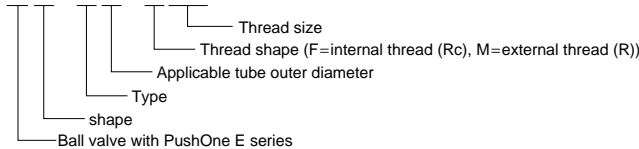

Product number example

VS-E6-F1/4



Applicable tube

Polyurethane tube	Nylon tube	Polyolefine resin tube	Fluorocarbon resin tube
			
U2...P.12 U1...P.13 U5...P.14	N2...P.15 N5...P.16 N1...P.17	PL...P.26 PN...P.27	TA...P.28 TP...P.29

(*1) Combinatory use of PL, PN, TA or TP tube and ball valve mixes general and clean type performances.
When using them in a clean environment, pay attention to the clean level that could be lowered.



Operating fluid, working temperature range





Operating fluid	Working temperature range
Air	-20°C~+80°C
Water	-0°C~+40°C

Pressure condition

Maximum working pressure: 1.0MPa

Change of open/close position of handle

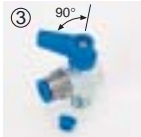
Position of the lever handle can be changed when the handle could be interfered with any objects to open or close with 90 degree.

-  Detach the cap and the thread inside.
-  Detach the lever handle.
-  Attach the lever handle at discretional position and then confirm that the handle can be opened or closed with 90 degree smoothly before tightening up of the thread.
-  Attach the cap again

Handling instructions

- ⚠ **Caution** When the working conditions of tubes and fittings differ, use them under the lower specified conditions.
 - ⚠ **Caution** When water is used as the operating fluid, do not allow it to freeze.
 - ⚠ **Caution** Use the valve at fully open or closed position, not at an intermediate position.
 - ⚠ **Caution** Do not bend the pipe sharply near the tube insertion port (sleeve end) of the fitting. Keep the tube straight for twice as long as the tube diameter from the insertion port.
 - ⚠ **Caution** Cannot be used at a negative pressure.
- 📖 See page142 for the common handling instructions for control, switch and detachable series products.

Straight type



●Internal thread

Product number	Applicable tube outer diameter (mm)	T Thread size (Rc)	L ₁ (mm)	L ₂ (mm)	L ₃ (mm)	L ₄ (mm)	LH (mm)	F Tube insertion length (mm)	D ₁ (mm)	D ₂ (mm)	H (mm)	Effective cross-sectional area (mm ²)	Weight (g)
VS-E6-F1/8	6	Rc1/8	29.0	20.5	24.0	44.5	25.0	15	6.0	5.0	17	—	—
VS-E6-F1/4	6	Rc1/4	29.0	22.5	24.0	46.5	25.0	15	6.0	5.0	17	—	—
VS-E8-F1/8	8	Rc1/8	29.0	20.5	25.0	45.5	25.0	16	6.0	6.0	17	—	—
VS-E8-F1/4	8	Rc1/4	29.0	22.5	25.0	47.5	25.0	16	6.0	6.0	17	—	—
VS-E8-F3/8	8	Rc3/8	30.5	23.0	27.0	50.0	25.0	16	7.5	6.0	22	—	—
VS-E10-F1/4	10	Rc1/4	29.0	22.5	28.0	50.5	25.0	19	6.0	6.0	17	—	—
VS-E10-F3/8	10	Rc3/8	30.5	23.0	29.5	52.5	25.0	19	7.5	7.5	22	—	—
VS-E12-F3/8	12	Rc3/8	30.5	23.0	31.5	54.5	25.0	20	7.5	7.5	22	—	—

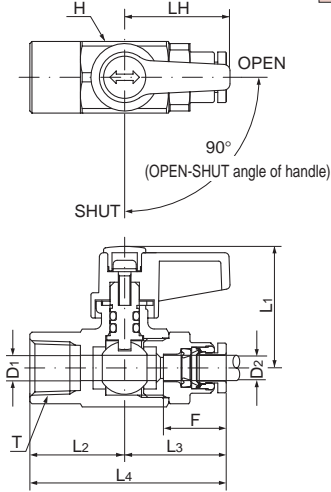

●External thread

Product number	Applicable tube outer diameter (mm)	T Thread size (R)	L ₁ (mm)	L ₂ (mm)	L ₃ (mm)	L ₄ (mm)	LH (mm)	F Tube insertion length (mm)	D ₁ (mm)	D ₂ (mm)	H (mm)	Effective cross-sectional area (mm ²)	Weight (g)
VS-E6-M1/8	6	R1/8	29.0	20.5	24.0	44.5	25.0	15	6.0	5.0	17	—	—
VS-E6-M1/4	6	R1/4	29.0	22.5	24.0	46.5	25.0	15	6.0	5.0	17	—	—
VS-E8-M1/8	8	R1/8	29.0	20.5	25.0	45.5	25.0	16	6.0	6.0	17	—	—
VS-E8-M1/4	8	R1/4	29.0	22.5	25.0	47.5	25.0	16	6.0	6.0	17	—	—
VS-E8-M3/8	8	R3/8	30.5	23.0	27.0	51.0	25.0	16	7.5	6.0	22	—	—
VS-E8-M1/2	8	R1/2	30.5	24.0	27.0	50.5	25.0	16	7.5	6.0	22	—	—
VS-E10-M1/4	10	R1/4	29.0	22.5	28.0	50.5	25.0	19	6.0	6.0	17	—	—
VS-E10-M3/8	10	R3/8	30.5	23.0	29.5	52.5	25.0	19	7.5	7.5	22	—	—
VS-E10-M1/2	10	R1/2	30.5	24.0	29.5	53.5	25.0	19	7.5	7.5	22	—	—
VS-E12-M3/8	12	R3/8	30.5	23.0	31.5	54.5	25.0	20	7.5	7.5	22	—	—
VS-E12-M1/2	12	R1/2	30.5	24.0	31.5	55.5	25.0	20	7.5	7.5	22	—	—

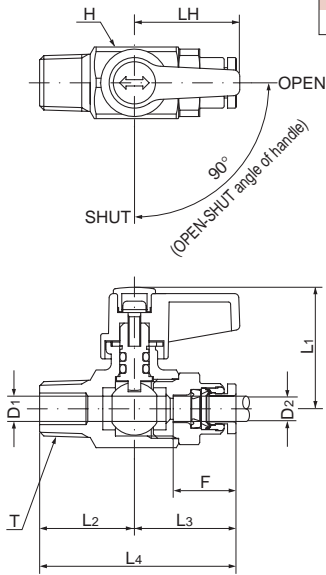

Tube

Clean tube

Processed tube

PushOne fitting

QuickSeal fitting

Clean fitting/ Chemifit

Bamboo-shoot fitting

Control switch/ Detachable series

Jig/Tool/ Accessory

Technical information

Reference

Angled type



●Internal thread

Product number	Applicable tube outer diameter (mm)	T Thread size (Rc)	L ₁ (mm)	L ₂ (mm)	L ₃ (mm)	L ₄ (mm)	LH (mm)	F Tube insertion length (mm)	D ₁ (mm)	D ₂ (mm)	H (mm)	Effective cross-sectional area (mm ²)	Weight (g)
VA-E6-F1/8	6	Rc1/8	24.0	19.0	29.0	48.0	25.0	15	6.0	5.0	17	—	—
VA-E6-F1/4	6	Rc1/4	24.0	21.0	29.0	50.0	25.0	15	6.0	5.0	17	—	—
VA-E8-F1/8	8	Rc1/8	25.0	19.0	29.0	48.0	25.0	16	6.0	6.0	17	—	—
VA-E8-F1/4	8	Rc1/4	25.0	21.0	29.0	50.0	25.0	16	6.0	6.0	17	—	—
VA-E8-F3/8	8	Rc3/8	27.0	24.0	31.0	55.0	25.0	16	7.5	6.0	22	—	—
VA-E10-F1/4	10	Rc1/4	28.0	21.0	29.0	50.0	25.0	19	6.0	6.0	17	—	—
VA-E10-F3/8	10	Rc3/8	30.0	24.0	31.0	55.0	25.0	19	7.5	7.5	22	—	—
VA-E12-F3/8	12	Rc3/8	32.0	24.0	31.0	55.0	25.0	20	7.5	7.5	22	—	—

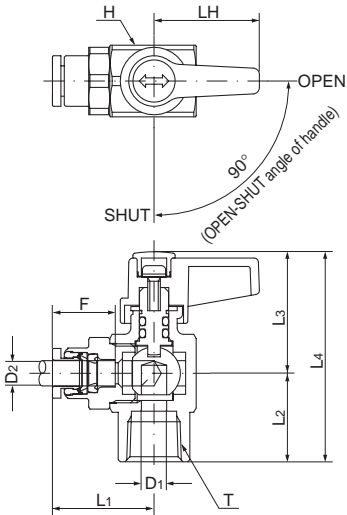

●External thread

Product number	Applicable tube outer diameter (mm)	T Thread size (R)	L ₁ (mm)	L ₂ (mm)	L ₃ (mm)	L ₄ (mm)	LH (mm)	F Tube insertion length (mm)	D ₁ (mm)	D ₂ (mm)	H (mm)	Effective cross-sectional area (mm ²)	Weight (g)
VA-E6-M1/8	6	R1/8	24.0	20.0	29.0	49.0	25.0	15	6.0	5.0	17	—	—
VA-E6-M1/4	6	R1/4	24.0	21.0	29.0	50.0	25.0	15	6.0	5.0	17	—	—
VA-E8-M1/8	8	R1/8	25.0	20.0	29.0	49.0	25.0	16	6.0	6.0	17	—	—
VA-E8-M1/4	8	R1/4	25.0	21.0	29.0	50.0	25.0	16	6.0	6.0	17	—	—
VA-E8-M3/8	8	R3/8	27.0	25.0	31.0	56.0	25.0	16	7.5	6.0	22	—	—
VA-E10-M1/4	10	R1/4	28.0	21.0	29.0	50.0	25.0	19	6.0	6.0	17	—	—
VA-E10-M3/8	10	R3/8	30.0	25.0	31.0	56.0	25.0	19	7.5	7.5	22	—	—
VA-E12-M3/8	12	R3/8	32.0	25.0	31.0	56.0	25.0	20	7.5	7.5	22	—	—
VA-E12-M1/2	12	R1/2	32.0	26.0	31.0	57.0	25.0	20	7.5	7.5	22	—	—

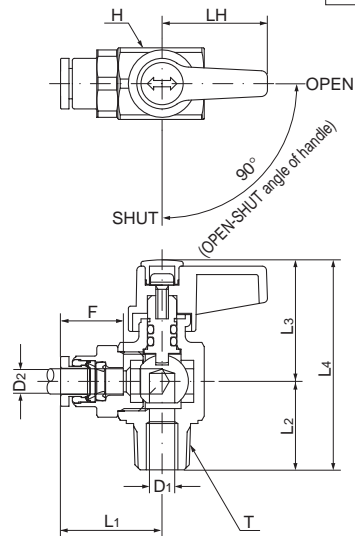

Tube

Clean tube

Processed tube

PushOne fitting

QuickSeal fitting

Clean fitting/ Chemifit

Bamboo-shoot fitting

Control switch/ Detachable series

Jig/Tool/ Accessory

Technical information

Reference

Throttle Valve

PushOne® Type

Features

- Fine control of flow rate
- Flame-resistant resin (compliant V-0 of UL94 standard)
Made of flame-resistant resin PBT. High self-extinguishing performance is compliant with V-0 of UL94 standard. Usable under an environment with spatters.
- Inline type (ESU) allows central control on a pipe line.
Various kinds of piping are possible by fixing with connector pins and brackets.
- PushOne® connection of tube
Jigs and tools are not required for connecting the tubes.
- Electroless nickel plated
Preventing degradation of the surface and dissolution of copper ions into fluid
- Sealing-processed R thread.
Sealing tape is not required.

Cross-sectional structure diagram

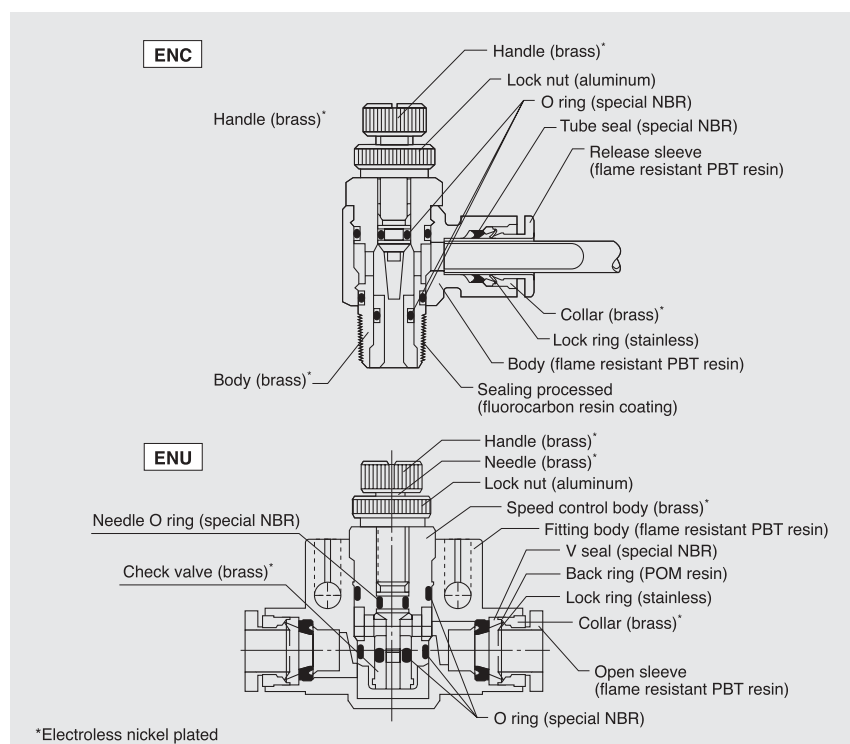

Product number example

ENC 6 - PT1/8 - TR

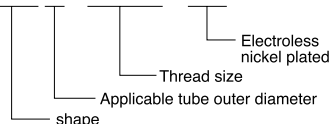

Distinction from speed controller

Color of lock nut

- Throttle valve: bronze color
- Speed controller (Meter-out) : aluminum color
- Speed controller (Meter-in) : bronze color



Operating fluid, working temperature range

Operating fluid	Working temperature range
Air	-20°C~+80°C
Water	0°C~+40°C

Pressure condition

Maximum working pressure: 1.0MPa

Handling instructions

- ⚠ **Caution** When the working conditions of tubes and fittings differ, use them under the lower specified conditions.
- ⚠ **Caution** Tighten the lock nut and handle by hand, not by a spanner.
- ⚠ **Caution** The needle part stops when fully opened. Forced rotation could cause damage.
- ⚠ **Caution** When water is used as the operating fluid, do not allow it to freeze.
- ⚠ **Caution** When water is used as the operating fluid, confirm that there is no water leakage damage to equipment and instruments due to construction failure.
- ⚠ **Caution** Do not bend the pipe sharply near the tube insertion port (sleeve end) of the fitting. Keep the tube straight for twice as long as the tube diameter from the insertion port.

📖 See page142 for the common handling instructions for control, switch and detachable series products.

Inline type connection



Inline type controllers can be connected with a connector pin.
(The photograph shows speed controllers.)

Applicable tube

Polyurethane tube	Nylon tube	Flame-resistant tube	Polyolefine resin tube *1	Fluorocarbon resin tube *1
U2···P.12 U1···P.13 U5···P.14	N2···P.15 N5···P.16 N1···P.17	FS····P.20 FW····P.21 FWU···P.22	PL···P.26 PN···P.27	TA···P.28 TP···P.29

(*1) Combinatory use of PL, PN, TA or TP tube and throttle valve mixes general and clean type performances. When using them in a clean environment, pay attention to the clean level that could be lowered.

Reference

UL-94 standard flame test··········P.204

Elbow type



●Millimeter size type

Product number	Applicable tube outer diameter (mm)	T Thread size (R)	L ₁ (mm)	L ₂ (mm)	L ₃ (mm)	K		A (mm)	F Tube insertion length (mm)	H×φ Width across flat (mm)	N (mm)	M (mm)	D (mm)	Effective cross-sectional area (mm ²)	Weight (g)
						Full open (mm)	Full closed (mm)								
ENC4-PT1/8-TR	4	R1/8	22.1	17.7	29.1	46.8	42.0	9.7	13	13.0×14.0	13.0	10.0	9.7	3.0	29.0
ENC6-PT1/8-TR	6	R1/8	22.2	17.7	29.2	46.8	42.0	9.7	15	13.0×14.0	13.0	10.0	12.5	3.5	30.0

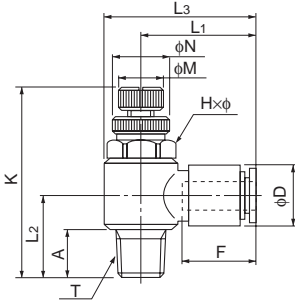

Inline type



●Millimeter size type

Product number	Applicable tube outer diameter (mm)	L (mm)	F Tube insertion length (mm)	K		Effective cross-sectional area (mm ²)	Weight (g)
				Full open (mm)	Full closed (mm)		
ENU4	4	39.2	13	29.5	26.9	—	11.0
ENU6	6	46.4	15	43.5	39.8	—	32.0
ENU8	8	54.0	16	47.7	42.1	—	48.0

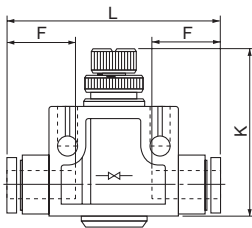

Connector pin

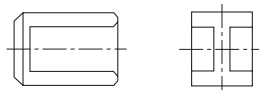

●Connector pin

Product number	Applicable fitting product number
HPN4	ENU4
HPN6	ENU6
	ENU8

Bracket

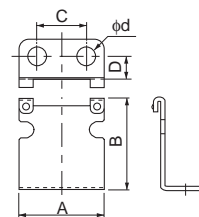

●Bracket

Product number	Applicable fitting product number	A (mm)	B (mm)	C (mm)	D (mm)	d (mm)
BRK4	ENU4	18.0	18.5	10.0	6.5	5.0
BRK6	ENU6	24.0	26.0	14.0	6.5	5.0
BRK8	ENU8	26.0	30.0	14.0	6.5	5.0

Miniature Valve

PushOne® Type and QuickSeal Type

Features

- Easy flow rate control
Easy operation with large handle
- Fine control of flow rate
Fine thread is used for valve system.
- PushOne® connection for millimeter size type
Jigs and tools are not required for connecting the tubes.



Product number example

E MVB 6 - PT1/8

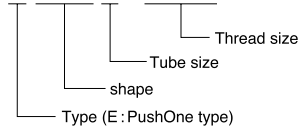

Q MVB 1N 1/4 - R1/8

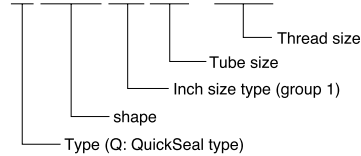

Operating fluid, working temperature range

Operating fluid	Working temperature range
Air	-20°C~+80°C
Water	0°C~+40°C

Pressure condition

Maximum working pressure: 1.0MPa
Negative pressure performance: -98.642kPa



Handling instructions

- ⚠ **Caution** When the working conditions of tubes and fittings differ, use them under the lower specified conditions.
- ⚠ **Caution** When water is used as the operating fluid, do not allow it to freeze.
- ⚠ **Caution** Do not bend the pipe sharply near the tube insertion port (sleeve end) of the fitting. Keep the tube straight for twice as long as the tube diameter from the insertion port.
- ⚠ **Caution** The miniature valve has a determined flow direction, which is indicated on the side body. Flow fluid in the correct direction to control the flow rate.

📖 See page142 for the common handling instructions for control, switch and detachable



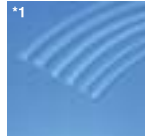

Applicable tube

PushOne type (millimeter size)

Polyurethane tube	Nylon tube	Polyolefine resin tube	Fluorocarbon resin tube
			
U2...P.12 U1...P.13 U5...P.14	N2...P.15 N5...P.16 N1...P.17	PL...P.26 PN...P.27	TA...P.28 TP...P.29

(*1) Combinatory use of PL, PN, TA or TP tube and miniature valve mixes general and clean type performances. When using them in a clean environment, pay attention to the clean level that could be lowered.

QuickSeal type (Inch size)

Polyurethane tube	Nylon tube	Polybutene tube	Polyolefine resin tube	Fluorocarbon resin tube
				
U2...P.12	N2...P.15 N5...P.16 N1...P.17	PB...P.25	PL...P.26	TA...P.28 TP...P.29

(*1) Combinatory use of PL, TA or TP tube and miniature valve mixes general and clean type performances. When using them in a clean environment, pay attention to the clean level that could be lowered.

Reference

Negative-pressure performance list.....P.177

Miniature Valve (PushOne® type)

Inline type

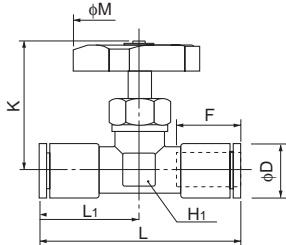

●Millimeter size type

Product number	Applicable tube outer diameter (mm)	L (mm)	L ₁ (mm)	K		M (mm)	F Tube insertion length (mm)	H ₁ Width across flat (mm)	D (mm)	Effective cross-sectional area (mm ²)	Weight (g)
				Full open (mm)	Full closed (mm)						
EMVA6	6	50.6	25.3	39.9	35.9	40.0	15	15.0	15.0	—	—
EMVA8	8	51.6	25.8	39.9	35.9	40.0	16	15.0	15.0	2.5	86.0

Straight type

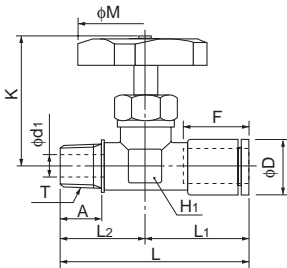

●Millimeter size type

Product number	Applicable tube outer diameter (mm)	T Thread size (R)	L (mm)	L ₁ (mm)	L ₂ (mm)	A (mm)	K		M (mm)	F Tube insertion length (mm)	H ₁ Width across flat (mm)	d ₁ (mm)	D (mm)	Effective cross-sectional area (mm ²)	Weight (g)
							Full open (mm)	Full closed (mm)							
EMVB6-PT1/8	6	R1/8	46.8	25.3	21.5	10.0	39.9	35.9	40.0	15	15.0	5.0	15.0	3.5	81.0
EMVB6-PT1/4	6	R1/4	49.8	25.3	24.5	13.0	39.9	35.9	40.0	15	15.0	7.0	15.0	3.5	84.5
EMVB8-PT1/4	8	R1/4	50.3	25.8	24.5	13.0	39.9	35.9	40.0	16	15.0	7.0	15.0	—	—

Angled type

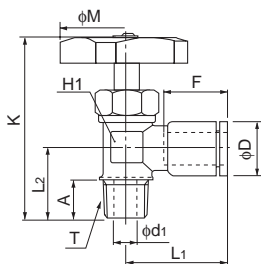

●Millimeter size type

Product number	Applicable tube outer diameter (mm)	T Thread size (R)	L ₁ (mm)	L ₂ (mm)	A (mm)	K		M (mm)	F Tube insertion length (mm)	H ₁ Width across flat (mm)	d ₁ (mm)	D (mm)	Effective cross-sectional area (mm ²)	Weight (g)
						Full open (mm)	Full closed (mm)							
EMVC6-PT1/8	6	R1/8	25.3	23.0	12.0	57.9	53.9	40.0	15	15.0	5.0	15.0	7.0	76.5
EMVC6-PT1/4	6	R1/4	25.3	23.0	12.0	57.9	53.9	40.0	15	15.0	7.0	15.0	—	—
EMVC8-PT1/4	8	R1/4	24.8	23.0	12.0	57.9	53.9	40.0	16	15.0	7.0	15.0	7.0	78.0

Tube

Clean tube

Processed tube

PushOne fitting

QuickSeal fitting

Clean fitting/ Chemfit

Bamboo-shoot fitting

Control switch/ Detachable series

Jig/Tool/ Accessory

Technical information

Reference

Miniature Valve (QuickSeal type)

Inline type

●Inch size type



Product number	Applicable tube outer diameter (inch)	L (mm)	L ₁ (mm)	K		M (mm)	S (mm)	F Tube insertion length (mm)	H ₁ Width across flat (mm)	H ₂ (mm)	d ₂ (mm)	Effective cross-sectional area (mm ²)	Weight (g)
				Full open (mm)	Full closed (mm)								
QMVA1N1/4	1/4	54.2	27.1	37.4	33.4	φ40.0	4.6	15	14.0	12.0	3.4	5.0	80.0
QMVA1N3/8	3/8	62.6	31.3	38.9	34.9	φ40.0	4.6	17	17.0	17.0	5.7	6.0	117.0

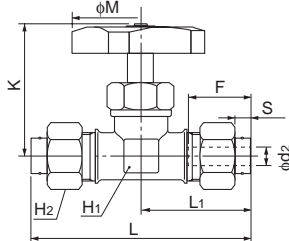

Straight type

●Inch size type



Product number	Applicable tube outer diameter (inch)	T Thread size (R)	L (mm)	L ₁ (mm)	L ₂ (mm)	A (mm)	K		M (mm)	S (mm)	F Tube insertion length (mm)	H ₁ Width across flat (mm)	H ₂ (mm)	d ₁ (mm)	d ₂ (mm)	Effective cross-sectional area (mm ²)	Weight (g)
							Full open (mm)	Full closed (mm)									
QMVB1N1/4-R1/8	1/4	R1/8	46.6	27.1	19.5	10.0	37.4	33.4	φ40.0	4.6	15	14.0	12.0	5.0	3.4	5.0	76.0
QMVB1N1/4-R1/4	1/4	R1/4	48.6	27.1	21.5	12.0	37.4	33.4	φ40.0	4.6	15	14.0	12.0	7.0	3.4	5.5	95.0
QMVB1N3/8-R1/4	3/8	R1/4	56.3	31.3	25.0	12.0	38.9	34.9	φ40.0	4.6	17	17.0	17.0	7.0	5.7	6.0	113.0

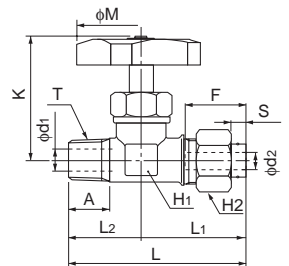

Angled type

●Inch size type



Product number	Applicable tube outer diameter (inch)	T Thread size (R)	L ₁ (mm)	L ₂ (mm)	A (mm)	K		M (mm)	S (mm)	F Tube insertion length (mm)	H ₁ Width across flat (mm)	H ₂ (mm)	d ₁ (mm)	d ₂ (mm)	Effective cross-sectional area (mm ²)	Weight (g)
						Full open (mm)	Full closed (mm)									
QMVC1N1/4-R1/8	1/4	R1/8	27.1	20.0	10.0	54.9	50.9	φ40.0	4.6	15	14.0	12.0	5.0	3.4	—	75.0
QMVC1N1/4-R1/4	1/4	R1/4	27.1	22.0	12.0	56.9	50.9	φ40.0	4.6	15	14.0	12.0	7.0	3.4	7.0	92.0
QMVC1N3/8-R1/4	3/8	R1/4	28.3	23.0	12.0	59.9	55.9	φ40.0	4.6	17	17.0	17.0	7.0	5.7	7.0	104.0

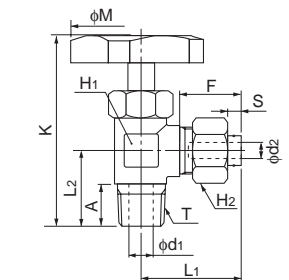

Tube

Clean tube

Processed tube

PushOne fitting

QuickSeal fitting

Clean fitting/ Chemifit

Bamboo-shoot fitting

Control switch/ Detachable series

Jig/Tool/ Accessory

Technical information

Reference

Valve Built-in Connector

PushOne® Type

Features

- Valve inside fitting is opened/closed by attaching/detaching tube
The valve is automatically closed by detaching the tube.
- PushOne® connection of tube
Jigs and tools are not required for connecting the tubes.
- Electroless nickel plated
Preventing degradation of surface and dissolution of copper ions into fluid
- Sealing-processed R thread.
Sealing tape is not required.



Cross-sectional structure diagram

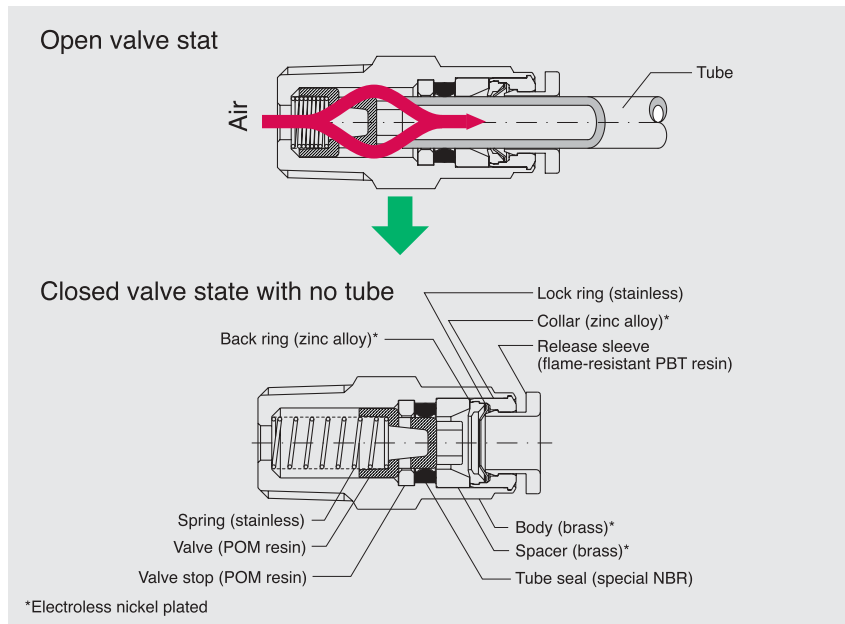

Operating fluid, working temperature range

Operating fluid	Working temperature range
Air	+20°C~+60°C

Pressure condition

Maximum working pressure: 1.0MPa

Handling instructions

- ⚠ **Caution** When the working conditions of tubes and fittings differ, use them under the lower specified conditions.
 - ⚠ **Caution** Cannot be used at a negative pressure.
 - ⚠ **Caution** Detach tube when it is unpressurized.
 - ⚠ **Caution** Do not bend the pipe sharply near the tube insertion port (sleeve end) of the fitting. Keep the tube straight for twice as long as the tube diameter from the insertion port.
- 👉 See page142 for the common handling instructions for control, switch and detachable series products.

Applicable tube

Polyurethane tube	Nylon tube	Flame-resistant tube	Polyolefine resin tube	Fluorocarbon resin tube
U2...P.12 U1...P.13 U5...P.14	N2...P.15 N5...P.16 N1...P.17	FS...P.20 FW...P.21 FWU...P.22	PL...P.26 PN...P.27	TA...P.28 TP...P.29

(*1) Combinatory use of PL, PN, TA or TP tube and valve built-in connector mixes general and clean type performances.
When using them in a clean environment, pay attention to the clean level that could be lowered.

Connector

●Millimeter size type



Product number	Applicable tube outer diameter (mm)	T Thread size (M,R)	L (mm)	A (mm)	F Tube insertion length (mm)	H×φ Width across flat (mm)	D (mm)	d ₁ (mm)	Effective cross-sectional area (mm ²)	Weight (g)
ECV4-M5	4	M5×0.8	32.6	4.0	16	10.0×11.0	10.0	2.0	2.0	11.0
ECV6-PT1/8	6	R1/8	40.4	8.0	17	14.0×15.4	13.0	4.0	6.5	26.0
ECV6-PT1/4	6	R1/4	31.4	11.0	17	14.0×15.4	13.0	4.0	6.5	21.0

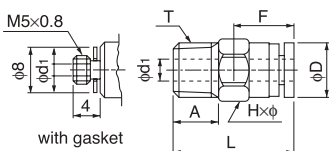

Q.D.C. 101 Series

Compact coupler for air pressure

Features

- **Push-To-Connect type**
One-touch connection just to push the nipple into the coupler.
- **Automatic opening/closing valve inside the coupler**
The valve inside the coupler is automatically opened by connecting the coupler and the nipple.
- SUS304 type (made to order) available
- PushOne® fitting integrated types available



Cross-sectional structure diagram

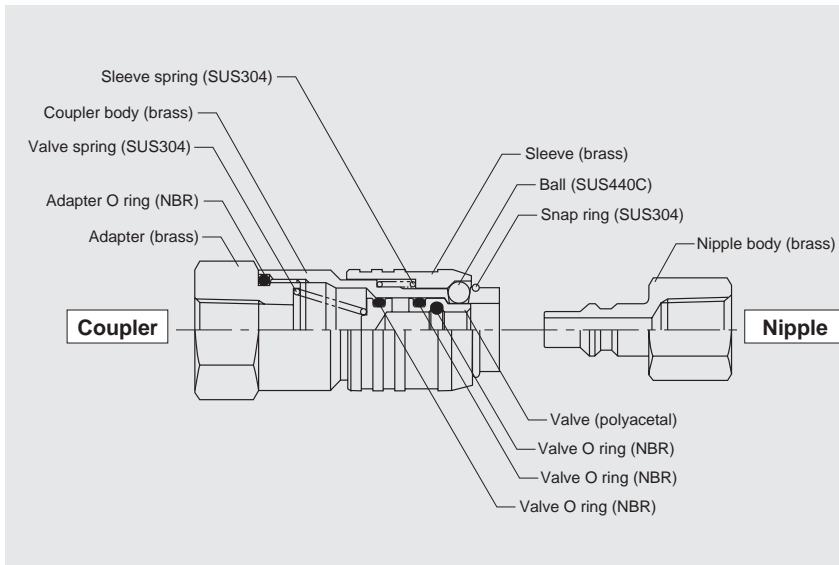

Operating fluid, working temperature range

Operating fluid	Working temperature range
Air	-20°C~+80°C

Pressure condition

Maximum working pressure: 1.0MPa
Negative pressure performance: -99.975kPa

Handling instructions

- ⚠ **Caution** When the working conditions of tubes and fittings are different, use them under the lower specified conditions.
 - ⚠ **Caution** Neither the coupler nor nipple can be connected to other manufacturers' products.
 - ⚠ **Caution** Detach the tube, coupler or nipple in an unpressurized state.
 - ⚠ **Caution** Do not use and rotate the coupler as a substitute for a rotary joint or swivel joint.
 - ⚠ **Caution** Do not use the coupler or nipple in a place contaminated with metal particles or dust. It could cause problems with operation.
 - ⚠ **Caution** Connection and disconnection under a residual pressure may cause an accident. Also, do not hit the front end with a hammer to release pressure.
 - ⚠ **Caution** In case of leakage due to abrasion or degradation of O ring, replace the O ring as well as the body with a new one.
- 📖 See page142 for the common handling instructions for control, switch and detachable series products.

Product number example

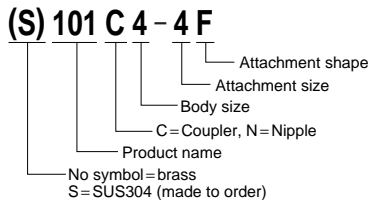

Tube
Clean tube
Processed tube
PushOne fitting
QuickSeal fitting
Clean fitting/Chemifit
Bamboo-shoot fitting
Control switch/Detachable series
Jig/Tool/Accessory
Technical information
Reference

Coupler

PushOne® type

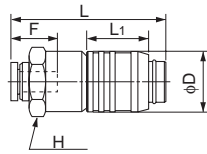

Product number	Applicable tube outer diameter (mm)	L (mm)	L ₁ (mm)	F Tube insertion length (mm)	H Width across flat (mm)	D (mm)	Weight (g)
101C4-6E	6	49.3	19.5	15	19.0	19.0	62.0
101C4-8E	8	49.8	19.5	16	19.0	19.0	62.0
101C4-10E	10	53.3	19.5	19	19.0	19.0	64.5

Internal thread type

Brass type



Stainless type

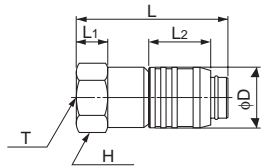

Product number	T Thread size (Rc)	L (mm)	L ₁ (mm)	L ₂ (mm)	H Width across flat (mm)	D (mm)	Weight (g)
101C4-2F	Rc1/8	48.0	10.0	19.5	19.0	19.0	67.5
101C4-4F	Rc1/4	48.0	10.0	19.5	19.0	19.0	60.5
S101C4-2F	Rc1/8	48.0	10.0	19.5	19.0	19.0	67.5
S101C4-4F	Rc1/4	48.0	10.0	19.5	19.0	19.0	60.5

*Made to order

External thread type

Brass type



Stainless type

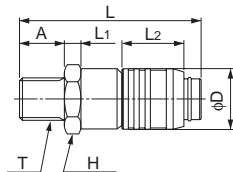

Product number	T Thread size (R)	L (mm)	A (mm)	L ₁ (mm)	L ₂ (mm)	H Width across flat (mm)	D (mm)	Weight (g)
101C4-2M	R1/8	53.5	10.0	5.5	19.5	19.0	19.0	59.0
101C4-4M	R1/4	57.5	14.0	5.5	19.5	19.0	19.0	64.0
S101C4-2M	R1/8	53.5	10.0	5.5	19.5	19.0	19.0	59.0
S101C4-4M	R1/4	57.5	14.0	5.5	19.5	19.0	19.0	64.0

*Made to order

N2-1-1/4 type

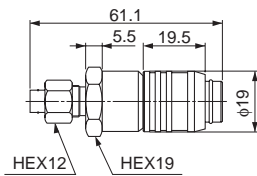

Nylon coil tube S1/4 type

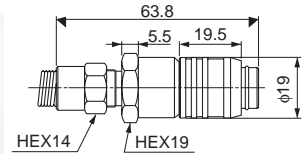

$\phi 8$ hose type

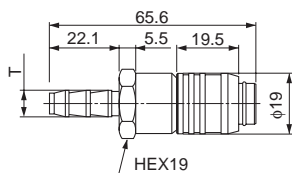

Tube

Clean tube

Processed tube

PushOne fitting

QuickSeal fitting

Clean fitting/Chemifit

Bamboo-shoot fitting

Control switch/Detachable series

Jig/Tool/Accessory

Technical information

Reference

Nipple

PushOne® type

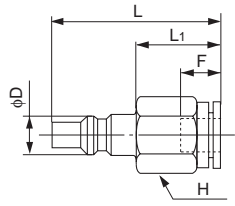

Product number	Applicable tube outer diameter (mm)	L (mm)	L1 (mm)	F Tube insertion length (mm)	H Width across flat (mm)	D (mm)	Weight (g)
101N4-6E	6	33.0	16.5	15	12.0	8.3	13.0
101N4-8E	8	34.5	18.0	16	14.0	8.3	16.0
101N4-10E	10	38.0	21.5	17	17.0	8.3	27.0

Internal thread type

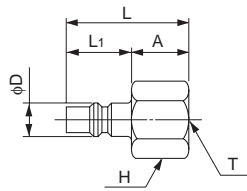

Product number	T Thread size (Rc)	L (mm)	L1 (mm)	A (mm)	H Width across flat (mm)	D (mm)	Weight (g)
101N4-2F	Rc1/8	29.5	16.6	12.9	14.0	8.3	16.5
101N4-4F	Rc1/4	32.8	16.6	16.2	14.0	8.3	25.0
* S101N4-2F	Rc1/8	29.5	16.6	12.9	14.0	8.3	16.5
* S101N4-4F	Rc1/4	32.8	16.6	16.2	14.0	8.3	25.0

*Made to order

External thread type

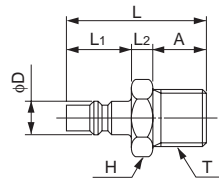

Product number	T Thread size (R)	L (mm)	L1 (mm)	L2 (mm)	A (mm)	H Width across flat (mm)	D (mm)	Weight (g)
101N4-2M	R1/8	31.4	16.6	4.8	10.0	14.0	8.3	13.5
101N4-4M	R1/4	35.4	16.6	4.8	14.0	14.0	8.3	18.0
* S101N4-2M	R1/8	31.4	16.6	4.8	10.0	14.0	8.3	13.5
* S101N4-4M	R1/4	35.4	16.6	4.8	14.0	14.0	8.3	18.0

*Made to order

N2-1-1/4 type

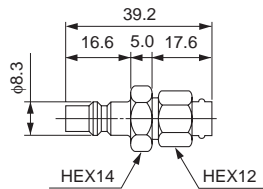

Nylon coil tube S1/4 type

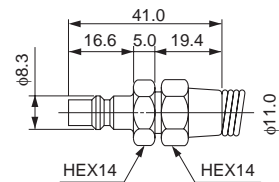

φ8 hose type

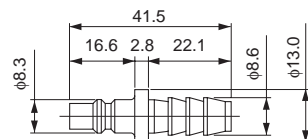

Q.D.C. 103 Series

Micro size coupler for air and oil pressure

Features

- **Push-To-Connect type**
One-touch connection just to push the nipple into the coupler.
- **Automatic opening/closing valve inside the coupler**
The valve inside the coupler is automatically opened by connecting the coupler and the nipple.
- **Smaller than 101 series**
Bamboo-shoot fitting integrated type available for direct connection to U5 tube
- **Electroless nickel plated**
Preventing degradation of surface and dissolution of copper ions into fluid

Cross-sectional structure diagram

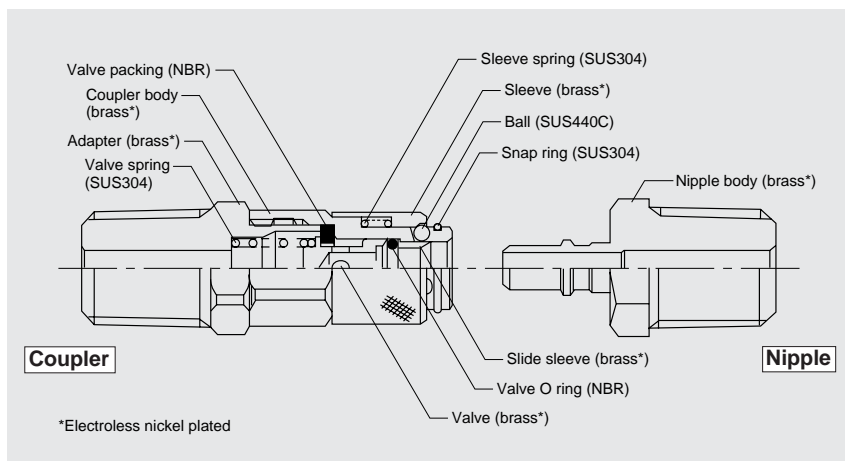

Operating fluid, working temperature range

Operating fluid	Working temperature range
Air	-20°C~+80°C
Water	0°C~+80°C
General operating oil	-20°C~+80°C

Pressure condition

Maximum working pressure: 1.0MPa
Negative pressure performance:
-99.975kPa

Handling instructions

- ⚠ **Caution** When working conditions of tubes and fittings are different, use them under the lower specified conditions.
 - ⚠ **Caution** Neither the coupler nor nipple can be connected to other manufacturers' products.
 - ⚠ **Caution** Detach the tube, coupler or nipple in an unpressurized state.
 - ⚠ **Caution** Do not use and rotate coupler as a substitute for rotary joint or swivel joint.
 - ⚠ **Caution** When water is used as the operating fluid, do not allow it to freeze.
 - ⚠ **Caution** Do not use the coupler or nipple in a place contaminated with metal particles or dust. It could cause problems with operation.
 - ⚠ **Caution** Connection and disconnection under residual pressure may cause an accident. Also, do not hit the front end with a hammer to release pressure.
 - ⚠ **Caution** In case of leakage due to abrasion or degradation of the O ring, replace the O ring as well as the body with a new one.
- 👉 See page142 for the common handling instructions for the control, switch and detachable series products.

Product number example

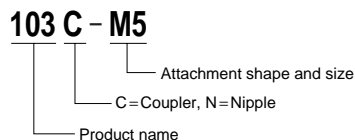

Coupler

Connector type

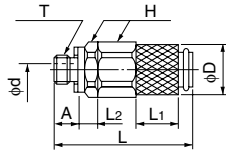

Product number	T Thread size (M)	L (mm)	L ₁ (mm)	L ₂ (mm)	A (mm)	H Width across flat (mm)	D (mm)	d (mm)	Weight (g)
103C-M5	M5×0.8	25.0	8.0	2.5	4.0	9.0	9.5	2.5	8.0

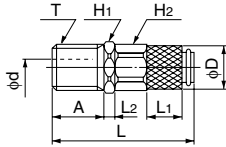

Product number	T Thread size (R)	L (mm)	L ₁ (mm)	L ₂ (mm)	A (mm)	H ₁ Width across flat (mm)	H ₂ Width across flat (mm)	D (mm)	d (mm)	Weight (g)
103C-2M	R1/8	31.0	8.0	3.0	11.0	10.0	9.0	9.5	3.0	13.0

Elbow type

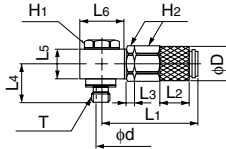

Product number	T Thread size (M)	L ₁ (mm)	L ₂ (mm)	L ₃ (mm)	L ₄ (mm)	L ₅ (mm)	L ₆ (mm)	H ₁ Width across flat (mm)	H ₂ Width across flat (mm)	D (mm)	d (mm)	Weight (g)
103C-M5UL	M5×0.8	25.9	8.0	2.5	10.1	8.0	12.0	8.0	9.0	9.5	2.0	15.0

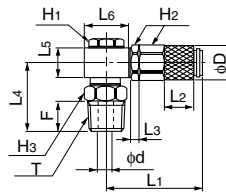

Product number	T Thread size (R)	L ₁ (mm)	L ₂ (mm)	L ₃ (mm)	L ₄ (mm)	L ₅ (mm)	L ₆ (mm)	F (mm)	H ₁ Width across flat (mm)	H ₂ Width across flat (mm)	H ₃ Width across flat (mm)	D (mm)	d (mm)	Weight (g)
103C-2MUL	R1/8	25.9	8.0	2.5	18.9	8.0	12.0	8.5	8.0	9.0	10.0	9.5	4.2	21.0

U5-tube dedicated barb type

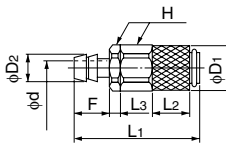

Product number	Applicable tube type	L ₁ (mm)	L ₂ (mm)	L ₃ (mm)	F (mm)	H Width across flat (mm)	D ₁ (mm)	D ₂ (mm)	d (mm)	Weight (g)
103C-25H	U5-4×2.5	26.0	8.0	2.5	6.5	9.0	9.5	3.5	1.5	7.5
103C-40H	U5-4×4	27.5	8.0	2.5	8.0	9.0	9.5	5.7	3.0	8.0

U5-tube dedicated barb elbow type

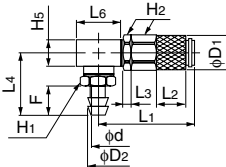

Product number	Applicable tube type	L ₁ (mm)	L ₂ (mm)	L ₃ (mm)	L ₄ (mm)	L ₅ (mm)	L ₆ (mm)	F (mm)	H ₁ Width across flat (mm)	H ₂ Width across flat (mm)	D ₁ (mm)	D ₂ (mm)	d (mm)	Weight (g)
103C-25HL	U5-4×2.5	25.9	8.0	2.5	15.9	8.0	12.0	6.5	8.0	9.0	9.5	3.5	1.5	15.0
103C-40HL	U5-4×4	25.9	8.0	2.5	17.4	8.0	12.0	6.5	8.0	9.0	9.5	5.7	3.0	15.5

Tube
Clean tube
Processed tube
PushOne fitting
QuickSeal fitting
Clean fitting/Chemifit
Bamboo-shoot fitting
Control switch/Detachable series
Jig/Tool/Accessory
Technical information
Reference

Nipple

Connector type

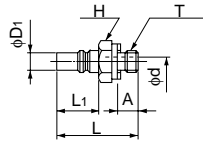

Product number	T Thread size (M)	L (mm)	L ₁ (mm)	A (mm)	H Width across flat (mm)	D ₁ (mm)	d (mm)	Weight (g)
103N-M5	M5×0.8	17.5	9.0	4.0	8.0	3.5	2.5	2.5

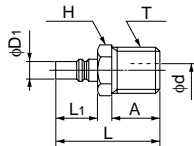

Product number	T Thread size (R)	L (mm)	L ₁ (mm)	A (mm)	H Width across flat (mm)	D ₁ (mm)	d (mm)	Weight (g)
103N-2M	R1/8	23.0	9.0	11.0	10.0	3.5	3.0	8.0

Elbow type

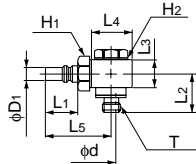

Product number	T Thread size (M)	L ₁ (mm)	L ₂ (mm)	L ₃ (mm)	L ₄ (mm)	L ₅ (mm)	H ₁ Width across flat (mm)	H ₂ Width across flat (mm)	D ₁ (mm)	d (mm)	Weight (g)
103N-M5UL	M5×0.8	9.0	10.1	8.0	12.0	18.4	8.0	8.0	3.5	2.0	9.5

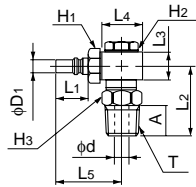

Product number	T Thread size (R)	L ₁ (mm)	L ₂ (mm)	L ₃ (mm)	L ₄ (mm)	L ₅ (mm)	A (mm)	H ₁ Width across flat (mm)	H ₂ Width across flat (mm)	H ₃ Width across flat (mm)	D ₁ (mm)	d (mm)	Weight (g)
103N-2MUL	R1/8	9.0	18.9	8.0	12.0	18.4	8.5	8.0	8.0	10.0	3.5	4.2	15.5

U5-tube dedicated barb type

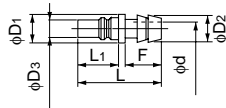

Product number	Applicable tube type	L (mm)	L ₁ (mm)	F (mm)	D ₁ (mm)	D ₂ (mm)	D ₃ (mm)	d (mm)	Weight (g)
103N-25H	U5-4-4×2.5	17.0	9.0	6.5	6.0	3.5	3.5	1.5	1.0
103N-40H	U5-4-6×4	18.5	9.0	8.0	6.0	5.7	3.5	3.0	1.5

U5-tube dedicated barb elbow type

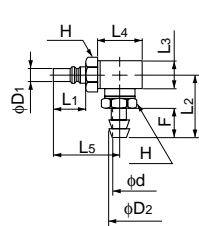

Product number	Applicable tube type	L ₁ (mm)	L ₂ (mm)	L ₃ (mm)	L ₄ (mm)	L ₅ (mm)	F (mm)	H Width across flat (mm)	D ₁ (mm)	D ₂ (mm)	d (mm)	Weight (g)
103N-25HL	U5-4-4×2.5	9.0	15.9	8.0	12.0	18.4	6.5	8.0	3.5	3.5	1.5	9.5
103N-40HL	U5-4-6×4	9.0	17.4	8.0	12.0	18.4	8.0	8.0	3.5	5.7	3.0	10.0

Tube

Clean tube

Processed tube

PushOne fitting

QuickSeal fitting

Clean fitting/ Chemifit

Bamboo-shoot fitting

Control switch/ Detachable series

Jig/Tool/ Accessory

Technical information

Reference

Jigs, Tools and Accessories

INDEX

Tube cutter



Hose cutter



FW tube outer cover peeling cutter



FWU tube outer cover peeling cutter



Spatter cap For protection of the PushOne connection part from spatter, etc.



Tube removing jig (Off tool)



Tube reel



Tube

Clean tube

Processed tube

PushOne fitting

QuickSeal fitting

Clean fitting/Chemifit

Bamboo-shoot fitting

Control switch/Detachable series

Jig/Tool/Accessory

Technical information

Reference

Tube cutter

TC04



Features

- Compact, handy-to-carry, light weight tube cutter
- Only the blade needs changing. It comes with three spare blades.
- Tubes up to 13mm diameter can be cut.

Applicable tube size

Tube outer diameter : ~13mm (1/2inch)

Handling instructions

- ⚠ **Warning** Do not touch the cutter blade. It is sharp and may cut your fingers.
- ⚠ **Caution** TC04 is developed for cutting resin tubes only. Do not use it for other purposes.
- ⚠ **Caution** Do not put it in your pocket, etc. It may cause an accident if the blade is open.

TC01



Features

- Highly durable nipper-type tube cutter
- Tubes up to 13mm diameter can be cut.

Applicable tube size

Tube outer diameter : ~13mm (1/2inch)

Handling instructions

- ⚠ **Warning** Do not touch the cutter blade. It is sharp and may cut your fingers.
- ⚠ **Caution** TC01 is developed for cutting resin tubes. Do not use it for other purposes.

Hose cutter

HC03



Features

- Highly durable nipper-type tube cutter
- Tubes up to 20mm diameter can be cut.

Applicable tube size

Tube outer diameter : ~20mm (3/4inch)

📖 Use hose cutter HC01 to cut a tube of size 20-40mm.

Handling instructions

- ⚠ **Warning** Do not touch the cutter blade. It is sharp and may cut your fingers.
- ⚠ **Caution** HC03 is developed for cutting resin tubes. Do not use it for other purposes.

Tube

Clean tube

Processed tube

PushOne fitting

QuickSeal fitting

Clean fitting/Chemifit

Bamboo-shoot fitting

Control switch/Detachable series

Jig/Tool/Accessory

Technical information

Reference

FW tube outer cover peeling cutter

TC02 • TC03



Features

- Easy peeling of FW tube outer cover

Applicable tube size

Product number	Applicable tube type
TC02	FW-4-6×4, FW-4-8×5
TC03	FW-4-10×7.5, FW-4-12×9

Handling instructions

- ⚠ **Warning** Do not touch the cutter blade. It is sharp and may cut your fingers.
- ⚠ **Caution** It is developed only for peeling the outer cover of FW tubes. Do not use it for other purposes because it may cause an accident.

Reference

- Instruction manual.....P.193

FWU tube outer cover peeling cutter

TC02U • TC03U



Features

- Easy peeling of FWU tube outer cover

Applicable tube size

Product number	Applicable tube type
TC02U	FWU-4-6×4, FWU-4-8×5
TC03U	FWU-4-10×6.5, FWU-4-12×8

Handling instructions

- ⚠ **Warning** Do not touch the cutter blade. It is sharp and may cut your fingers.
- ⚠ **Caution** It is developed only for peeling the outer cover of FWU tubes. Do not use it for other purposes because it may cause an accident.

Reference

- Instruction manual.....P.193

Tube

Clean tube

Processed tube

PushOne fitting

QuickSeal fitting

Clean fitting/Chemifit

Bamboo-shoot fitting

Control switch/Detachable series

Jig/Tool/Accessory

Technical information

Reference

Spatter cap

CP • CPFW



CPP (Attachable after piping)



Features

- Protecting PushOne connecting part from spatter, etc
- CCP can be attached after connecting tube.

Specification

Specification	Product number	Applicable tube outer diameter(mm)	Applicable tube type
Attachment before tube piping	CP4	4	FS
	CP6	6	
	CP8	8	
	CP10	10	
	CP12	12	
Attachment after tube piping	CPFW6	6	FW*FWU
	CPFW8	8	
	CPFW10	10	
	CPFW12	12	
Attachment after tube piping	CPP6	6	FS*FW*FWU
	CPP8	8	
	CPP10	10	
	CPP12	12	

Reference

- Instruction manual.....P.196

Tube removing jig (Off tool)

EOT 6-4



Features

- Helps removing tube from PushOne

Applicable tube size

Tube outer diameter : φ4, φ6

Reference

- Instruction manual.....P.197

Tube reel

PTR

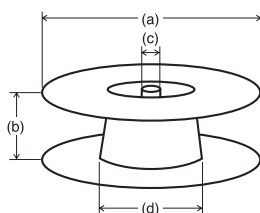

Features

- Easy handling
- Recycled polypropylene resin used

Specification

Product number	Applicable tube size	Size (mm)				Weight(g)
		(a) Collar width	(b) Reel width	(c) Shaft width	(d) Reel body diameter	
PTR-1	Millimeter size: φ4, 6, 8	(a)	(b)	(c)	(d)	1030
	Inch size : φ1/8, 1/4, 5/16	480	105	50	225	
PTR-2	Millimeter size: φ10, 12	(a)	(b)	(c)	(d)	1170
	Inch size : φ3/8, 1/2	480	210	50	225	

Use PTR-2 for φ8-size FW and FWU tube of 100m long.

Handling instructions

- ⚠ **Caution** The tube reel cannot be used with other manufacturers' tubes.
- ⚠ **Caution** The tube reel is made of resin and may be cracked if dropped or hit hard. Careful handling is required.
- ⚠ **Caution** You may need to widen the inner drum to set a tube if the wound tube bundle is deformed.

Reference

- Instruction manual.....P.194

Tube

Clean tube

Processed tube

PushOne fitting

QuickSeal fitting

Clean fitting/Chemifit

Bamboo-shoot fitting

Control switch/Detachable series

Jig/Tool/Accessory

Technical information

Reference

Technical Information

INDEX

Speed controller flow rate characteristics

Compact speed controller	P.171
Chemifit C1 speed controller	P.173
Speed controller	P.175

Effective cross-sectional area	P.176
--------------------------------	-------

Negative pressure performance list	P.177
------------------------------------	-------

Instruction Manual

PushOne series	P.178
QuickSeal series	P.180
Chemifit C1 series	P.182
Chemifit C1S series	P.184
Chemifit CSA series	P.186
Chemifit CS series	P.188
Chemifit CP series	P.190
Q.D.C 101 series	P.192
Q.D.C 103 series	P.192
FW/FWU tube outer cover peeling cutter	P.193
Tube reel	P.194
Spatter Cap	P.196
Off tool	P.197

Speed controller flow rate characteristics

Compact speed controller (elbow type)

Product number	Controlled flow	Free flow
ASC4-M5-★ ASC6-M5-★		
ASC4-R1/8-★		
ASC6-R1/8-★ ASC8-R1/8-★ ASC10-R1/8-★		
ASC6-R1/4-★		
ASC8-R1/4-★ ASC10-R1/4-★		

“★” is either \bar{O} (meter-out) or I (meter-in).

Tube

Clean tube

Processed tube

PushOne fitting

QuickSeal fitting

Clean fitting/ Chemifit

Bamboo-shoot fitting

Control switch/ Detachable series

Jig/Tool/ Accessory

Technical information

Reference

Compact speed controller (elbow type)

Product number	Controlled flow	Free flow
ASC8-R3/8-★		
ASC10-R3/8-★ ASC12-R3/8-★		
ASC10-R1/2-★		
ASC12-R1/2-★		

“★” is either \bar{O} (meter-out) or I (meter-in).

Tube

Clean tube

Processed tube

PushOne fitting

QuickSeal fitting

Clean fitting/ Chemifit

Bamboo-shoot fitting

Control switch/ Detachable series

Jig/Tool/ Accessory

Technical information

Reference

Chemifit® C1 speed controller (elbow type)

Product number	Controlled flow	Free flow
ESC4-R1/8-O-C1SG ESC6-R1/8-O-C1SG ESC8-R1/8-O-C1SG		
ESC6-R1/4-O-C1SG ESC8-R1/4-O-C1SG ESC10-R1/4-O-C1SG		
ESC8-R3/8-O-C1SG ESC10-R3/8-O-C1SG ESC12-R3/8-O-C1SG		

Tube

Clean tube

Processed tube

PushOne fitting

QuickSeal fitting

Clean fitting/Chemifit

Bamboo-shoot fitting

Control switch/Detachable series

Jig/Tool/Accessory

Technical information

Reference

Chemifit® C1 speed controller (inline type)

Product number	Controlled flow	Free flow
ESU4-C1SG	<p>Flow rate $\ell/\text{min. (ANR)}$ vs. Number of needle rotations (times)</p>	<p>Flow rate $\ell/\text{min. (ANR)}$ vs. Pressure (MPa)</p>
ESU6-C1SG	<p>Flow rate $\ell/\text{min. (ANR)}$ vs. Number of needle rotations (times)</p>	<p>Flow rate $\ell/\text{min. (ANR)}$ vs. Pressure (MPa)</p>
ESU8-C1SG	<p>Flow rate $\ell/\text{min. (ANR)}$ vs. Number of needle rotations (times)</p>	<p>Flow rate $\ell/\text{min. (ANR)}$ vs. Pressure (MPa)</p>

Tube

Clean tube

Processed tube

PushOne fitting

QuickSeal fitting

Clean fitting/ Chemifit

Bamboo-shoot fitting

Control switch/ Detachable series

Jig/Tool/ Accessory

Technical information

Reference

Speed controller (inline type)

Product number	Controlled flow	Free flow
ESU4		
ESU6		
ESU8		

Tube

Clean tube

Processed tube

PushOne fitting

QuickSeal fitting

Clean fitting/Chemifit

Bamboo-shoot fitting

Control switch/Detachable series

Jig/Tool/Accessory

Technical information

Reference

Effective Cross-sectional Area

1 Effective cross-sectional area of fitting

Measurement method (JIS B 8381-1995 compliant)

Attach a switching valve to a container of inner volume V, and attach a sample fitting (*) to the outlet of the switching valve. Fill 0.5MPa air in the container. Open the valve to release air for time t until the air pressure inside the container decreases to 0.2MPa. Wait until the inside pressure is stabilized. Measure the residual pressure and calculate the effective cross-sectional area using the following equation.

(*) Connect a tube listed in Table 1 to the fitting and cut the tube at the fitting end.

$$S = \left(12.9V \times \frac{1}{t} \log_{10} \frac{P_0 + 0.101}{P + 0.101} \right) \sqrt{\frac{273}{T + 273}}$$

- S : Effective cross-sectional area (mm²)
- V : Inner volume of container (λ)
- P₀ : Initial pressure inside container (MPa)
- P : Residual pressure (MPa)
- t : Release time (s)
- T : Room temperature (°C)

[Table 1] Test tube size list

Test fitting	Fitting size	Tube size
	3	3×1.8
	4	4×2.5
PushOne A series	6	6×4
PushOne E series	8	8×6
QuickSeal series Insertless type	10	10×7.5
Chemifit C1 series	12	12×9
Chemifit C1S series	16	16×13
Chemifit CP series	1/4	6.35×4.57
	5/16	7.94×5.90
	3/8	9.53×6.99
	1/2	12.7×9.56

(*) For QuickSeal series (insertion type, DK tube dedicated type, nylon coil tube dedicated type), bamboo-shoot fitting series (barb type), Chemifit CSA series and Chemifit CS series, use applicable tube size.

2 Effective cross-sectional area of tube

Relation of tube length and effective cross-sectional area (mm²) for various tube inner diameters (mm)

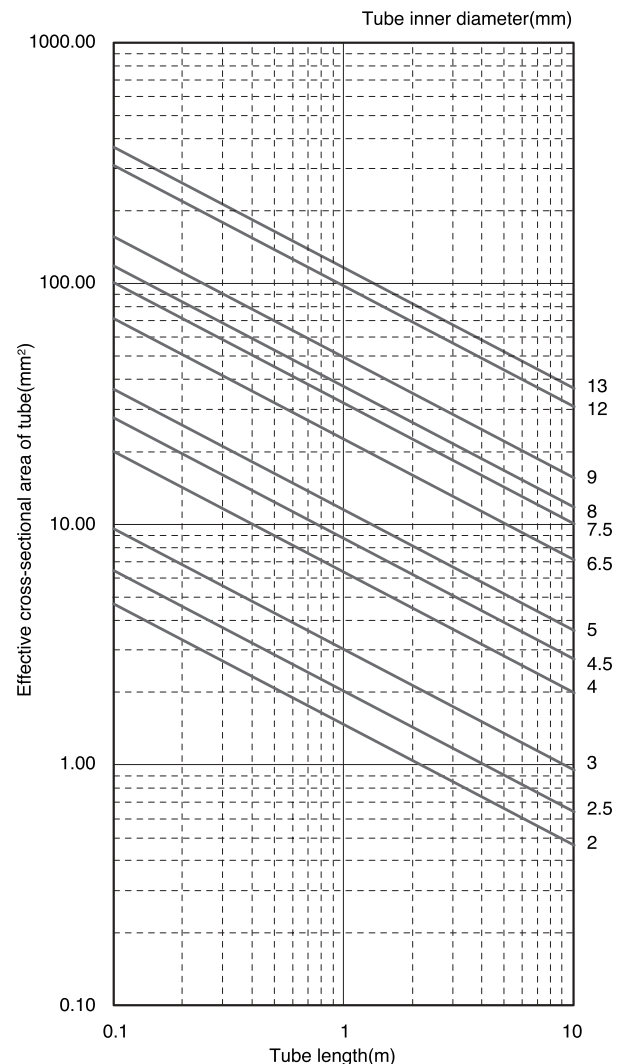

3 Calculation of combined effective cross-sectional area

(1) Series connection

$$\frac{1}{S^2} = \sum_{i=1}^n \left(\frac{1}{S_i^2} \right) = \frac{1}{S_1^2} + \frac{1}{S_2^2} + \dots + \frac{1}{S_n^2}$$

- S : Combined effective cross-sectional area (mm²)
- S_i : S₁ ... S_n: Effective cross-sectional area of each element (mm²)

(2) Parallel connection

$$S = \sum_{i=1}^n (S_i) = S_1 + S_2 + \dots + S_n$$

- S : Combined effective cross-sectional area (mm²)
- S_i : S₁ ... S_n: Effective cross-sectional area of each element (mm²)

4 Air consumption

(1) Sound speed flow

$$\frac{P_1 + 0.1013}{P_2 + 0.1013} \geq 1.89$$

$$Q = 113 \times S \times (P_1 + 0.1013)$$

- Q : Air flow rate (ℓ/min. atmospheric pressure basis)
- P₁ : Primary pressure (MPa)
- P₂ : Secondary pressure (MPa)
- S : Effective cross-sectional area of the narrow part (mm²)

(2) Subsonic flow

$$\frac{P_1 + 0.1013}{P_2 + 0.1013} \leq 1.89$$

$$Q = 226 \times S \times \sqrt{(P_2 + 0.1013) \times (P_1 - P_2)}$$

- Q : Air flow rate (ℓ/min. atmospheric pressure basis)
- P₁ : Primary pressure (MPa)
- P₂ : Secondary pressure (MPa)
- S : Effective cross-sectional area of the narrow part (mm²)

Negative Pressure Performance List

Product name	Unit	Standard						
		Absolute vacuum ←			→ Atmospheric pressure			
		Gauge pressure [Gauge]	-101.308kPa G	-101.29467kPa G	-101.1747kPa G	-99.975kPa G	-98.642kPa G	0kPa G
			-760mmHg G	-759.9mmHg G	-759mmHg G	-750mmHg G	-740mmHg G	0mmHg G
			-760Torr G	-759.9Torr G	-759Torr G	-750Torr G	-740Torr G	0Torr G
		Absolute pressure [abs]	0kPa abs	0.0134kPa abs	0.1333kPa abs	1.333kPa abs	2.666kPa abs	101.308kPa abs
0mmHg abs	0.1mmHg abs		1mmHg abs	10mmHg abs	20mmHg abs	760mmHg abs		
0Torr abs	0.1Torr abs		1Torr abs	10Torr abs	20Torr abs	760Torr abs		
Tube (*1) (U5,U2,U1,UE,N5,N2,N1, TES,PL,PN,TP,TA, 1300,PB,UC,USC,UMC,UML,S)								
PushOne series	A series							
	E series							
QuickSeal series	Insertion type							
	Insertless type							
Bamboo-shoot fitting series	Barb type							
Chemifit series	C1 series							
	C1S series							
	CS series							
	CSA series							
	CP series							
Switch and detachable series (*2)	Q.D.C 101 series							
	Q.D.C 103 series							
	Miniature valve							

 Shaded area : Usable

(*1) Influence of permeation, etc on the operation fluid should be checked under your company's use conditions.

(*2) Other control and switch products (speed controller, ball valve, throttle valve, and valve built-in connector) cannot be used at a negative pressure.

About explanations of Negative Pressure Performance

In pages introducing each Product, Gauge pressure is adopted as the standard unit of Negative Pressure Performance.

Therefore Negative Pressure Performance is indicated adding prefix minus.

In addition, the character "G" is omitted on signage of the unit.

Tube

Clean tube

Processed tube

PushOne fitting

QuickSeal fitting

Clean fitting/ Chemifit

Bamboo-shoot fitting

Control switch/ Detachable series

Jig/Tool/ Accessory

Technical information

Reference

Instruction Manual for PushOne® A and E series

1 Preparation

Prepare a tube cutter and attachment tools of an appropriate size.



(Note)

- ☞ Select an appropriate tube cutter TC01, TC04 or HC03 for the tube size. See Table 1 for the applicable tube size of each cutter.
- ☞ Seal processed thread of the PushOne series does not require sealing tape.

- ⚠ Caution Close the tube cutter blades when not using the cutter.
- ⚠ Caution Check that the fitting and the tube meet the specifications of the piping environment. Incorrect selection of products may cause an extremely serious accident.

[Table 1] Applicable tube size of tube cutter

Tube cutter product number	Applicable tube outer diameter(mm)
TC01	~13(1/2inch)
TC04	~13(1/2inch)
HC03	~20(3/4inch)

2 Attaching a fitting (re-attaching a fitting)

Use appropriate-size attachment tools to attach a fitting. Tighten the fitting to the recommended tightening torque given in Table 2.



(Note)

- ☞ Usually, processed seal can be used two or three times.
- ☞ When the processed seal becomes less effective, bind sealing tape around the seal-processed thread. The sealing tape should be bound 2-2.5 times in the correct direction, leaving one or two ridges unsealed from the end.



- ⚠ Caution When a hexagon spanner is used for hexagon socket connector, be sure not to touch the lock ring part or the tube seal part of the fitting to prevent disconnection of tube and leakage.
- ⚠ Caution Over-tightening of M thread could break the thread part or deform gasket, causing leakage. Be sure to tighten the thread to the recommended torque.
- ⚠ Caution When reattaching a fitting, be careful not to let the sealing material of the seal processed part contaminate operating fluid.

[Table 2] Recommended tightening torque for PushOne series

Thread size (JIS B 0205 : 2001) (JIS B 0203 : 1999)	Recommended tightening torque (N · m)
M3	0.7
M5	1.2
M6	2.0
R1/8	7.0-9.0
R1/4	12.0-14.0
R3/8	22.0-24.0
R1/2	28.0-30.0

3 Cutting tube

Cut the tubes at a right angle with a tube cutter. Clean the surfaces of tubes before cutting. Select undented, undamaged, well-shaped tubes.



- ⚠ Caution Do not leave dirt, dents, damage, deformations, burrs, or fluff on the cut surface. Do not cut tubes at a titled angle. The seal of the connection could be damaged, causing leakage.

4 Connecting tube and finishing work.

Insert the tube steadily straight to the fitting until the tube reaches the end. After inserting the tube, try to pull it out gently and check that it will not pop out.



(Note)

- ☞ The insertion length of the tube is summarized in Table 3. See the table for reference.
- ☞ Before inserting a tube, mark the tube at the insertion length from the end so that you can check if the tube is properly inserted. See Table 3 for the tube insertion length. If the mark comes to the edge of the release sleeve and if the tube would not be pulled out easily, the tube connection work is completed.



- ☞ The millimeter and the inch size types of the PushOne E series are distinguished by a punch mark (of tube size) on the release sleeve and the release sleeve color (millimeter: blue, inch: white). φ8 and φ5/16 types share a release sleeve mold with the same size mark, and therefore should be distinguished only by the release sleeve color.

Caution An improperly inserted tube may cause disconnection or leakage.

Caution If you use other manufacturers' tubes to make the connection, check the outer diameter tolerance of the tube lies in the range of the size tolerance given in Table 4. If it does not, leakage may occur.

[Table 3] Insertion length of PushOne series tube

PushOne series	Applicable tube outer diameter(mm)	Insertion length of tube (mm)
PushOne E series Mini type	3	9
	4	10
	6	11
PushOne A series PushOne E series	4	13
	6	15
	8	16
	10	19
	12	20
	16	27
	6.35(1/4inch)	15
	7.94(5/16inch)	16
	9.53(3/8inch)	19
	12.70(1/2inch)	21

[Table 4] Outer diameter tolerance of applicable tube

Tube material	Outer diameter tolerance of tube (mm)
Polyurethane tube	±0.1
Nylon tube	±0.1

5 Disconnecting tube

Re-insert the tube into the fitting body until the tube reaches the end, and pull it out straight from the fitting while pushing the release sleeve evenly with two fingers. Do not twist the tube when pulling it out.



Caution If you try to pull out or twist a tube without re-inserting it until it reaches the end and without sufficiently pressing the release sleeve, the tube will not come out.

Caution Be sure to make the internal pressure zero before disconnecting a tube.

6 Re-connecting tube

Repeat the steps from “3. Cutting tube”. If you re-connect a disconnected tube, cut off the tip where a claw pattern is left. Also, confirm that there is no dirt, dents, damage, or deformations on the tube.

Caution In case internal pressure or heat changes the inner and outer diameters of tube, replace the tube with a new one.

Instruction Manual for QuickSeal series

1 Preparation

Prepare a tube cutter, attachment tools of an appropriate size and sealing tape.



(Note)

- ☞ Select an appropriate tube cutter TC01, TC04 or HC03 for the tube size. See Table 1 for the applicable tube size of each cutter.
- ☞ The seal processed brass connector of the PushOne series does not require sealing tape.

- ⚠ Caution Close the tube cutter blades when not using the cutter.
- ⚠ Caution Check that the fitting and the tube meet the specifications of the piping environment. Incorrect selection of products may cause an extremely serious accident.

[Table 1] Applicable tube size of tube cutter

Tube cutter product number	Applicable tube outer diameter(mm)
TC01	~13(1/2inch)
TC04	~13(1/2inch)
HC03	~20(3/4inch)

2 Binding sealing tape (re-attachment of seal)

The sealing tape should be bound 2-2.5 times in the correct direction, leaving one or two ridges unsealed from the end. Seal processed brass connector of the PushOne series does not require sealing tape.



(Note)

- ☞ When the seal on brass connector becomes less effective, bind sealing tape around the seal processed thread.
- ☞ Usually, a processed seal can be used two or three times.

- ⚠ Caution When reattaching a seal-processed product, be careful not to let the sealing material contaminate the operating fluid.
- ⚠ Caution When reattaching a fitting other than seal-processed products, remove the old seal on the thread and bind with new sealing tape. The old sealing tape could contaminate the operating fluid and cause problems.

3 Attaching a fitting

Use appropriate-size attachment tools to attach a fitting. Tighten the fitting to the recommended tightening torque given in Table 2.

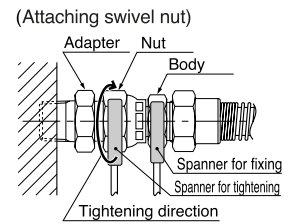

First, tighten by hand. Then tighten the nut with a torque wrench while fixing the nipple with a spanner.

- ⚠ Caution The thread may become seized with high heat in the stainless type of fitting. Tighten slowly to prevent the thread from seizing.
- ⚠ Caution Quick rotation of a torque wrench to tighten a swivel nut fitting generates small pressure on the sheet surface and could cause leakage.

[Table 2] Recommended tightening torque for QuickSeal series

Thread size (JIS B 0203 : 1999) (JIS B 0202 : 1999)	Recommended tightening torque (N · m)
R1/8	7.0-9.0
R1/4	12.0-14.0
R3/8	22.0-24.0
R1/2	28.0-30.0
G1/8	15
G1/4	25
G3/8	50
G1/2	60

4 Cutting tube

Cut the tubes at a right angle with a tube cutter. Clean the surfaces of tubes before cutting. Select undented, undamaged, well-shaped tubes.



(Note)

- ☞ When you cut a DK tube, be sure not to deform the tube tip. An old blade cutter may cause deformation. Use a new tube cutter in this case.
- ☞ Use hose cutter HC01 for cutting S3/4-type nylon coil tube.

- ⚠ Caution Do not leave dirt, dents, damage, deformations, burrs, or fluff on the cut surface. Do not cut the tubes at a tilted angle. The seal of the connection, causing leakage.

5 Inserting nut and sleeve

Insert a nut and a sleeve to a tube as shown in the photograph. The sleeve has a correct insertion direction. The thicker part should face the tube end direction. Leave a space of more than 1cm long between the sleeve and the tube end.



(Note)

☞ The millimeter and the inch size types of the QuickSeal series insertion type are distinguished by a punch mark (of tube size) on the fitting body, the cut on the nut, and the sleeve color (millimeter: milky white, inch: black).

☞ Use a tube insertion part (SI 3/4) for 3/4-size nylon coil tube QuickSeal fitting.

Brass type



Stainless type

**6 Inserting tube**

Insert the tube to the fitting body until the tube reaches the end.

**(Note)**

☞ The insertion length of the tube is summarized in Table 3. See the table for reference.

⚠ Caution If you use other manufacturers' tubes to make the connection, check the outer diameter tolerance of the tube lies in the range of the size tolerance given in Table 4. If it does not, leakage may occur. An improperly inserted tube may cause disconnection or leakage.

[Table 3] Insertion length of QuickSeal series tube

Type	Applicable tube outer diameter (mm)	Insertion length of tube (mm)	Type	Applicable tube outer diameter (mm)	Insertion length of tube (mm)				
Insertion type (group 4) DK tube dedicated type	4	15	Insertion type (group 2)	3.18(1/8inch)	21				
	6	15							
	8	16	Insertless type	4	14				
	10	17		6	14				
12	18	8		15					
16	23	10		18					
Insertion type (group 1) Insertion type (group 2)	3.18(1/8inch)	15	Type	Applicable tube product number	Insertion length of tube (mm)				
	4.76(3/16inch)	15							
	6.35(1/4inch)	15							
	7.94(5/16inch)	16							
	9.53(3/8inch)	17							
Nylon coil tube dedicated type	12.70(1/2inch)	18	S3/16	S1/4	S3/8				
	15.88(5/8inch)	23				S1/2	S3/4		
								S3/16	16
		S3/8	22						
				S1/2	29				
						S3/4	31		

[Table 4] Outer diameter tolerance of applicable tube

Tube material	Outer diameter tolerance of tube (mm)
Polyurethane tube	±0.1
Nylon tube	±0.1

7 Tightening nuts by hand

Tighten the nut by hand.

**(Note)**

☞ It is recommended to mark the nut and the fitting body at the hand tightened position in order to check the number of rotations of the nut.

**8 Tightening nuts and finishing work**

Tighten the hand tightened nut with a spanner or a crescent wrench according to the appropriate number of rotations for tightening the nut given in Table 5.

**(Note)**

☞ Before inserting a tube, mark the tube at the insertion length from the end so that you can check if the tube is properly inserted. If the marking moves 1-2mm from the sleeve end by tightening the nut, it is a sign that the nut is properly tightened.



⚠ Caution The thread may become seized with high heat in the stainless type of fitting. Tighten slowly to prevent seizing of thread.

⚠ Caution The appropriate number of rotations for tightening nuts varies depending on the size and material of sleeve. Be sure to check the appropriate number of rotations.

⚠ Caution For use of the QuickSeal series at a high temperature within the working temperature range, tighten the nut periodically. If the nut cannot be tightened further, cut off the tube end as well as the sleeve and repeat the steps from "4. Cutting tube" with a new sleeve.

[Table 5] Appropriate number of rotations for tightening nuts

Sleeve material	Applicable tube outer diameter (mm)	Appropriate number of rotations for tightening nuts	Sleeve material	Applicable tube outer diameter (mm)	Appropriate number of rotations for tightening nuts										
Nylon sleeve	4	2-2.5	Brass sleeve	4	1-1.5										
	6	2-2.5		6	1-1.5										
	8	2-2.5		8	1-1.5										
	10	2-2.5		10	1.5-2										
	12	2-2.5		12	1.5-2										
Nylon sleeve	16	2-2.5	Nylon coil tube dedicated type	Type	Applicable tube product number										
	3.18(1/8inch)	2-3				S3/16	S1/4								
	4.76(3/16inch)	2-3						S3/8	S1/2						
	6.35(1/4inch)	2-3								S3/4	S3/4				
	7.94(5/16inch)	2-3										S3/16	1.5-2		
	9.53(3/8inch)	2-3												S1/4	2-2.5
	12.70(1/2inch)	2-3													
15.88(5/8inch)	2.5-3	S1/2	2.5-3												
				S3/4	2-2.5										

9 Re-connecting tube

Cut off the tube end as well as the sleeve and repeat the steps from "4. Cutting tube" with a new sleeve. Confirm that there is no dirt, dents, damage, and or deformations on the tube surface.

(Note)

☞ If you reuse a nut, check that the nut is not damaged. A damaged nut could cause problems such as improper tightening or leakage.

⚠ Caution In case internal pressure or heat changes the inner and outer diameters of tube, replace the tube with a new one.

Instruction Manual for Chemifit® C1 series

Tube

Clean tube

Processed tube

PushOne fitting

QuickSeal fitting

Clean fitting/ Chemifit

Bamboo-shoot fitting

Control switch/ Detachable series

Jig/Tool/ Accessory

Technical information

Reference

1 Preparation

Prepare a tube cutter and crescent wrench, and sealing tape.



(Note)

Select an appropriate tube cutter TC01 or TC04 for the tube size. See Table 1 for the applicable tube size of each cutter.

- Caution** Close the tube cutter blades when not using the cutter.
- Caution** Check that the fitting and the tube meet the specifications of the piping environment. Incorrect selection of products may cause an extremely serious accident.

[Table 1] Applicable tube size of tube cutter

Tube cutter product number	Applicable tube outer diameter(mm)
TC01	~13(1/2inch)
TC04	~13(1/2inch)

2 Binding sealing tape

The sealing tape should be bound 2-2.5 times in the correct direction, leaving one or two ridges unsealed from the end.



3 Attaching a fitting

First, tighten a fitting by hand. Then tighten it about two turns with a crescent wrench.



- Caution** Over-tightening could damage the resin thread and cause deformation and leakage.
- Caution** Use a crescent wrench to tighten the hexagonal (HEX) part, which is made of resin. Using a spanner could cause damage to the HEX part.

4 Cutting tube

Cut the tubes at a right angle with a tube cutter. Clean the surfaces of tubes before cutting. Select undented, undamaged, well-shaped tubes.



- Caution** Do not leave dirt, dents, damage, deformations, burrs, or fluff on the cut surface. Do not cut tubes at a titled angle. The seal of the connection could be damaged, causing leakage.

5 Connecting tube and finishing work.

Insert the tube steadily straight to the fitting until the tube reaches the end. After inserting the tube, try to pull it out gently and check that it will not pop out.



(Note)

- The millimeter and the inch size types of the Chemifit C1 series are distinguished by a punch mark of tube size on the release sleeve.
- The insertion length of the tube is summarized in Table 2. See the table for reference.

- Caution** An improperly inserted tube may cause disconnection or leakage.
- Caution** Chemifit C1 series has a resin thread, which allows stress relaxation relatively easily compared to metal thread. In some cases oozing leakage occurs. In particular at a high temperature, tighten the fitting periodically. If the fitting cannot be tightened further, replace it with a new one.
- Caution** If you use other manufacturers' tubes to make the connection, use a tube with a size tolerance within ± 0.1 mm. Otherwise, leakage may occur.

[Table 2] Insertion length of Chemifit C1 series tube

Series name	Applicable tube outer diameter(mm)	Insertion length of tube (mm)
Chemifit C1 series	3	11
	4	14
	6	15
	8	16
	10	19
	12	20
	3.18(1/8inch)	11
	6.35(1/4inch)	16
	9.53(3/8inch)	20
	12.70(1/2inch)	23

6 Disconnecting tube

Re-insert the tube into the fitting body until the tube reaches the end, and pull it out straight from the fitting while pushing the release sleeve evenly with two fingers. Do not twist the tube when pulling it out.



- ⚠ Caution** If you try to pull out or twist a tube without re-inserting it until it reaches the end and without sufficiently pressing the release sleeve, the tube will not come out.
- ⚠ Caution** Be sure to make the internal pressure zero before disconnecting a tube.

7 Re-connecting tube

Repeat the steps from “4. Cutting tube”. If you re-connect a disconnected tube, cut off the tip where a claw pattern is left. Also, confirm that there is no dirt, dents, damage, or deformations on the tube.

- ⚠ Caution** In case internal pressure or heat changes the inner and outer diameters of tube, replace the tube with a new one.

Tube

Clean tube

Processed tube

PushOne fitting

QuickSeal fitting

Clean fitting/
Chemifit

Bambooshoot fitting

Control switch/
Detachable series

Jig/Tool/
Accessory

Technical information

Reference

Instruction Manual for Chemifit® C1S series

Tube

Clean tube

Processed tube

PushOne fitting

QuickSeal fitting

Clean fitting/Chemifit

Bamboo-shoot fitting

Control switch/Detachable series

Jig/Tool/Accessory

Technical information

Reference

1 Preparation

Prepare a tube cutter, attachment tools of an appropriate size and sealing tape.



(Note)

Select an appropriate tube cutter TC01 or TC04 for the tube size. See Table 1 for the applicable tube size of each cutter.

- ⚠ Caution Close the tube cutter blades when not using the cutter.
- ⚠ Caution Check that the fitting and the tube meet the specifications of the piping environment. Incorrect selection of products may cause an extremely serious accident.

[Table 1] Applicable tube size of tube cutter

Tube cutter product number	Applicable tube outer diameter(mm)
TC01	~13(1/2inch)
TC04	~13(1/2inch)

2 Binding sealing tape

The sealing tape should be bound 2-2.5 times in the correct direction, leaving one or two ridges unsealed from the end.



- ⚠ Caution When reattaching the fitting body, remove the old seal on the thread and bind with new sealing tape. The old sealing tape could contaminate the operating fluid and cause problems.

3 Attaching a fitting

Use appropriate-size attachment tools to attach a fitting. Tighten the fitting to the recommended tightening torque given in Table 2.



- ⚠ Caution Tighten slowly to prevent the thread from seizing.
- ⚠ Caution Over-tightening of M thread could break the thread or deform the gasket, causing leakage. Be sure to tighten it to the recommended torque.

[Table 2] Recommended tightening torque for Chemifit C1S series

Thread size (JIS B 0205 : 2001) (JIS B 0203 : 1999)	Recommended tightening torque (N · m)
M5	1.2
R1/8	7.0-9.0
R1/4	12.0-14.0
R3/8	22.0-24.0
R1/2	28.0-30.0

4 Cutting tube

Cut the tubes at a right angle with a tube cutter. Clean the surfaces of tubes before cutting. Select undented, undamaged, well-shaped tubes.



- ⚠ Caution Do not leave dirt, dents, damage, deformations, burrs, or fluff on the cut surface. Do not cut tubes at a tilted angle. The seal of the connection could be damaged, causing leakage.

5 Connecting tube and finishing work.

Insert the tube steadily straight to the fitting until the tube reaches the end. After inserting the tube, try to pull it out gently and check that it will not pop out.



(Note)

 The millimeter and the inch size types of the Chemifit C1S series are distinguished by a punch mark of tube size on the release sleeve. The insertion length of the tube is summarized in Table 3. See the table for reference.

 **Caution** An improperly inserted tube may cause disconnection or leakage.

 **Caution** If you use other manufacturers' tubes to make the connection, use a tube with a size tolerance within ± 0.1 mm. Otherwise, leakage may occur.

[Table 3] Insertion length of Chemifit C1S series tube

Series name	Applicable tube outer diameter(mm)	Insertion length of tube (mm)
Chemifit C1S series	3	11
	4	14
	6	15
	8	16
	10	19
	12	20
	3.18(1/8inch)	11
	6.35(1/4inch)	16
	9.53(3/8inch)	20
12.70(1/2inch)	23	

6 Disconnecting tube

Re-insert the tube into the fitting body until the tube reaches the end, and pull it out straight from the fitting while pushing the release sleeve evenly with two fingers. Do not twist the tube when pulling it out.



 **Caution** If you try to pull out or twist a tube without re-inserting it until it reaches the end and without sufficiently pressing the release sleeve, the tube will not come out.

 **Caution** Be sure to make the internal pressure zero before disconnecting a tube.

7 Re-connecting tube

Repeat the steps from "4. Cutting tube". If you re-connect a disconnected tube, cut off the tip where a claw pattern is left. Also, confirm that there is no dirt, dents, damage, or deformations on the tube.

 **Caution** In case internal pressure or heat changes the inner and outer diameters of tube, replace the tube with a new one.

Instruction Manual for Chemifit® CSA series

1 Preparation

Prepare a tube cutter, attachment tools of an appropriate size and sealing tape.



(Note)

Select an appropriate tube cutter TC01, TC04, HC03 or HC01 for the tube size. See Table 1 for the applicable tube size of each cutter.

- ⚠ Caution Close the tube cutter blades when not using the cutter.
- ⚠ Caution Check that the fitting and the tube meet the specifications of the piping environment. Incorrect selection of products may cause an extremely serious accident.

[Table 1] Applicable tube size of tube cutter

Tube cutter product number	Applicable tube outer diameter(mm)
TC01	~13(1/2inch)
TC04	~13(1/2inch)
HC03	~20(3/4inch)

2 Binding sealing tape (re-binding)

The sealing tape should be bound 2-2.5 times in the correct direction, leaving one or two ridges unsealed from the end.



- ⚠ Caution When reattaching the fitting body, remove the old seal on the thread and bind with new sealing tape. The old sealing tape could contaminate the operating fluid and cause problems.

3 Attaching a fitting body

Use appropriate-size attachment tools to attach a fitting. Tighten the fitting to the recommended tightening torque given in Table 2.



- ⚠ Caution Tighten slowly to prevent the thread from seizing.

[Table 2] Recommended tightening torque for Chemifit CSA series

Thread size (JIS B 0203 : 1999)	Recommended tightening torque (N · m)
R1/8	7.0-9.0
R1/4	12.0-14.0
R3/8	22.0-24.0
R1/2	28.0-30.0

4 Cutting tube

Cut the tubes at a right angle with a tube cutter. Clean the surfaces of tubes before cutting. Select undented, undamaged, well-shaped tubes.



- ⚠ Caution Do not leave dirt, dents, damage, deformations, burrs, or fluff on the cut surface. Do not cut tubes at a tilted angle. The seal of the connection could be damaged, causing leakage.

5 Inserting assembly nut

Insert an assembly nut to a tube in such a direction that the thread part faces the tube end.



6 Inserting tube

Insert the tube to the fitting body until the tube reaches the end.



(Note)

- ☞ The insertion length of the tube is summarized in Table 3. See the table for reference.
- ☞ The millimeter and the inch size types of the Chemifit CSA series are distinguished by a boss at the internal sleeve as shown on the right.

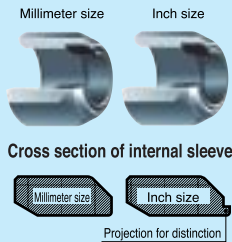

- ⚠ Caution If you use other manufacturers' tubes to make the connection, use a tube with a size tolerance within ± 0.1 mm. Otherwise, leakage may occur.
- ⚠ Caution An improperly inserted tube may cause disconnection or leakage.

[Table 3] Insertion length of Chemifit CSA series tube

Applicable tube outer \times inner diameters (mm)	Insertion length of tube (mm)
4 \times 2	5.5
6 \times 4	7.0
8 \times 5	7.5
8 \times 6	7.5
10 \times 6.5	8.5
10 \times 8	8.5
12 \times 9	10.0
12 \times 10	10.0
19 \times 16	12.5
6.35 \times 4.57(1/4inch)*	7.0
9.53 \times 6.99(3/8inch)*	8.5
12.70 \times 9.56(1/2inch)*	10.5

*Tube outer diameter

7 Tightening nuts by hand

Tighten the assembly nut by hand.



8 Tightening nuts

Tighten the hand-tightened nut with a spanner or a crescent wrench until the nut reaches the fitting body.



9 Tightening completed

If the assembly nut touches the fitting body, the assembling is completed.



10 Re-connecting tube

Cut off the tube end and repeat the steps from "4. Cutting tube". Confirm that there is no dirt, dents, damage, or deformations on the tube surface.

(Note)

- ☞ If you reuse an assembly nut, check if the internal sleeve is not damaged. Damage assembly nut could cause problems such as leakage.

- ⚠ Caution Be sure to make the internal pressure zero before disconnecting a tube.
- ⚠ Caution In case internal pressure or heat changes the inner and outer diameters of tube, replace the tube with a new one.

Instruction Manual for Chemifit® CS series

Tube

Clean tube

Processed tube

PushOne fitting

QuickSeal fitting

Clean fitting/ Chemifit

Bamboo-shoot fitting

Control switch/ Detachable series

Jig/Tool/ Accessory

Technical information

Reference

1 Preparation

Prepare a tube cutter, attachment tools of an appropriate size and sealing tape.



(Note)

Select an appropriate tube cutter TC01, TC04, HC03 or HC01 for the tube size. See Table 1 for the applicable tube size of each cutter.

- ⚠ Caution Close the tube cutter blades when not using the cutter.
- ⚠ Caution Check that the fitting and the tube meet the specifications of the piping environment. Incorrect selection of products may cause an extremely serious accident.

[Table 1] Applicable tube size of tube cutter

Tube cutter product number	Applicable tube outer diameter(mm)
TC01	~13(1/2inch)
TC04	~13(1/2inch)
HC03	~20(3/4inch)

2 Binding sealing tape (re-binding)

The sealing tape should be bound 2-2.5 times in the correct direction, leaving one or two ridges unsealed from the end.



- ⚠ Caution When reattaching the fitting body, remove the old seal on the thread and bind with new sealing tape. The old sealing tape could contaminate the operating fluid and cause problems.

3 Attaching a fitting body

Use appropriate-size attachment tools to attach a fitting. Tighten the fitting to the recommended tightening torque given in Table 2.



- ⚠ Caution Tighten slowly to prevent the thread from seizing.

[Table 2] Recommended tightening torque for Chemifit CS series

Thread size (JIS B 0203 : 1999)	Recommended tightening torque (N · m)
R1/8	7.0-9.0
R1/4	12.0-14.0
R3/8	22.0-24.0
R1/2	28.0-30.0

4 Cutting tube

Cut the tubes at a right angle with a tube cutter. Clean the surfaces of tubes before cutting. Select undented, undamaged, well-shaped tubes.



- ⚠ Caution Do not leave dirt, dents, damage, deformations, burrs, or fluff on the cut surface. Do not cut tubes at a tilted angle. The seal of the connection could be damaged, causing leakage.

5 Inserting nut and sleeve

Insert a nut and a sleeve to tube as shown in the photograph. The sleeve has an appropriate insertion direction. The tapered side of the sleeve surface should face the nut. Leave a space of more than 1cm long between the tube end and the sleeve.

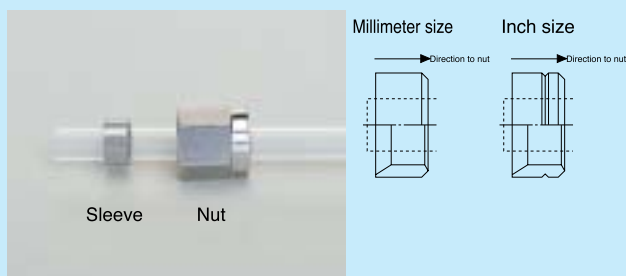

Caution Sleeve inserted in a wrong direction cannot be properly tightened and could cause leakage or tube disconnection. Be careful to insert in the correct direction.

6 Inserting tube

Insert the tube to the fitting body until the tube reaches the end.



(Note)

- The millimeter and the inch size types of the Chemifit CS series are distinguished by a punch mark of tube size on the fitting body.
- The insertion length of the tube is summarized in Table 3. See the table for reference.

Caution If you use other manufacturers' tubes to make the connection, use a tube with a size tolerance within ± 0.1 mm. Otherwise, leakage may occur.

Caution An improperly inserted tube may cause disconnection or leakage.

[Table 3] Insertion length of Chemifit CS series tube

Applicable tube outer \times inner diameters (mm)	Insertion length of tube (mm)
4 \times 2	5.5
6 \times 4	7.0
8 \times 6	7.5
10 \times 8	8.5
12 \times 9	10.0
12 \times 10	10.0
19 \times 16	12.5
6.35 \times 4.57(1/4inch)*	7.0
9.53 \times 6.99(3/8inch)*	8.5
12.70 \times 9.56(1/2inch)*	10.5

*Tube outer diameter

7 Tightening nuts by hand

Tighten the nut by hand.



8 Tightening nuts

Tighten the hand tightened nut with a spanner or a crescent wrench until the nut reaches the fitting body.



9 Tightening completed

If the nut touches the fitting body, the assembling is completed.



10 Re-connecting tube

Cut off the tube end as well as the sleeve and repeat the steps from "4. Cutting tube" with a new sleeve. Confirm that there is no dirt, dents, damage, or deformations on the tube surface.

(Note)

- If you reuse a nut, check if the nut is not damaged. A damaged nut could cause problems such as improper tightening or leakage.

Caution Be sure to make the internal pressure zero before disconnecting a tube.

Caution In case internal pressure or heat changes the inner and outer diameters of tube, replace the tube with a new one.

Instruction Manual for Chemifit® CP series

Tube

Clean tube

Processed tube

PushOne fitting

QuickSeal fitting

Clean fitting/ Chemifit

Bamboo-shoot fitting

Control switch/ Detachable series

Jig/Tool/ Accessory

Technical information

Reference

1 Preparation

Prepare a tube cutter, a crescent wrench and sealing tape.



(Note)

Select an appropriate tube cutter TC01 or TC04 for the tube size. See Table 1 for the applicable tube size of each cutter.

- ⚠ Caution Close the tube cutter blades when not using the cutter.
- ⚠ Caution Check that the fitting and the tube meet the specifications of the piping environment. Incorrect selection of products may cause an extremely serious accident.

[Table 1] Applicable tube size of tube cutter

Tube cutter product number	Applicable tube outer diameter(mm)
TC01	~13(1/2inch)
TC04	~13(1/2inch)

2 Binding sealing tape

The sealing tape should be bound 2-2.5 times in the correct direction, leaving one or two ridges unsealed from the end.



3 Attaching a fitting body

First, tighten a fitting by hand. Then tighten it about two turns with a crescent wrench.



- ⚠ Caution Over-tightening could damage the resin fitting body and cause deformation and leakage.
- ⚠ Caution Use a crescent wrench to tighten the hexagonal (HEX) part, which is made of resin. Using a spanner could cause damage to the HEX part.

4 Cutting tube

Cut the tubes at a right angle with a tube cutter. Clean the surfaces of tubes before cutting. Select undented, undamaged, well-shaped tubes.



- ⚠ Caution Do not leave dirt, dents, damage, deformations, burrs, or fluff on the cut surface. Do not cut tubes at a tilted angle. The seal of the connection could be damaged, causing leakage.

5 Inserting nut and sleeve (inserting insertion part)

Insert a nut and then a sleeve to a tube. Leave a space of more than 1cm long between the tube end and the sleeve. (It is recommended to use an insertion part for flexible tubes such as polyolefine tube.)

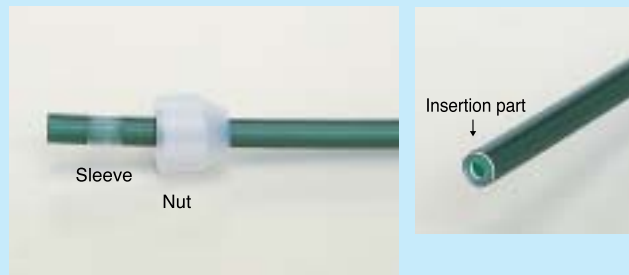

6 Inserting tube

Insert the tube to the fitting body until the tube reaches the end.



(Note)

The millimeter and the inch size types of the Chemifit CP series are distinguished by the shape of the sleeve. The insertion length of the tube is summarized in Table 2. See the table for reference.

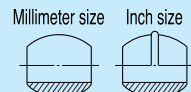

- ⚠ Caution If you use other manufacturers' tubes to make the connection, use a tube with a size tolerance within ± 0.1 mm. Otherwise, leakage may occur.
- ⚠ Caution An improperly inserted tube may cause disconnection or leakage.

[Table 2] Insertion length of Chemifit CP series tube

Applicable tube outer diameter(mm)	Insertion length of tube (mm)
4	16
6	18
8	20
10	25
12	29
6.35(1/4 inch)	18
9.53(3/8 inch)	25
12.70(1/2 inch)	29

7 Tightening nuts by hand

Tighten the nut by hand with the tube being inserted to the fitting body.



8 Tightening nuts

Tighten the hand-tightened nut 1.5 to 2 turns with a crescent wrench.



Caution Use a crescent wrench to tighten the hexagonal (HEX) part, which is made of resin. Using a spanner could cause damage to the HEX part.

9 Tightening completed

If there is an appropriate space left between the nut and the fitting body as described in Table 3, the assembling is completed.



[Table 3] Space between the nut and the fitting body of the Chemifit CP series

Applicable tube outer diameter(mm)	Space between the nut and the fitting body(mm)	Remaining number of ridges
4	0.5	1
6	1.0	1
8	2.5	1.5
10	3.5	2
12	3.5	2
6.35(1/4 inch)	1.0	1
9.53(3/8 inch)	1.0	1
12.70(1/2 inch)	2.5	1.5

Caution The Chemifit CP series has a resin thread, which allows stress relaxation relatively easily compared to metal thread. In some cases leakage occurs. In particular at a high temperature, tighten the fitting periodically. If the fitting cannot be tightened further, replace it with a new one.

10 Re-connecting tube

Cut off the tube end and repeat the steps from “4. Cutting tube” with a new sleeve (and insertion part). Confirm that there is no dirt, dents, damage, or deformations on the tube surface.

Caution Be sure to make the internal pressure zero before disconnecting a tube.

Caution The Chemifit CP series is made of resin and hence the nut and body could be deformed. Confirm that the nut and body are not damaged. A damaged nut and body would cause leakages.

Caution In case internal pressure or heat changes the inner and outer diameters of tube, replace the tube with a new one.

Instruction Manual for Q.D.C 101 and 103 series

Tube

Clean tube

Processed tube

PushOne fitting

QuickSeal fitting

Clean fitting/Chemifit

Bamboo-shoot fitting

Control switch/Detachable series

Jig/Tool/Accessory

Technical information

Reference

101 series

(Note)

See instruction manuals of appropriate specifications such as those of the PushOne series or QuickSeal series for handling thread and tube connection parts.

- ⚠ Caution Rotational use of a coupler and a nipple is not recommended.
- ⚠ Caution Use the product at a pressure lower than the maximum working pressure.
- ⚠ Caution Do not use the product under too much bending stress or tension.

1 Connection of coupler and nipple

Make the residual pressure on the coupler side zero. Check that there is no foreign matter in the connection part. Then insert the nipple to the coupler without pulling the sleeve on the coupler.

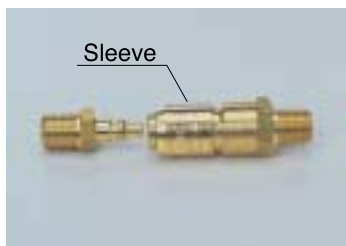

- ⚠ Warning Do not hit the valve head with a hammer, etc, to release residual pressure. It could break the valve and be extremely dangerous.
- ⚠ Caution Connection without releasing residual pressure may break the valve.
- ⚠ Caution Insert the nipple straight to the coupler.
- ⚠ Caution When connecting a coupler and a nipple, do not hold the sleeve of the coupler.

2 Disconnection of coupler and sleeve

Make the residual pressure on the coupler side zero. Pull out the coupler or the nipple to disconnect while pulling the sleeve of the coupler.

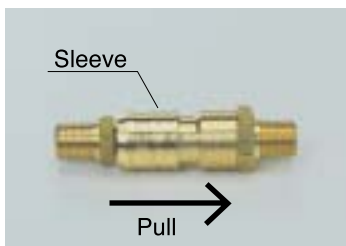

- ⚠ Warning Pay attention to the fact that disconnection without releasing residual pressure not only causes damage to the product body but will also cause an accident.

103 series

(Note)

See instruction manuals of appropriate specifications such as those of the PushOne series or QuickSeal series for handling thread and tube connection parts.

- ⚠ Caution Rotational use of a coupler and a nipple is not recommended.
- ⚠ Caution Use the product at a pressure lower than the maximum working pressure.
- ⚠ Caution Do not use the product under too much bending stress or tension.

1 Connection of coupler and nipple

Make the residual pressure on the coupler side zero. Check that there is no foreign matter in the connection part. Then insert the nipple to the coupler without pulling the sleeve on the coupler.



- ⚠ Warning Do not hit the valve head with a hammer, etc, to release residual pressure. It could break the valve and be extremely dangerous.
- ⚠ Caution Connection without releasing residual pressure may break the valve.
- ⚠ Caution Insert the nipple straight to the coupler.
- ⚠ Caution When connecting a coupler and a nipple, do not hold the sleeve of the coupler.

2 Disconnection of coupler and sleeve

Make the residual pressure on the coupler side zero. Pull out the coupler or the nipple to disconnect while pulling the sleeve of the coupler.

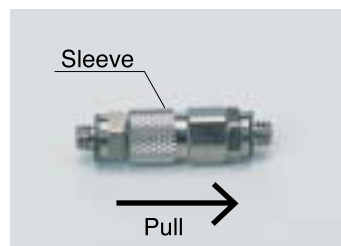

- ⚠ Warning Pay attention to the fact that disconnection without releasing residual pressure not only causes damage to the product body but will also cause an accident.

1 Preparation and cutting tube

Prepare a tube cutter and an outer cover peeling cutter of appropriate type described in Table 1. Cut the tubes at a right angle with a tube cutter. Clean the surfaces of tubes before cutting. Select undented, undamaged, well-shaped tubes.

(Note)

Select an appropriate tube cutter TC01 or TC04 for the tube size. See Table 2 for the applicable tube size of each cutter.

[Table 1] Product number of applicable outer cover peeling cutter

Tube type	Applicable tube outer diameter(mm)	Product number of applicable outer cover peeling cutter
FW	6	TC02
	8	
	10	
	12	
FWU	6	TC02U
	8	
	10	
	12	

[Table 2] Tube size applicable for tube cutter

Tube cutter product number	Applicable tube outer diameter(mm)
TC01	~13(1/2inch)
TC04	~13(1/2inch)

2 Inserting tube

Contact the cutting surface of tube with the blade in the insertion slot of the cutter.



Warning Do not insert your finger into the insertion slot of the outer cover peeling cutter.

Caution Do not use the cutter for tubes that Nitta Moore does not designate.

3 Peeling outer cover and pulling out tube

Slowly insert the tube while rotating to the contact surface in the cutter. When the tube reaches the contact surface, pull it out slowly while rotating in the opposite direction.

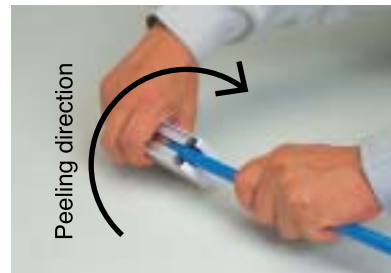

Warning Do not pull out a tube with a strong force or rotate it rapidly. It may cause damage to the cutter blade or the outer surface of the tube.

4 Removing outer cover

Remove the outer cover along the spiral cut line.



5 Completing work

The peeling work is completed if the peeled cover length satisfies the requirement shown in Table 3.



Table 3 Peeled outer cover length

FW/FWU tube outer diameter (mm)	Peeled outer cover length (mm)
6	15
8	16
10	19
12	20

Instruction Manual for Tube Reel

1 Check of type and size

Check the product number and applicable tube size and confirm that you have all the necessary parts.

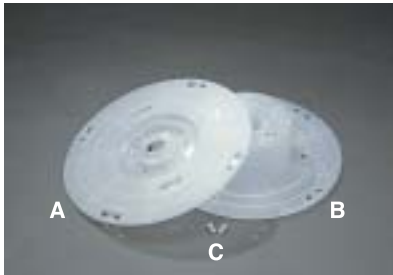

Applicable tube size

Millimeter size(mm)	Inch size(inch)	Applicable product number
4,6,8	3/16,1/4,5/16	PTR-1
10,12	3/8,1/2	PTR-2

☞ Set ϕ 8-size FW/FWU tube of 100m long to PTR-2.

Specification of each part

Part	Name	Material	Color	Quantity
A	Reel plate	Polypropylene (P.P.)	White	1
B	Reel body	Polypropylene (P.P.)	White	1
C*	Reel fixing pin	Polycarbonate + Nylon	White	2

*Product number of reel fixing pin is PTR-P.

Combination

Product number	Combination
PTR-1	A+B+C
PTR-2	B+B+C

2 How to set PTR-1

☞ For setting PTR-2, substitute "reel flange (A)" with "reel body (B)" in the following instruction and follow the same procedure.

2-1 Setting tube

Place the reel body (B) as shown in the photograph, and a bundled tube onto it. The tube is bundled with a tape. Place the tube in such a direction so that the inside tube end faces the clockwise direction.



(Note)

☞ It is recommended to cut the bundle tape somewhere inside and tape it temporarily onto the side of the bundle before you put the tube bundle onto the reel body.

2-2 Position adjustment of inside tube end

Pull out the inside tube end from the bundle tape and rotate the tube bundle for the tube end to reach a hook of the reel body (B).



2-3 Fixing inside tube end and setting reel flange

Cover the reel body with a reel flange (A) while inserting the position-adjusted tube end into an inner-side hole (nearer one of two holes) of the reel flange.



2-4 Fixing reel flange

Adjust the position of the reel flange (A) to match the positions of a notch of the reel flange (A) and the hook of the reel body (B). Rotate the reel flange (A) counterclockwise to interlock the notch and the hook. (Tip: Rotate the reel flange (A) pressing its center slightly.) Fit the positions of the fixing pin holes of the reel body (B) and the reel flange (A).

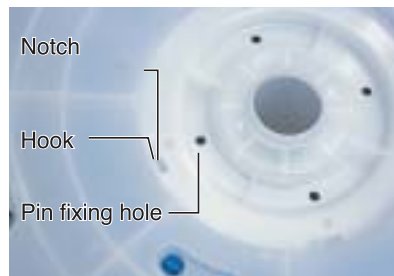

2-5 Part names of reel flange

Insert a reel fixing pin (C) into each of two fixing pin holes of the reel flange (A) to fix the plate with the reel body (B).



Tube

Clean tube

Processed tube

PushOne fitting

QuickSeal fitting

Clean fitting/ Chemifit

Bamboo-shoot fitting

Control switch/ Detachable series

Jig/Tool/ Accessory

Technical information

Reference

2-6 Setting inside tube end

The inside tube end coming out of the reel flange (A) should be re-inserted in the other hole of the reel flange (A) as in the photograph. Or rotate the tube bundle by hand to an appropriate position.



2-7 Completion of work

Insert the outside tube end into the outer-side hole of the reel flange (A) and remove the bundle tape. The assembly of the tube reel is completed.



Tube

Clean tube

Processed tube

PushOne fitting

QuickSeal fitting

Clean fitting/Chemifit

Bamboo-shoot fitting

Control switch/Detachable series

Jig/Tool/Accessory

Technical information

Reference

Instruction Manual for Spatter Cap

Tube

Clean tube

Processed tube

PushOne fitting

QuickSeal fitting

Clean fitting/
Chemifit

Bamboo-shoot fitting

Control switch/
Detachable series

Jig/Tool/
Accessory

Technical information

Reference

CP/CPF

1 Attachment of CP (CPF)

Insert CP (CPF) to a tube in such a direction that the larger diameter side faces the tube end.



⚠ Caution CP (CPF) can be used only for PushOne series (except mini type).

2 Inserting to tube fitting

Insert the tube to a fitting following the instruction manual of the PushOne series.



3 Setting CP (CPF)

Push CP (CPF) to cover the fitting body.



4 Completing work

Check if CP (CPF) is properly attached.



CPP

1 Inserting to tube fitting

Insert a tube to a fitting following the instruction manual of the PushOne series, and check if the tube is properly inserted.



2 Attaching CPP

Open CPP halved in advance and cover the tube connection part with it.



(Note)

👉 If you use CPP for FS tube, there will be a 1mm space between the outer surface of the FS tube and the inner surface of CPP.

⚠ Caution CPP can be used only for PushOne series (except mini type).

3 Fixing CPP

Fix the hook of the CPP and close the opened body.



Check if CPP is properly attached.



Put the guide of an off tool onto the outer surface of a tube. Insert the tube to the fitting body until it reaches the end. Pull out the tube straight from the fitting while pressing the release sleeve with the off toll.



⚠ Caution If you do not insert the tube sufficiently and do not press the release sleeve completely, pulling out or twisting the tube may cause permanent damage to the tube.

⚠ Caution Before you pull out tube, make the inside pressure zero.

Tube

Clean tube

Processed tube

PushOne fitting

QuickSeal fitting

Clean fitting/
Chemifit

Bambooshoot fitting

Control switch/
Detachable series

Jig/Tool/
Accessory

Technical information

Reference

Reference Information

INDEX

Applied Standard List

P.199

Screw Standard List

P.200

UL-94 Standard Flame Test

P.204

Table of Full Scale of Tube and Screw

P.205

Unit Conversion Table

P.206

Chemical Resistance Specification Table

P.207

(1) Test items and applied standard for pneumatic fitting

<Standard No.>
JIS B 8381-1995

<Test items>
① Flow rate characteristics test (effective cross-sectional area)
② Airtight test
③ Pressure resistance test
④ Repeated connection test
⑤ Pulling strength test
⑥ Durability test

(2) Test items and applied standard for pneumatic fitting tube (nylon tube, polyurethane tube).

<Standard No.>
JIS B 8381-1995 Appendix

<Test items>
① Minimum bending radius test
② Impact pressure test
③ Durability test

(3) Test items and applied standard for speed controller

<Standard No.>
JIS B 8376-1982 , JIS B 8381-1995

<Test items>
① Controlled flow rate characteristics test
② Free flow rate characteristics test
③ Pressure resistance test
④ Cracking pressure test of valve
⑤ Leaking test of valve
⑥ Durability test

Tube

Clean tube

Processed tube

PushOne fitting

QuickSeal fitting

Clean fitting/
Chemifit

Bambooshoot fitting

Control switch/
Detachable series

Jig/Tool/
Accessory

Technical information

Reference

Screw Standard List

Parallel Pipe Threads (JIS B 0202-1999)

1. Basic profile

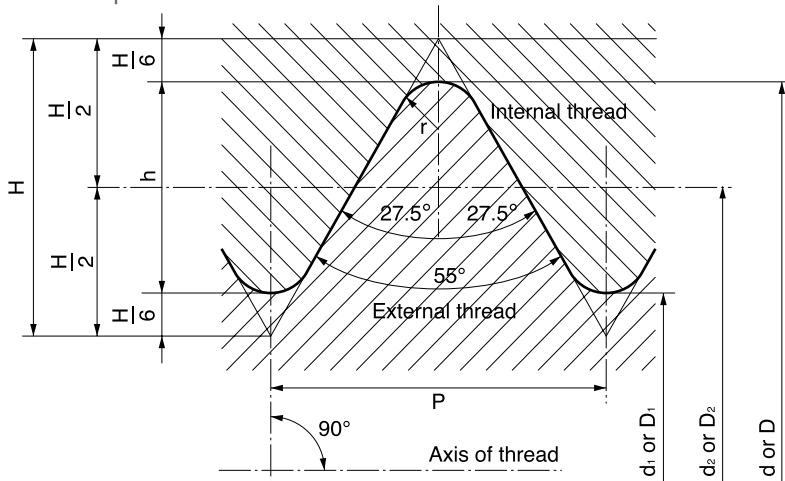

Thick continuous line shows basic profile.

$$P = \frac{25.4}{n}$$

$$H = 0.960491P$$

$$h = 0.640327P$$

$$r = 0.137329P$$

$$d_2 = d - h \quad D_2 = d_2$$

$$d_1 = d - 2h \quad D_1 = d_1$$

$$D = d$$

2. Basic sizes

(Unit:mm)

Designation of thread	Number of threads (per 25.4mm) n	Pitch P	Height of thread h	Radius r	External thread		
					Major dia. d	Pitch dia. d ₂	Minor dia. d ₁
					Internal thread		
					Major dia. D	Pitch dia. D ₂	Minor dia. D ₁
G 1/16	28	0.9071	0.581	0.12	7.723	7.142	6.561
G 1/8	28	0.9071	0.581	0.12	9.728	9.147	8.566
G 1/4	19	1.3368	0.856	0.18	13.157	12.301	11.445
G 3/8	19	1.3368	0.856	0.18	16.662	15.806	14.950
G 1/2	14	1.8143	1.162	0.25	20.955	19.793	18.631
G 5/8	14	1.8143	1.162	0.25	22.911	21.749	20.587
G 3/4	14	1.8143	1.162	0.25	26.441	25.279	24.117
G 7/8	14	1.8143	1.162	0.25	30.201	29.039	27.877
G 1	11	2.3091	1.479	0.32	33.249	31.770	30.291

About thread standard

The above standard is an excerpt from a standard table issued by the Japan Standards Association. For design and trade, be sure to check the appropriate updated standard table.

Taper Pipe Threads (JIS B 0203-1999)

1. Basic profile

Basic profile applied for taper external and taper internal threads.

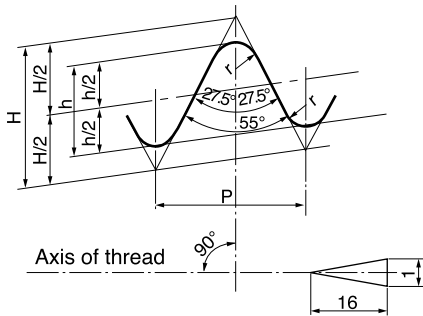

Thick continuous line shows basic profile.

$$P = \frac{25.4}{n} \quad h = 0.640327P$$

$$H = 0.960237P \quad r = 0.137278P$$

Basic profile applied for parallel internal threads.

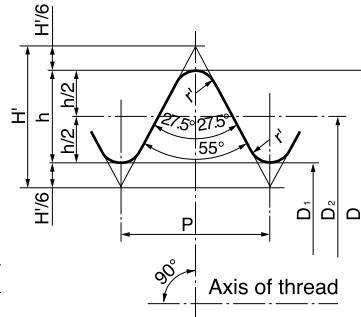

Thick continuous line shows basic profile.

$$P = \frac{25.4}{n} \quad h = 0.640327P$$

$$H' = 0.960491P \quad r' = 0.137329P$$

Fit between taper external thread and taper internal or parallel internal thread

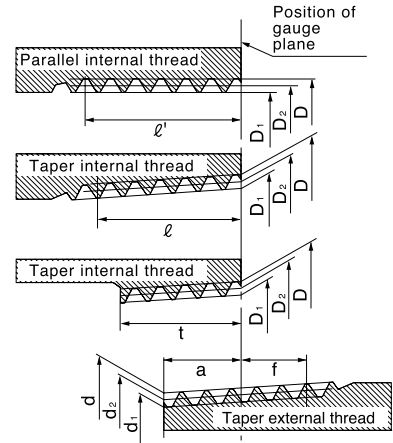

2. Basic size

(Unit:mm)

Designation of thread (PT)	Thread				Gauge dia.			Position of gauge plane			Tolerance on D, D2 and D1 of parallel internal thread	Length of useful thread (min.)			
	Number of threads per 25.4mm n	Pitch P (referential)	Height of thread h	Radius r or r'	External thread			External thread		Internal thread		From position of gauge plane toward larger dia. end f	When there is incomplete thread part		When there is no incomplete thread part Taper internal thread, parallel internal thread
					Major dia. d	Pitch dia. d ₂	Minor dia. d ₁	From pipe end	At pipe end	Taper internal thread			Parallel internal thread		
														Major dia. D	
R1/16	28	0.9071	0.581	0.12	7.723	7.142	6.561	3.97	±0.91	±1.13	±0.071	2.5	6.2	7.4	4.4
R1/8	28	0.9071	0.581	0.12	9.728	9.147	8.566	3.97	±0.91	±1.13	±0.071	2.5	6.2	7.4	4.4
R1/4	19	1.3368	0.856	0.18	13.157	12.301	11.445	6.01	±1.34	±1.67	±0.104	3.7	9.4	11.0	6.7
R3/8	19	1.3368	0.856	0.18	16.662	15.806	14.950	6.35	±1.34	±1.67	±0.104	3.7	9.7	11.4	7.0
R1/2	14	1.8143	1.162	0.25	20.955	19.793	18.631	8.16	±1.81	±2.27	±0.142	5.0	12.7	15.0	9.1
R3/4	14	1.8143	1.162	0.25	26.441	25.279	24.117	9.53	±1.81	±2.27	±0.142	5.0	14.1	16.3	10.2
R1	11	2.3091	1.479	0.32	33.249	31.770	30.291	10.39	±2.31	±2.89	±0.181	6.4	16.2	19.1	11.6

Tube

Clean tube

Processed tube

PushOne fitting

QuickSeal fitting

Clean fitting/Chemit

Bamboo-shoot fitting

Control switch/Detachable series

Jig/Tool/Accessory

Technical information

Reference

Metric Coarse Screw Threads (JIS B 0205-1987)

1. Basic profile

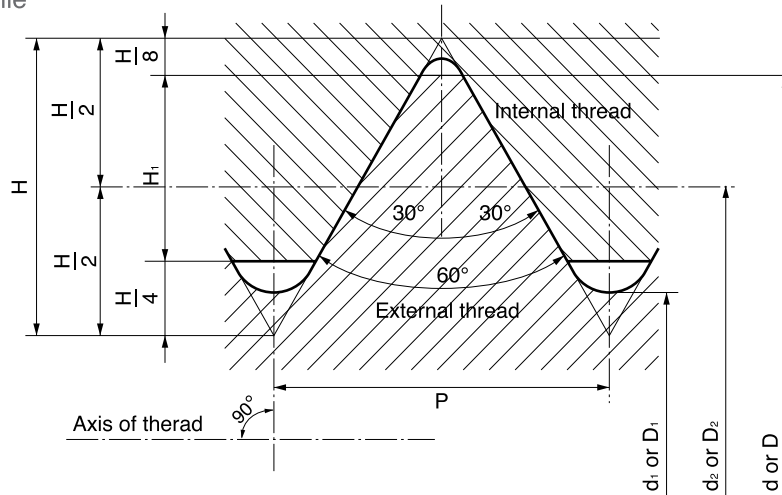

$$H=0.866025P$$

$$H_1=0.541266P$$

$$d_2=d-0.649519P$$

$$d_1=d-1.082532P$$

$$D=d$$

$$D_2=d_2$$

$$D_1=d_1$$

2. Basic sizes

(Unit:mm)

Designation of thread			Pitch	Thread overlap H_1	External thread		
					Major dia. d	Pitch dia. d_2	Minor dia. d_1
Primary	Secondary	Tertiary	P	H_1	Internal thread		
					Major dia. D	Pitch dia. D_2	Minor dia. D_1
M3	M3.5		0.5	0.271	3.000	2.675	2.459
M4			0.6	0.325	3.500	3.110	2.850
M5	M4.5		0.7	0.379	4.000	3.545	3.242
			0.75	0.406	4.500	4.013	3.688
M6			0.8	0.433	5.000	4.480	4.134
M8			1	0.541	6.000	5.350	4.917
M10		M7	1	0.541	7.000	6.350	5.917
		M9	1.25	0.677	8.000	7.188	6.647
M12			1.25	0.677	9.000	8.188	7.647
		M11	1.5	0.812	10.000	9.026	8.376
M16			1.5	0.812	11.000	10.026	9.376
		1.75	0.947	12.000	10.863	10.106	
M20	M14		2	1.083	14.000	12.701	11.835
	M18		2	1.083	16.000	14.701	13.835
M24			2.5	1.353	18.000	16.376	15.294
	2.5		1.353	20.000	18.376	17.294	
M30	M22		2.5	1.353	22.000	20.376	19.294
			3	1.624	24.000	22.051	20.752
	M27		3	1.624	27.000	25.051	23.752
			3.5	1.894	30.000	27.727	26.211

Tube
Clean tube
Processed tube
PushOne fitting
QuickSeal fitting
Clean fitting/ Chemifit
Bamboo-shoot fitting
Control switch/ Detachable series
Jig/Tool/ Accessory
Technical information
Reference

Metric Fine Screw threads (JIS B 0207-1987)

1. Basic profile

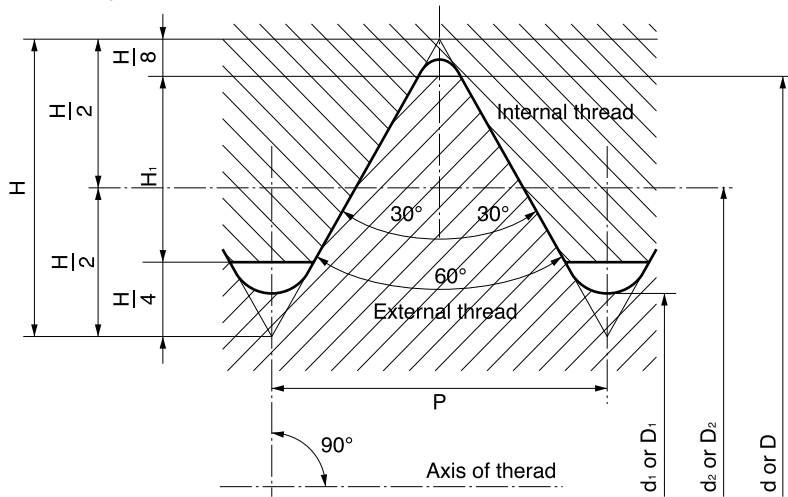

$$H=0.866025P$$

$$H_1=0.541266P$$

$$d_2=d-0.649519P$$

$$d_1=d-1.082532P$$

$$D=d$$

$$D_2=d_2$$

$$D_1=d_1$$

2. Basic sizes

(Unit:mm)

Designation of thread	Pitch P	Thread overlap H_1	External thread		
			Major dia. d	Pitch dia. d_2	Minor dia. d_1
			Internal thread		
			Major dia. D	Pitch dia. D_2	Minor dia. D_1
M3×0.35	0.35	0.189	3.000	2.773	2.621
M3.5×0.35	0.35	0.189	3.500	3.273	3.121
M4×0.5	0.5	0.271	4.000	3.675	3.459
M4.5×0.5	0.5	0.271	4.500	4.175	3.959
M5×0.5	0.5	0.271	5.000	4.675	4.459
M5.5×0.5	0.5	0.271	5.500	5.175	4.959
M6×0.75	0.75	0.406	6.000	5.513	5.188
M7×0.75	0.75	0.406	7.000	6.513	6.188
M8×1	1	0.541	8.000	7.350	6.917
M8×0.75	0.75	0.406	8.000	7.513	7.188
M9×1	1	0.541	9.000	8.350	7.917
M9×0.75	0.75	0.406	9.000	8.513	8.188
M10×1.25	1.25	0.677	10.000	9.188	8.647
M10×1	1	0.541	10.000	9.350	8.917
M10×0.75	0.75	0.406	10.000	9.513	9.188
M11×1	1	0.541	11.000	10.350	9.917
M11×0.75	0.75	0.406	11.000	10.513	10.188
M12×1.5	1.5	0.812	12.000	11.026	10.376
M12×1.25	1.25	0.677	12.000	11.188	10.647
M12×1	1	0.541	12.000	11.350	10.917
M14×1.5	1.5	0.812	14.000	13.026	12.376
M14×1.25	1.25	0.677	14.000	13.188	12.647
M14×1	1	0.541	14.000	13.350	12.917
M15×1.5	1.5	0.812	15.000	14.026	13.376
M15×1	1	0.541	15.000	14.350	13.917
M16×1.5	1.5	0.812	16.000	15.026	14.376
M16×1	1	0.541	16.000	15.350	14.917
M17×1.5	1.5	0.812	17.000	16.026	15.376
M17×1	1	0.541	17.000	16.350	15.917
M18×2	2	1.083	18.000	16.701	15.835
M18×1.5	1.5	0.812	18.000	17.026	16.376
M18×1	1	0.541	18.000	17.350	16.917
M20×2	2	1.083	20.000	18.701	17.835
M20×1.5	1.5	0.812	20.000	19.026	18.376
M20×1	1	0.541	20.000	19.350	18.917
M22×2	2	1.083	22.000	20.701	19.835
M22×1.5	1.5	0.812	22.000	21.026	20.376
M22×1	1	0.541	22.000	21.350	20.917
M24×2	2	1.083	24.000	22.701	21.835
M24×1.5	1.5	0.812	24.000	23.026	22.376
M24×1	1	0.541	24.000	23.350	22.917
M25×2	2	1.083	25.000	23.701	22.835
M25×1.5	1.5	0.812	25.000	24.026	23.376
M25×1	1	0.541	25.000	24.350	23.917
M26×1.5	1.5	0.812	26.000	25.026	24.376
M27×2	2	1.083	27.000	25.701	24.835
M27×1.5	1.5	0.812	27.000	26.026	25.376
M27×1	1	0.541	27.000	26.350	25.917
M28×2	2	1.083	28.000	26.701	25.835
M28×1.5	1.5	0.812	28.000	27.026	26.376
M28×1	1	0.541	28.000	27.350	26.917
M30×3	3	1.624	30.000	28.051	26.752
M30×2	2	1.083	30.000	28.701	27.835
M30×1.5	1.5	0.812	30.000	29.026	28.376
M30×1	1	0.541	30.000	29.350	28.917

Tube

Clean tube

Processed tube

PushOne fitting

QuickSeal fitting

Clean fitting/Chemifit

Bamboo-shoot fitting

Control switch/Detachable series

Jig/Tool/Accessory

Technical information

Reference

UL-94 Standard Flame Test

UL (Underwrite Laboratories Inc.) is a non-profit test organization established in 1894 by an American insurance company to respond to the needs mainly for improving safety of electric and electronic instruments.

Major tasks are various regulations to raw material, parts, unfinished products and finished products, as well as creation, examination, certification and registration of safety test standards. It has a major influence with a world-wide network.

UL-94 standard (Tests for Flammability of Plastic Materials for Parts in Devices and Appliances) is the most fundamental one among several UL standards for plastic materials flammability tests.

UL-94 standard has various test methods and flammability classes. Here we introduce self-extinguishing material classes V-0, V-1 and V-2 from the tests for flammability class of materials such as injection-molding grade, extruded plate and press-molded plate.

The flammability of general nylon and the material of the polyurethane tube are tested by UL-94 HB to examine the combustion velocity.

	94 V-0	94 V-1	94 V-2
Specimen	A set of five specimens processed for 48 hours at 23±2 degrees C and RH50±5%, and a set of five specimens processed for 168 hours at 70±1 degrees C, each of which is 5 inch (127mm) long, 0.5 inch (12.7mm) wide with the maximum thickness under 0.5 inch.		
Test method	<ul style="list-style-type: none"> ● Conduct a test with no draft. ● Prepare a 3/4 inch-high blue burner flame with no yellow tip. ● Apply the adjusted flame to a specimen for 10 seconds and remove. Observe the specimen burning. When the burning stops, reapply the flame for an additional 10 seconds. 		
Requirements	<p>A. The specimens may not burn with flaming combustion for more than 10 seconds after either application of the test flame.</p> <p>B. The total flaming combustion time may not exceed 50 seconds for the 10 flame applications for each set of five specimens.</p> <p>C. The specimens may not burn with flaming or glowing combustion up to the holding clamp.</p> <p>D. The specimens may not drip flaming particles that ignite the surgical cotton located 12 inch below the test specimen.</p> <p>E. The specimens may not have glowing combustion that persists for more than 30 seconds after the second removal of the test flame.</p>	<p>A. The specimens may not burn with flaming combustion for more than 30 seconds after either application of the test flame.</p> <p>B. The total flaming combustion time may not exceed 250 seconds for the 10 flame applications for each set of five specimens.</p> <p>C. The specimens may not burn with flaming or glowing combustion up to the holding clamp.</p> <p>D. The specimens may not drip flaming particles that ignite the surgical cotton located 12 inch below the test specimen.</p> <p>E. The specimens may not have glowing combustion that persists for more than 60 seconds after the second removal of the test flame.</p>	<p>A. The specimens may not burn with flaming combustion for more than 30 seconds after either application of the test flame.</p> <p>B. The total flaming combustion time may not exceed 250 seconds for the 10 flame applications for each set of five specimens.</p> <p>C. The specimens may not burn with flaming or glowing combustion up to the holding clamp.</p> <p>D. The specimens can drip flaming particles that ignite the surgical cotton below the test specimen.</p> <p>E. The specimens may not have glowing combustion that persists for more than 60 seconds after the second removal of the test flame.</p>
	<p>If any one of five specimens does not meet the requirements and if the total flaming combustion time is in the range below (*), test another set of five specimens. The second set has to meet all the requirements.</p> <p style="text-align: center;">*94V-0 51-55 seconds, 94V-1 251-255 seconds, 94V-2 251-255 seconds</p>		

About UL standard





The above is extracted from UL standards as reference.

See the appropriate latest original standards for design and trade.

Table of Full Scale of Tube and Screw

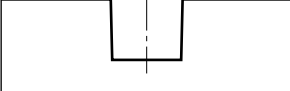
The size of the tube and thread can be easily checked by placing the product on the following full-scale figures.







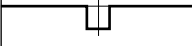
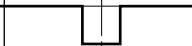
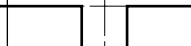







● Taper pipe threads

Thread size	R1/8	R1/4	R3/8	R1/2
Full scale				

● Metric threads

Thread size	M3×0.5	M5×0.8	M6×1.0
Full scale			

● Tube (outer diameter)

Millimeter size	φ3	—	φ3.5	φ4	—
Inch size	—	1/8 (φ3.18)	—	—	3/16 (φ4.76)
Full scale					
Millimeter size	φ6	—	—	φ8	—
Inch size	—	1/4 (φ6.35)	5/16 (φ7.94)	—	3/8 (φ9.53)
Full scale					
Millimeter size	φ10	φ12	—	—	φ16
Inch size	—	—	1/2 (φ12.70)	5/8 (φ15.88)	—
Full scale					

Tube

Clean tube

Processed tube

PushOne fitting

QuickSeal fitting

Clean fitting/Chemifit

Bamboo-shoot fitting

Control switch/Detachable series

Jig/Tool/Accessory

Technical information

Reference

Unit Conversion Table

Length

m	inch	foot	yard	mile
1	3.937×10	3.2808	1.0936	6.2×10 ⁻⁴
2.54×10 ⁻²	1	8.3333×10 ⁻²	2.778×10 ⁻²	1.6×10 ⁻⁵
3.048×10 ⁻¹	1.2×10	1	3.3333×10 ⁻¹	1.9×10 ⁻⁴
9.114×10 ⁻¹	3.6×10	3	1	5.7×10 ⁻⁴
1.6093×10 ³	6.3360×10 ⁴	5.280×10 ³	1.760×10 ³	1

Weight

kg	ton(●)	ton(●)	lb	Ounce
1	9.842×10 ⁻⁴	1.1023×10 ⁻³	2.2046	3.5274×10
1.016×10 ³	1	1.12	2.240×10 ³	3.5838×10 ⁴
9.072×10 ²	8.9286×10 ⁻¹	1	2×10 ³	3.2×10 ⁴
4.536×10 ⁻¹	4.464×10 ⁻⁴	5×10 ⁻⁴	1	1.6×10
2.835×10 ⁻²	2.79×10 ⁻⁵	3.13×10 ⁻⁵	6.25×10 ⁻²	1

Pressure

Pa	MPa	bar	kgf/cm ²	psi	mmHg
1	1×10 ⁻⁶	1×10 ⁻⁵	1.0197×10 ⁻⁵	1.4504×10 ⁻⁴	7.5006×10 ⁻³
1×10 ⁵	1×10 ⁻¹	1	1.0197	1.4504×10	7.5006×10 ²
9.8067×10 ⁴	9.8067×10 ⁻²	9.8067×10 ⁻¹	1	1.4223×10	7.3556×10 ²
6.8948×10 ³	6.8948×10 ⁻³	6.4898×10 ⁻²	7.0307×10 ⁻²	1	5.1715×10
1.3332×10 ²	1.3332×10 ⁻⁴	1.332×10 ⁻³	1.3595×10 ⁻³	1.934 ¹ ×10 ⁻²	1

Force

N	dyn	kgf
1	1×10 ⁵	1.0197×10 ⁻¹
1×10 ⁻⁵	1	1.0197×10 ⁻⁶
9.8066	9.8066×10 ⁵	1

* Å† presents SI units.

Tube

Clean tube

Processed tube

PushOne fitting

QuickSeal fitting

Clean fitting/Chemifit

Bamboo-shoot fitting

Control switch/Detachable series

Jig/Tool/Accessory

Technical information

Reference

Chemical Resistance Specification Table (alphabetical order)

[How to read the table]

- The table shows chemical resistance of materials, not of Nitta's products (finished products). Therefore the table does not guarantee the chemical resistance performance of the products.
- The table is created under certain conditions. The symbol [○] does not always mean chemical resistance depending on the environment, condition, and duration of use. Be sure to check under the actual conditions of use.
- Test is conducted for saturated solutions of chemicals in the table at a room temperature unless specifically indicated.
- The table does not present permeability for gas chemicals. Chemicals that are toxic when permeating, such as activated gas, cannot be used for Nitta's products.
- Contact us for chemical resistance of plated and seal processed parts.

[Contact us]

Before contact us, check 1. the maximum working pressure, 2. working temperature range, 3. chemical concentration, 4. piping state (environmental state), and 5. use application, and then contact us or our regional office.

[Criteria]

- : Can be used with no influence, or almost no influence on material
- △: Can be used although having influence to a certain degree on material. Sufficient check is required.
- ×: Cannot be used.
- : No data.

Chemical Resistance Specification Table (for reference)

Test is conducted for saturated solutions of chemicals in the table at a room temperature unless specifically indicated.

Chemical (weight concentration %, temperature °C)	Tube material				Fitting material				Seal material			
	Polyurethane	Nylon	Polyolefin	Fluorocarbon resin	Brass	SUS304	SUS316	PBT	PP	NBR	EPDM	FKM
2-Aminophenyl Disulfide	△	○	○	—	—	—	—	—	—	—	—	—
Acetaldehyde	×	△	×	×	○	○	○	△	△	×	△	×
Acetic Acid (10%,20°C)	×	△	○	○	×	△	○	△	○	×	—	—
Acetic Acid (50%,20°C)	×	×	△	○	×	△	△	△	×	×	—	△
Acetic Acid (50%,70°C)	×	×	×	○	×	△	△	△	×	×	—	△
Acetic Acid (100%,20°C)	×	×	×	○	×	△	△	△	×	×	—	△
Acetic Anhydride	×	×	△	○	×	△	△	—	△	×	△	×
Acetoamide	—	—	×	○	—	—	—	△	△	○	○	△
Acetone	×	△	△	○	○	△	△	△	×	×	△	×
Acetyl Bromide	×	×	×	○	—	—	—	—	—	×	○	○
Acetyl Chloride	×	×	×	—	—	—	△	—	—	—	—	—
Acetylene	○	○	○	○	×	○	○	○	○	○	○	○
Acrylonitrile	—	—	△	○	△	△	△	△	—	×	—	×
Alum	—	×	○	○	—	—	—	—	○	○	—	—
Aluminium Acetate	—	○	○	○	—	—	—	△	○	△	○	×
Aluminium Bromide	—	△	○	○	—	—	—	—	○	○	○	○
Aluminium Chloride	—	△	○	○	×	×	×	△	○	○	○	○
Aluminium Fluoride	—	△	○	○	○	×	×	—	○	○	○	○
Aluminium Nitrate	△	△	○	○	—	—	△	△	○	○	○	○
Aluminium Sulfate	—	○	○	○	×	○	○	△	○	○	○	○
Ammonia Anhydrous	—	○	○	○	×	○	○	△	○	○	○	×
Ammonia Gas Cold	×	×	×	×	×	○	○	△	—	○	○	×
Ammonia Gas Hot	×	×	×	×	×	△	△	×	—	△	○	×
Ammonia Liquid	—	○	○	○	△	○	○	△	△	△	—	—
Ammonia Water	△	△	○	○	×	△	△	△	—	—	—	—
Ammonium Carbonate	—	○	○	○	—	△	△	△	○	×	○	○
Ammonium Chloride	○	○	○	○	×	△	△	△	○	○	○	○
Ammonium Hydroxide	△	△	○	○	×	△	△	×	○	×	○	○
Ammonium Nitrate	○	○	○	○	×	△	△	△	○	○	○	—
Ammonium Persulphate	—	○	○	○	—	—	—	—	—	—	—	—
Ammonium Phosphate	○	○	○	○	△	△	△	△	○	○	—	—
Ammonium Sulfate	○	○	○	○	△	△	△	△	○	○	○	×
Amyl Acetate	×	○	×	○	△	—	○	△	×	×	△	×
Amyl Alcohol	△	△	△	△	△	—	—	△	△	△	○	○
Amyl Borate	—	—	△	○	—	—	—	—	△	○	×	○

Tube

Clean tube

Processed tube

PushOne fitting

QuickSeal fitting

Clean fitting/Chemifit

Bamboo-shoot fitting

Control switch/Detachable series

Jig/Tool/Accessory

Technical information

Reference

Chemical Resistance Specification Table (for reference)

Test is conducted for saturated solutions of chemicals in the table at a room temperature unless specifically indicated.

	Chemical (weight concentration %, temperature °C)	Tube material				Fitting material					Seal material		
		Polyurethane	Nylon	Polyolefin	Fluorocarbon resin	Brass	SUS304	SUS316	PBT	PP	NBR	EPDM	FKM
A	Amyl Naphthalene	—	—	△	○	—	—	—	○	△	×	—	—
	Anethole	—	○	—	○	—	—	—	—	—	—	—	—
	Aniline	×	×	×	○	×	△	△	△	×	×	△	△
	Aniline Dyes	—	×	○	○	—	—	—	△	○	×	△	△
	Animal Oil (Lard Oil)	○	○	○	○	○	—	△	○	○	△	○	○
	Aqua Regia	×	×	×	○	—	—	—	×	×	×	△	○
	Arsenic Acid	—	△	○	○	△	△	△	—	○	—	—	—
	Asphalt	○	○	○	○	○	○	○	—	○	○	×	○
	ASTM Lubricant No.1	○	○	×	○	○	○	○	○	△	○	×	○
	ASTM Lubricant No.2	×	○	×	○	○	○	○	○	△	○	×	○
	ASTM Lubricant No.3	×	○	×	○	○	○	○	○	△	△	×	○
	ASTM Standard Fuel Oil A	○	○	×	○	○	○	○	○	△	○	×	○
	ASTM Standard Fuel Oil B	○	○	×	○	○	○	○	○	△	○	×	○
	ASTM Standard Fuel Oil C	○	○	×	○	○	○	○	○	△	○	×	○
B	Balium Hydroxide	—	○	○	○	×	—	○	△	○	○	○	○
	Barium Chloride	○	○	○	○	×	—	△	△	○	○	○	○
	Barium Sulfate	—	○	○	○	△	△	△	△	○	○	○	○
	Barium Sulfide	—	○	○	○	—	—	△	△	○	○	○	○
	Beet Sugar Oil	—	○	○	○	×	—	○	—	○	○	—	—
	Benzaldehyde	△	△	×	○	△	△	△	—	×	×	—	×
	Benzene	×	△	×	○	×	△	△	△	×	×	×	△
	Benzine	△	△	×	○	—	—	—	△	×	○	—	○
	Benzoic Acid	×	○	○	○	△	△	△	△	—	—	—	—
	Benzyl Alcohol	△	△	△	○	△	△	△	△	—	×	○	○
	Benzyl Benzoate	—	—	—	○	—	—	—	△	—	×	×	○
	Benzyl Chloride	—	×	—	○	—	—	×	—	—	×	×	○
	Borax	○	○	○	○	×	—	○	—	○	△	○	○
	Boric Acid	○	○	○	○	△	△	△	△	○	○	○	○
	Bromine	×	×	×	○	×	—	×	×	—	×	×	○
	Bunker Fuel	—	○	—	○	△	—	○	—	—	○	—	—
	Buthane	—	○	△	○	○	○	○	○	○	○	×	○
	Butyl Acetate	×	○	×	○	△	—	△	△	×	×	△	×
	Butyl Acrylate	—	○	×	○	—	—	—	△	△	×	—	×
	Butyl Alcohol	△	△	△	○	○	○	○	△	—	△	△	○
	Butyl Cellosolve	—	△	—	—	△	—	△	○	—	△	—	—
	Butyl Stearate	—	○	—	○	—	—	—	△	—	△	×	○
C	Calcium Acetate	○	○	○	○	△	—	△	△	○	○	○	×
	Calcium Arsenate	○	○	○	—	—	—	—	△	—	△	○	△
	Calcium Bisulfite	○	○	○	○	×	—	△	△	—	—	—	—
	Calcium Chloride	○	○	○	○	○	△	△	△	○	○	○	○
	Calcium Hydroxide	△	○	○	○	△	△	△	×	○	○	○	○
	Calcium Hypochlorite (20%,20°C)	×	×	○	○	×	—	△	△	○	—	—	—
	Calcium Nitrate	—	○	○	○	—	—	—	△	○	○	○	○
	Calcium Sulfide	—	○	○	○	—	—	△	△	○	○	○	○
	Cane Sugar Liquors	—	○	○	○	○	—	○	○	○	○	○	—
	Carbitol	—	—	△	—	△	—	△	—	—	○	—	—
	Carbon Dioxide	○	○	○	○	○	○	○	○	○	○	—	—
	Carbon Disulfide	×	×	×	○	○	○	○	—	×	△	×	○
	Carbon Oxide	○	○	○	○	○	○	○	△	—	○	○	○
	Carbon Tetrachloride	×	×	×	△	△	△	△	×	×	×	×	○
	Carbonic Acid	△	○	△	○	○	△	△	—	△	△	○	○
	Castor Oil	△	○	○	○	○	△	△	△	—	○	△	○
	Cellosolve	—	○	○	○	△	—	△	○	×	○	×	×
	Cellosolve Acetate	×	△	—	—	—	—	—	△	—	×	○	×
	Chloride Gas (dry)	×	×	×	△	△	×	×	×	×	△	×	○
	Chloride Gas (wet)	×	×	×	△	×	×	×	×	×	×	×	△
	Chloro Acetone	—	—	×	—	—	—	—	—	×	×	○	×
	Chloroform	×	△	×	○	△	△	△	△	×	×	×	○
	Chlorosulfonic Acid	—	×	×	○	△	×	×	△	×	×	×	×
	Chlorotoluene	—	×	×	○	—	—	—	△	×	×	×	○

Chemical Resistance Specification Table (for reference)

Test is conducted for saturated solutions of chemicals in the table at a room temperature unless specifically indicated.

	Chemical (weight concentration %, temperature °C)	Tube material				Fitting material				Seal material				
		Polyurethane	Nylon	Polyolefin	Fluorocarbon resin	Brass	SUS304	SUS316	PBT	PP	NBR	EPDM	FKM	
C	Chromic Acid (2%,50°C)	X	X	X	○	X	X	△	△	—	—	—	—	
	Chromic Acid (2%,70°C)	X	X	X	○	X	X	△	X	△	X	○	○	
	Chromic Acid (10%,70°C)	X	X	X	○	X	X	△	X	X	X	—	○	
	Chromic Acid (25%,70°C)	X	X	X	△	X	X	△	X	X	X	X	○	
	Citric Acid	△	○	○	○	△	△	△	X	○	○	○	○	
	Coal-Tar	○	○	△	○	△	○	○	—	△	○	—	—	
	Copper Chloride	○	△	○	○	X	X	X	△	—	○	○	○	
	Copper Cyanide	—	○	○	○	—	—	○	△	○	○	○	○	
	Copper Sulfate	○	○	○	○	○	△	○	△	○	○	○	○	
	Corn Oil	○	○	△	○	X	—	○	○	○	○	—	—	
	Cotton Seed Oil	○	○	△	○	△	△	△	—	△	○	△	○	
	Creosote	X	X	△	○	△	△	△	—	—	○	—	○	
	Cresol	X	X	X	○	△	△	○	△	△	X	X	○	
	Cyclohexane	△	○	X	○	△	—	△	○	X	○	X	○	
	Cyclohexanol	—	○	△	○	△	△	△	△	△	△	X	○	
	Cyclohexanone	X	○	X	○	—	—	—	△	X	X	△	X	
	Decalin	—	○	△	○	—	—	—	—	—	X	X	○	
	Developer	△	△	○	○	—	—	—	△	○	○	△	○	
	Diacetone Alcohol	△	○	○	○	△	○	○	—	—	X	○	X	
	D	Dibenzine Ether	X	△	X	△	○	—	○	—	X	X	△	X
Dibutyl Ether		△	△	X	○	—	—	—	△	X	X	X	△	
Dibutyl Phthalate		△	○	△	○	—	—	—	△	△	X	○	△	
Dichlorobenzene		X	△	X	○	△	—	—	△	X	X	X	○	
Diethanol Amine		△	○	—	—	—	—	○	△	—	—	—	—	
Diethyl Ether		△	△	△	○	△	—	△	△	—	X	X	X	
Diethyl Sebacate		—	△	X	○	—	—	—	△	X	△	△	△	
Diisopropyl Ketone		X	△	△	○	—	—	—	△	X	X	—	—	
Dimethyl Formamide		X	X	△	△	△	—	—	△	X	X	X	X	
Dinitrogen Oxide (Nitrous Oxide)		X	○	X	○	X	△	○	△	—	—	—	—	
Diethyl Phthalate (DOP)		△	○	X	○	—	—	—	△	△	○	○	○	
Diethyl Sebacate (DOS)		△	○	X	○	—	—	—	○	△	X	—	△	
Dipentene (Limonene)		X	△	X	○	—	—	—	—	—	△	X	○	
Diphenyl		X	△	X	○	—	—	—	△	—	X	X	○	
Diphenyl Oxide		—	—	—	○	—	—	—	—	—	X	X	○	
Dowtherm(100°C)		—	—	—	○	—	—	—	—	—	X	—	○	
Dowtherm(200°C)		—	—	—	○	—	—	—	—	—	—	—	—	
E		Epichlorohydrin	—	X	—	○	—	—	—	—	—	X	△	X
		Ester Silicate	—	○	—	○	—	—	—	△	—	○	—	—
		Ethanol Amine	—	X	X	○	—	—	—	△	△	○	○	X
	Ethyl Acetate	X	○	△	○	△	△	△	△	X	X	△	X	
	Ethyl Acetoacetate	—	—	—	○	—	—	—	△	—	X	△	X	
	Ethyl Acrylate	X	—	—	△	△	—	—	△	—	X	—	X	
	Ethyl Alcohol	X	△	△	○	○	△	○	△	△	○	○	○	
	Ethyl Benzene	—	—	X	○	△	○	○	△	X	X	X	○	
	Ethyl Cellulose	—	—	○	○	—	—	△	○	○	○	○	X	
	Ethyl Chloride	X	○	X	—	△	○	○	—	X	○	△	○	
	Ethyl Ether (>Diethyl Ether)	△	△	△	○	△	○	○	△	—	—	—	—	
	Ethyl Oxalate	X	○	X	○	—	—	—	△	—	X	○	△	
	Ethyl Silicate	—	△	—	○	—	—	—	△	—	○	○	○	
	Ethylene Chlorohydrin	X	X	X	○	—	—	—	—	X	X	△	△	
	Ethylene Diamine	—	X	X	○	—	—	—	△	△	○	○	X	
	Ethylene Dichloride	X	X	△	○	○	△	△	X	—	X	—	○	
	Ethylene Glycol	○	○	○	○	△	△	△	△	△	○	○	○	
	Ethylene Oxide	X	○	X	○	△	—	△	△	○	X	—	X	
	F	Fatty Acids	△	○	X	○	△	△	○	△	X	△	X	○
		Ferric Chloride	—	△	○	○	X	X	X	△	○	○	○	○
Ferric Nitrate		—	○	○	○	—	—	—	△	○	○	○	○	
Ferric Sulfate		○	○	○	○	X	△	△	△	○	○	○	○	
Fluorine		X	—	X	X	X	—	△	—	—	—	—	—	
Fluoroboric Acid		X	—	○	○	—	—	○	—	○	△	—	—	

Tube

Clean tube

Processed tube

PushOne fitting

QuickSeal fitting

Clean fitting/Chemifit

Bamboo-shoot fitting

Control switch/Detachable series

Jig/Tool/Accessory

Technical information

Reference

Chemical Resistance Specification Table (for reference)

Test is conducted for saturated solutions of chemicals in the table at a room temperature unless specifically indicated.

	Chemical (weight concentration %, temperature °C)	Tube material				Fitting material					Seal material		
		Polyurethane	Nylon	Polyolefin	Fluorocarbon resin	Brass	SUS304	SUS316	PBT	PP	NBR	EPDM	FKM
F	Formaldehyde (40%,20°C)	X	X	△	○	△	△	△	—	○	X	△	○
	Formic Acid (25%,20°C)	X	X	○	○	X	△	○	△	○	X	○	X
	Formic Acid (50%,20°C)	X	X	○	○	X	△	○	—	○	X	—	—
	Formic Acid (90%,20°C)	X	X	△	○	X	△	○	—	○	X	—	—
	Freon 11	—	△	—	△	○	○	○	○	—	○	—	△
	Freon 12	—	△	—	△	○	○	○	○	—	△	—	○
	Freon 21	—	△	—	△	○	○	○	○	—	X	—	—
	Freon 22	—	△	—	△	○	○	○	○	—	X	—	X
	Freon 113	—	△	—	△	○	○	○	○	—	○	—	○
	Freon 114	—	△	—	△	○	○	○	○	—	—	—	—
G	Furan	—	X	—	△	—	—	—	△	—	X	X	○
	Furfural	X	X	X	○	△	△	△	△	X	X	○	X
	Furfuryl Alcohol	○	○	○	—	—	—	—	—	—	—	—	—
	Gasoline	X	○	△	○	○	○	○	○	△	○	X	○
	Gelatine	○	○	○	○	○	○	○	△	○	○	○	○
	Glucose	○	○	○	○	○	○	○	○	○	○	—	—
	Glue	—	○	○	○	△	—	△	—	○	○	—	—
	Glycerine	△	○	○	○	△	○	○	○	○	○	○	○
	Grease	△	○	△	○	△	○	○	○	X	—	—	—
	H	Heavy Water	○	○	○	○	—	—	—	△	—	○	○
Heptane		○	○	X	—	○	○	○	△	—	○	X	○
Hexane		△	○	X	○	△	△	△	○	X	○	X	○
Hexyl Alcohol		—	△	△	○	—	—	—	△	△	○	X	○
Hydrazine		—	△	△	△	—	—	—	—	—	△	○	X
Hydrobromic Acid (20%,20°C)		—	△	○	○	X	X	X	△	○	X	○	○
Hydrobromic Acid (20%,70°C)		—	X	△	○	X	X	X	△	○	—	—	—
Hydrobromic Acid (37%,20°C)		—	△	○	○	X	X	X	△	○	○	—	—
Hydrochloric Acid (10%,20°C)		X	△	○	○	X	X	X	△	○	○	○	○
Hydrochloric Acid (20%,20°C)		X	X	△	○	X	X	X	X	○	△	○	○
Hydrochloric Acid (20%,80°C)	X	X	X	○	X	X	X	X	△	X	○	○	
Hydrochloric Acid (38%,20°C)	X	X	○	○	X	X	X	X	○	X	△	○	
Hydrocyanic Acid	—	X	○	○	X	—	○	△	○	△	○	○	
Hydrofluoric Acid (10%,20°C)	X	X	△	○	△	X	X	△	○	X	—	—	
Hydrofluoric Acid (20%,20°C)	X	X	△	○	△	X	X	△	○	X	—	—	
Hydrofluoric Acid (40%,20°C)	X	X	△	○	△	X	X	△	○	X	—	—	
Hydrofluoric Acid (Anhydrous)	X	X	X	○	X	—	X	—	X	—	—	—	
Hydrogen	○	○	○	○	△	○	○	○	○	○	○	○	
Hydrogen Peroxide (5%,20°C)	△	○	○	○	X	△	△	△	○	X	○	○	
Hydrogen Peroxide (5%,50°C)	X	△	△	○	X	△	△	—	○	X	△	○	
Hydrogen Peroxide (30%,20°C)	X	X	△	○	X	△	△	—	○	X	X	○	
Hydrogen Sulfide	—	△	○	○	△	△	△	△	○	X	○	X	
Hydroquinone	—	○	○	○	—	—	—	—	○	—	—	—	
Hypochlorous Acid	X	△	○	○	—	—	—	△	○	—	—	—	
I	Isobutyl Alcohol	—	△	○	○	—	—	—	△	○	△	○	○
	Isocyanates	○	○	○	○	—	—	—	—	—	—	—	—
	Isooctane	X	○	X	○	○	△	△	○	—	○	X	○
	Isopropyl Acetate	△	○	X	○	○	—	△	△	X	X	—	—
	Isopropyl Alcohol	—	△	○	○	△	△	△	△	○	△	○	○
	Isopropyl Ether	—	△	△	○	○	△	△	△	△	○	—	—
J	JP Fuel Oil	△	△	X	○	○	○	—	△	—	—	—	
K	Kerosene	○	○	△	○	○	○	○	○	X	○	X	○
	Ketones	△	○	○	○	△	△	△	△	—	—	—	—
L	Lacquer	△	△	△	○	—	—	—	△	X	X	X	X
	Lactic Acid	—	△	△	○	X	△	△	△	○	○	○	○
	Lard	○	○	○	○	○	—	△	○	○	○	—	○
	Lead Acetate	—	○	○	○	—	△	—	△	○	△	○	X
	Lead Arsenate	○	○	○	—	—	—	—	—	—	△	○	△
	Lead Nitrate	—	○	○	○	—	—	—	△	○	○	○	—
	Lead Sulfamate	—	○	○	○	—	—	—	△	○	△	○	△
	Lead Sulfate	○	○	○	—	△	—	△	△	—	—	—	—

Chemical Resistance Specification Table (for reference)

Test is conducted for saturated solutions of chemicals in the table at a room temperature unless specifically indicated.

	Chemical (weight concentration %, temperature °C)	Tube material				Fitting material				Seal material			
		Polyurethane	Nylon	Polyolefin	Fluorocarbon resin	Brass	SUS304	SUS316	PBT	PP	NBR	EPDM	FKM
L	Linoleic Acid	—	△	△	○	—	—	—	—	○	△	—	—
	Linseed Oil	○	○	×	○	—	—	—	—	—	○	△	○
	Liquid Chloride	×	×	×	△	—	—	—	×	×	×	×	△
	Liquidified Petroleum Gas	—	○	△	○	○	○	○	○	—	○	—	—
	Lubricant (Ether type)	×	△	×	○	○	○	○	△	—	—	—	—
	Lubricant (Mineral Oil type)	○	○	×	○	○	○	○	△	—	×	○	○
	Lye Solutions	—	○	○	○	—	—	—	△	—	△	○	○
M	Magnesium Chloride	○	○	○	○	×	×	×	△	○	○	○	○
	Magnesium Hydroxide	△	○	○	○	△	—	△	×	○	△	○	○
	Magnesium Sulfate	○	○	○	○	△	○	○	△	○	○	—	—
	Maleic Acid	△	○	○	○	—	△	△	—	○	×	×	○
	Malic Acid	—	○	○	○	△	△	△	△	○	○	△	○
	Mercaptane	—	—	×	○	—	—	—	—	—	○	×	○
	Mercuric Chloride	○	○	○	○	×	×	×	—	○	○	—	—
	Mercury	—	○	○	○	×	—	△	—	○	○	○	—
	Methane	○	○	○	○	○	—	△	○	—	○	×	○
	Methyl Acetate	×	○	△	○	○	—	○	△	×	×	△	×
	Methyl Alcohol	×	△	△	○	○	△	△	△	△	△	○	△
	Methyl Bromide	×	△	×	○	○	—	○	△	—	△	×	○
	Methyl Chloride	×	×	×	○	△	○	○	—	×	×	×	○
	Methyl Ethyl Ketone	×	△	△	○	○	△	△	△	×	×	△	×
	Methyl Isobutyl Ketone	×	△	△	○	△	—	△	△	×	×	△	×
	Methyl Metacrylate	—	○	×	○	—	—	—	△	×	×	×	×
	Methyl Sulfate	×	△	×	—	—	—	—	△	—	—	—	—
	Methylene Dichloride	×	×	△	○	—	—	—	×	×	×	×	△
	Mineral Oils	○	○	△	○	○	○	○	○	△	○	×	△
	Monochloro Benzene	×	×	×	○	—	—	—	—	×	×	×	○
	Monochloroacetic Acid	×	×	×	○	—	—	—	△	△	×	—	—
	Monoethanol Amine	—	○	△	○	—	—	—	—	○	×	—	—
N	n-Hexa Aldehyde	—	—	×	○	—	—	—	—	—	×	—	—
	Naphtha	△	○	×	○	△	△	△	△	△	×	×	○
	Naphthalene	△	○	△	○	△	—	△	△	○	×	×	○
	Naphthenic Acid	—	—	○	○	—	—	—	△	○	△	×	○
	Natural Gas	—	○	○	○	○	○	○	○	○	○	×	○
	Nickel Acetate	—	○	○	○	—	—	△	△	○	△	○	×
	Nickel Chloride	—	×	○	○	×	—	×	—	○	○	○	○
	Nickel Sulfate	—	○	○	○	—	△	△	△	○	○	○	○
	Nitric Acid (10%,20°C)	×	×	○	○	×	△	○	×	○	×	○	○
	Nitric Acid (10%,70°C)	×	×	△	○	×	△	○	×	△	×	△	○
	Nitric Acid (30%,20°C)	×	×	△	○	×	△	○	×	○	×	△	○
	Nitric Acid (30%,70°C)	×	×	×	○	×	△	○	×	△	×	×	○
	Nitric Acid (61%,20°C)	×	×	×	○	×	△	○	×	×	×	×	○
	Nitric Acid (fuming,20°C)	×	×	×	○	×	△	○	×	×	×	×	△
	Nitrobenzene	×	×	×	○	△	△	△	—	×	×	△	△
	Nitroethane	—	—	×	○	—	—	—	—	×	×	△	×
	Nitrogen	○	○	○	○	○	○	○	○	○	○	○	○
	Nitromethane	—	—	×	○	—	—	—	—	×	×	△	×
	Nitropropane	—	—	×	○	—	—	—	—	×	×	—	×
O	Octyl Alcohol	—	×	△	○	△	—	△	△	○	△	△	○
	Oleic Acid	△	○	△	○	△	△	△	○	△	○	×	○
	Olive Oil	○	○	○	○	△	○	○	○	△	○	△	○
	Oxalic Acid	△	○	○	○	×	×	×	△	○	△	○	○
	Oxygene	△	△	△	○	○	○	○	△	○	△	○	○
	Ozone	△	△	△	○	△	△	○	○	—	×	○	○
P	Palm Oil	—	○	△	○	△	—	△	—	○	—	△	—
	Palmitic Acid	○	○	○	○	△	△	△	△	○	○	—	—
	Pentane	○	○	×	—	△	—	△	△	—	—	—	—
	Perchloric Acid	×	×	△	○	×	×	×	△	×	×	○	○
	Perchloroethylene	×	×	×	○	△	—	△	×	×	△	×	○
	Petroleum	○	○	×	○	—	—	—	△	△	○	×	○

Tube

Clean tube

Processed tube

PushOne fitting

QuickSeal fitting

Clean fitting/Chemifit

Bamboo-shoot fitting

Control switch/Detachable series

Jig/Tool/Accessory

Technical information

Reference

Chemical Resistance Specification Table (for reference)

Test is conducted for saturated solutions of chemicals in the table at a room temperature unless specifically indicated.

Chemical (weight concentration %, temperature °C)	Tube material				Fitting material				Seal material				
	Polyurethane	Nylon	Polyolefin	Fluorocarbon resin	Brass	SUS304	SUS316	PBT	PP	NBR	EPDM	FKM	
P	Phenol	X	X	△	○	△	△	△	△	—	X	○	○
	Phenyl Disulfide	△	○	X	—	—	—	—	—	—	—	—	—
	Phenyl Hydrazine	—	—	—	○	—	—	—	—	—	X	△	○
	Phorone	—	—	—	○	—	—	—	—	—	X	—	—
	Phosphoric Acid (50%,20°C)	X	△	○	○	X	△	△	△	○	X	—	—
	Phosphoric Acid (50%,70°C)	X	X	○	○	X	△	X	△	○	X	—	—
	Phosphoric Acid (75%,20°C)	X	X	○	○	X	△	△	△	○	X	—	—
	Phosphorobenzene	△	○	○	—	△	—	△	—	—	—	—	—
	Picking Solution (Nitric Acid 20%/Fluoric Acid 4%)	—	X	○	○	—	—	—	△	○	X	—	—
	Picking Solution (Nitric Acid 40%/Fluoric Acid 15%)	—	X	○	○	—	—	—	△	○	△	—	—
	Picric Acid	X	X	△	○	X	△	△	△	△	△	○	○
	Pine Oil	—	X	X	○	△	△	○	△	△	○	—	—
	Pinene	—	○	X	○	—	—	—	—	—	○	—	—
	Piperidine	—	△	△	○	—	—	—	—	—	X	X	X
	Potassium Bichromate	△	△	○	○	X	—	△	△	○	△	○	△
	Potassium Chloride	○	○	○	○	△	△	○	△	○	○	○	○
	Potassium Cyanide	—	○	○	○	X	△	△	—	○	○	—	—
	Potassium Hydroxide	△	△	○	○	△	△	△	X	○	○	○	X
	Potassium Nitrate	○	△	○	○	△	△	△	△	○	○	○	○
	Potassium Permanganate (5%,20°C)	X	X	△	○	△	△	△	△	○	X	○	X
	Potassium Sulfate	○	○	○	○	△	△	△	△	○	○	○	○
	Propane	△	○	○	○	○	○	○	○	○	○	X	○
	Propyl Acetate	X	○	X	○	○	—	○	△	X	X	△	X
	Propyl Alcohol	X	△	△	○	△	○	○	△	△	△	○	○
	Propylene	—	○	—	○	○	○	○	○	—	△	X	○
	Pyridine	△	X	○	○	△	—	△	△	—	X	—	X
	Pyrrole	—	—	△	○	—	—	—	—	—	X	X	X
S	Salicylic Acid	—	—	○	○	○	△	△	△	○	△	○	○
	Salt Water	—	○	○	○	X	△	△	△	○	○	—	○
	Sea Water	○	○	○	○	△	○	○	△	—	○	○	○
	Silicone Grease	—	○	△	○	—	—	—	○	△	○	○	○
	Silicone Oil	—	○	△	○	—	—	—	○	△	○	○	○
	Silver Nitrate	—	△	○	○	—	—	—	△	○	△	○	○
	Soap aqueous solution	○	○	△	○	○	○	○	△	○	○	○	○
	Soda Water	○	○	○	○	—	—	—	△	—	—	—	—
	Sodium Bicarbonate	○	○	○	○	X	—	△	△	○	○	—	○
	Sodium Bisulphate	○	○	○	○	—	—	—	△	○	○	—	—
	Sodium Carbonate	○	○	○	○	○	△	△	△	—	○	○	○
	Sodium Carbonate	○	○	○	○	X	—	△	△	○	○	○	—
	Sodium Hydroxide (10%,20°C)	X	○	○	○	△	△	△	△	○	○	○	—
	Sodium Hydroxide (30%,20°C)	X	○	○	○	—	—	—	X	○	○	○	X
	Sodium Hydroxide (30%,70°C)	X	X	X	○	—	—	—	X	○	○	○	X
	Sodium Hypochlorite (5%,20°C)	X	X	○	○	X	X	△	△	○	X	○	○
	Sodium Hypochlorite (5%,70°C)	X	X	△	○	X	X	△	△	○	X	△	○
	Sodium Metaphosphate	—	○	○	○	—	—	△	△	○	○	○	○
	Sodium Nitrate	○	○	○	○	△	○	○	△	○	○	—	—
	Sodium Perborate	—	○	○	○	X	—	△	△	○	△	○	○
	Sodium Peroxide	—	X	○	X	X	—	△	—	○	△	○	○
	Sodium Phosphate	○	○	○	○	—	△	△	△	○	○	—	—
	Sodium Silicate	○	○	○	○	△	—	△	△	—	○	○	○
	Sodium Sulfate	○	○	○	○	○	△	△	△	○	○	○	○
	Sodium Sulfide	○	○	○	—	X	△	△	△	—	○	○	○
	Sodium Sulfite	—	X	X	○	○	○	○	△	—	○	—	—
	Sodium Thiosulfate	○	○	○	○	△	—	△	△	○	△	○	○
	Soy Bean Oil	—	○	○	○	△	△	○	○	○	○	—	—
	Stannic Chloride	—	△	○	○	X	X	X	△	○	○	○	○
	Stannous Chloride	○	△	○	—	X	X	X	△	—	○	○	○
	Stearic Acid	○	○	○	○	△	△	△	△	○	△	△	—
	Styrene	△	△	△	○	△	—	△	△	△	X	X	○
	Sulfur	○	○	○	○	X	△	△	—	○	X	○	○

Chemical Resistance Specification Table (for reference)

Test is conducted for saturated solutions of chemicals in the table at a room temperature unless specifically indicated.

	Chemical (weight concentration %, temperature °C)	Tube material				Fitting material				Seal material			
		Polyurethane	Nylon	Polyolefin	Fluorocarbon resin	Brass	SUS304	SUS316	PBT	PP	NBR	EPDM	FKM
S	Sulfur Chloride	—	—	×	○	×	—	△	—	○	△	×	○
	Sulfur Dioxide	×	×	×	○	—	—	△	△	—	△	—	—
	Sulfur Trioxide	×	△	○	○	△	△	△	△	—	—	—	—
	Sulfuric Acid (10%,20°C)	×	△	△	○	×	×	×	△	○	×	○	○
	Sulfuric Acid (10%,70°C)	×	×	△	○	×	×	×	×	○	×	○	○
	Sulfuric Acid (30%,20°C)	×	×	△	○	×	×	×	△	○	×	○	○
	Sulfuric Acid (30%,70°C)	×	×	×	○	×	×	×	×	○	×	○	○
	Sulfuric Acid (98%,20°C)	×	×	×	○	×	×	×	×	×	×	×	○
	Sulfuric Acid (fuming,20°C)	×	×	×	○	×	×	×	×	×	×	×	○
	Sulfurous Acid	×	×	×	○	×	△	△	△	—	△	△	○
T	Table Salt	○	○	○	○	△	△	△	△	○	○	—	○
	Tannic Acid	△	○	○	○	×	△	△	—	○	○	○	○
	Tartaric Acid	○	△	○	○	×	△	△	△	○	○	—	—
	Terpineol	—	○	×	○	—	—	—	—	△	×	—	—
	Tetrachloro Ethane	—	△	×	○	—	—	—	×	×	×	×	○
	Tetraethyl Lead	—	△	△	○	△	—	△	—	—	—	—	—
	Tetrahydro Furan	—	△	×	○	—	—	—	×	×	×	△	×
	Tetraline	—	△	×	○	—	—	—	—	×	×	×	○
	Tetramethyl Lead	○	○	—	○	—	—	—	—	—	—	—	—
	Thionyl Chloride	—	×	×	○	—	—	—	—	×	—	—	○
	Toluene	×	△	×	△	○	○	○	△	×	×	×	△
	Triacetine	—	—	—	○	—	—	—	—	—	△	○	×
	Tributoxyethyl Phosphate	—	○	—	○	—	—	—	○	—	×	—	—
	Tributyl Phosphate	△	○	×	○	○	—	○	○	—	×	—	×
	Trichloroacetic Acid	×	×	△	—	—	△	△	△	—	—	—	—
	Trichloroethylene	×	△	×	○	○	—	○	△	×	×	×	○
	Tricresyl Phosphate	△	○	×	○	—	—	—	○	—	×	○	○
	Triethanolamine	—	○	×	○	—	—	○	△	△	△	△	×
	Tung Oil	—	○	○	○	○	○	○	—	○	○	×	○
	Turpentine Oil	○	○	×	○	△	—	○	△	×	△	△	○
U	Uric Acid	×	○	○	—	—	—	—	△	—	△	○	△
V	Vegetable Oil	—	○	○	○	—	—	—	△	○	○	△	○
X	Xylene	×	△	×	○	—	○	○	○	×	×	×	○
Z	Zeolite	—	○	○	○	—	—	—	△	○	○	○	○
	Zinc Acetate	—	○	○	○	—	—	—	△	○	—	—	—
	Zinc Chloride	○	△	○	○	×	△	○	△	○	○	○	○
	Zinc Sulfide	△	△	○	○	△	△	△	△	○	△	○	△

Tube

Clean tube

Processed tube

PushOne fitting

QuickSeal fitting

Clean fitting/Chemifit

Bamboo-shoot fitting

Control switch/Detachable series

Jig/Tool/Accessory

Technical information

Reference

Index of Product Number

	Product number	Model type	Shape	Page	
1	101	Q.D.C 101 series		160	
	103	Q.D.C 103 series		163	
	1300	Shape-keeping tube (DK tube)		24	
3	330	Chemifit CSA series	Socket	124	
	330	Chemifit CS series	Socket	132	
	3A0	Chemifit CSA series	Bushing	124	
	3A0	Chemifit CS series	Bushing	132	
4	4A01	QuickSeal series Insertless type	Connector	95	
	4A02	QuickSeal series Insertless type	90 degree elbow	95	
	4A03	QuickSeal series Insertless type	Tee	95	
	4A04	QuickSeal series Insertless type	Service tee	96	
	4A05	QuickSeal series Insertless type	Union tee	96	
	4A06	QuickSeal series Insertless type	Swivel nut internal connector	96	
	4A07	QuickSeal series Insertless type	Union connector	97	
	4A08	QuickSeal series Insertless type	90 degree union elbow	97	
A	A45L	PushOne A series	45 degree elbow	40	
	AAL	PushOne A series	Adapter elbow	47	
	AC	PushOne A series	Connector	38	
	AC★-★A	PushOne A series	Hexagonal socket round connector	38	
	ACC	PushOne A series	Tube cap	49	
	AFC	PushOne A series	Internal connector	38	
	AFL	PushOne A series	90 degree internal elbow	39	
	AL	PushOne A series	90 degree elbow	39	
	ALB	PushOne A series	Universal elbow	41	
	ALL	PushOne A series	90 degree long elbow	40	
	ALTB	PushOne A series	Triple universal elbow	42	
	ALWB	PushOne A series	Double universal elbow	42	
	ALY	PushOne A series	90 degree branch elbow	41	
	ALYB	PushOne A series	Universal branch elbow	42	
	AMA	PushOne A series	Manifold A type	48	
	AMB	PushOne A series	Manifold B type	48	
	APC	PushOne A series	Panel touch connector	46	
	APFC	PushOne A series	Internal panel touch connector	46	
	APL	PushOne A series	90 degree panel touch elbow	47	
	AR	PushOne A series	Reducer	47	
	ASC	Compact speed controller	Elbow type	145	
	AST	PushOne A series	Service tee	43	
	AT	PushOne A series	Tee	43	
	AUC	PushOne A series	Union connector	44	
	AUL	PushOne A series	90 degree union elbow	44	
	AULY	PushOne A series	90 degree branch union elbow	45	
	AUT	PushOne A series	Union tee	45	
	AUWY	PushOne A series	Double Y union	46	
	AY	PushOne A series	Y joint	44	
	AYA	PushOne A series	Y plug	48	
	AYB	PushOne A series	Y union	45	
	B	BAB	Bamboo-shoot series Barb type	Adapter bush	141
BAN		Bamboo-shoot series Barb type	Adapter union nipple	141	
BBP		Bamboo-shoot series Barb type	Plug	141	
BC		PushOne A series	Blank plug	49	
BC		PushOne E series	Blank plug	65	
BC		PushOne E series Mini type	Blank plug	71	
BC		PushOne E series Brass body type	Blank plug	75	
BC★-C1		Chemifit C1 series	Blank plug	111	
BL		Bamboo-shoot series Barb type	Elbow (block)	141	
BN		Bamboo-shoot series Barb type	Connector	141	
BRK		Speed controller	Bracket	150	
BRK		Throttle valve	Bracket	155	
BSN		Bamboo-shoot series Barb type	Connector (integrated type)	141	
BT		Bamboo-shoot series Barb type	Tee (block)	141	
BUVL		Bamboo-shoot series Barb type	Universal elbow (block)	141	
BUVT		Bamboo-shoot series Barb type	Universal tee (block)	141	
C		C1N	QuickSeal series Insertion type (brass)	Connector (group 1)	78
		C1N★-S	QuickSeal series Insertion type (stainless)	Connector (group 1)	90
		C2N	QuickSeal series Insertion type (brass)	Connector (group 2)	78
		C4N	QuickSeal series Insertion type (brass)	Connector (group 4)	78
	C4N★-S	QuickSeal series Insertion type (stainless)	Connector (group 4)	90	
	CP	Spatter cap		169	
	CP-C★	Chemifit CP series	Connector	136	
	CPFW	Spatter cap		169	
CPI	Chemifit CP series	Insertion part	139		

	Product number	Model type	Shape	Page	
C	CP-L★	Chemifit CP series	90 degree elbow	136	
	CPN	Chemifit CP series	Nut	139	
	CPP	Spatter cap		169	
	CPS	Chemifit CP series	Sleeve	139	
	CP-ST★	Chemifit CP series	Service tee	137	
	CP-T★	Chemifit CP series	Tee	137	
	CP-UC★	Chemifit CP series	Union connector	138	
	CP-UL★	Chemifit CP series	90 degree union elbow	138	
	CP-UT★	Chemifit CP series	Union tee	138	
	CSA-C★	Chemifit CSA series	Connector	120	
	CSA-FC★	Chemifit CSA series	Internal connector	120	
	CSA-L★	Chemifit CSA series	90 degree elbow	121	
	CSAN	Chemifit CSA series	Assembly nut	123	
	CSA-ST★	Chemifit CSA series	Service tee	122	
	CSA-T★	Chemifit CSA series	Tee	121	
	CSA-UC★	Chemifit CSA series	Union connector	122	
	CSA-UCT★	Chemifit CSA series	Panel touch connector	123	
	CSA-UL★	Chemifit CSA series	90 degree union elbow	122	
	CSA-UT★	Chemifit CSA series	Union tee	123	
	CS-C★	Chemifit CS series	Connector	128	
	CS-FC★	Chemifit CS series	Internal connector	128	
	CS-L★	Chemifit CS series	90 degree elbow	129	
	CSN	Chemifit CS series	Nut	131	
	CSS	Chemifit CS series	Sleeve	132	
	CS-ST★	Chemifit CS series	Service tee	130	
	CS-T★	Chemifit CS series	Tee	129	
	CS-UC★	Chemifit CS series	Union connector	130	
	CS-UCT★	Chemifit CS series	Panel touch connector	131	
	CS-UL★	Chemifit CS series	90 degree union elbow	130	
	CS-UT★	Chemifit CS series	Union tee	131	
	D	DC	QuickSeal series DK tube dedicated type	Connector	99
		DL	QuickSeal series DK tube dedicated type	90 degree elbow	99
		DT	QuickSeal series DK tube dedicated type	Tee	99
		DUP	QuickSeal series DK tube dedicated type	Copper-pipe connection panel touch connector	101
DUT		QuickSeal series DK tube dedicated type	Panel touch connector	100	
E	E45L	PushOne E series	45 degree elbow	55	
	EAL	PushOne E series	Adapter elbow	63	
	EC	PushOne E series	Connector	52	
	EC★-★A	PushOne E series	Hexagonal socket round connector	52	
	EC★-★A-M	PushOne E series Mini type	Hexagonal socket round connector	68	
	EC★-C1	Chemifit C1 series	Connector	106	
	EC★-C1S	Chemifit C1S series	Connector	114	
	EC★-M	PushOne E series Mini type	Connector	68	
	ECC	PushOne E series	Tube cap	65	
	ECV	Valve built-in connector		159	
	EFC	PushOne E series	Internal connector	53	
	EFL	PushOne E series	90 degree internal elbow	54	
	EFC★-C1S	Chemifit C1S series	Internal connector	114	
	EL	PushOne E series	90 degree elbow	53	
	EL★-C1	Chemifit C1 series	90 degree elbow	107	
	EL★-C1S	Chemifit C1S series	90 degree elbow	114	
	EL★-M	PushOne E series Mini type	90 degree elbow	68	
	ELB	PushOne E series	Universal elbow	55	
	ELL	PushOne E series	90 degree long elbow	54	
	ELL★-M	PushOne E series Mini type	90 degree long elbow	69	
	ELTB	PushOne E series	Triple universal elbow	57	
	ELWB	PushOne E series	Double universal elbow	56	
	ELY	PushOne E series	90 degree branch elbow	56	
	ELYB	PushOne E series	Universal branch elbow	56	
	EMA	PushOne E series	Manifold A type	64	
	EMA★-C1	Chemifit C1 series	Manifold	111	
	EMB	PushOne E series	Manifold B type	64	
	EMVA	Miniature valve (PushOne)	Inline type	157	
	EMVB	Miniature valve (PushOne)	Straight type	157	
	EMVC	Miniature valve (PushOne)	Angled type	157	
	EN	PushOne A series	Nipple	49	
EN	PushOne E series	Nipple	65		
EN	PushOne E series Mini type	Nipple	71		
EN	PushOne E series Brass body type	Nipple	75		
ENC	Throttle valve	Elbow type	155		
ENU	Throttle valve	Inline type	155		

Tube

Clean tube

Processed tube

PushOne fitting

QuickSeal fitting

Clean fitting/Chemifit

Bamboo-shoot fitting

Control switch/Detachable series

Jig/Tool/Accessory

Technical information

Reference

	Product number	Model type	Shape	Page
E	EOT	Off tool		169
	EPC	PushOne E series	Panel touch connector	62
	EPC★-C1	Chemifit C1 series	Panel touch connector	110
	EPC★-C1S	Chemifit C1S series	Panel touch connector	116
	EPFC	PushOne E series	Internal panel touch connector	62
	EPL	PushOne E series	90 degree panel touch elbow	63
	ER	PushOne E series	Reducer	63
	ER★-C1	Chemifit C1 series	Reducer	111
	ESC	Speed controller	Elbow type	149
	ESC★-C1SG	Chemifit C1 speed controller	Elbow type	147
	ESD	Speed controller	Universal type	149
	EST	PushOne E series	Service tee	58
	EST★-C1	Chemifit C1 series	Service tee	108
	EST★-C1S	Chemifit C1S series	Service tee	115
	EST★-M	PushOne E series Mini type	Service tee	69
	ESU	Speed controller	Inline type	150
	ESU★-C1SG	Chemifit C1 speed controller	Inline type	147
	ET	PushOne E series	Tee	57
	ET★-C1	Chemifit C1 series	Tee	107
	ET★-C1S	Chemifit C1S series	Tee	115
	ET★-M	PushOne E series Mini type	Tee	69
	ETC★-C1	Chemifit C1 series	Through connector	106
	EUC	PushOne E series	Union connector	59
	EUC★-C1	Chemifit C1 series	Union connector	109
	EUC★-M	PushOne E series Mini type	Union connector	70
	EUL	PushOne E series	90 degree union elbow	60
	EUL★-C1	Chemifit C1 series	90 degree union elbow	109
	EUL★-M	PushOne E series Mini type	90 degree union elbow	70
	EULY	PushOne E series	90 degree branch union elbow	60
	EUT	PushOne E series	Union tee	61
	EUT★-C1	Chemifit C1 series	Union tee	110
	EUT★-M	PushOne E series Mini type	Union tee	71
EUWY	PushOne E series	Double Y union	62	
EY	PushOne E series	Y joint	59	
EY★-C1	Chemifit C1 series	Y joint	108	
EY★-C1S	Chemifit C1S series	Y joint	116	
EY★-M	PushOne E series Mini type	Y joint	70	
EYA	PushOne E series	Y plug	64	
EYB	PushOne E series	Y union	61	
EYB★-C1	Chemifit C1 series	Y union	110	
EYB★-M	PushOne E series Mini type	Y union	71	
F	FC1N	QuickSeal series Insertion type (brass)	Internal connector (group 1)	82
	FC4N	QuickSeal series Insertion type (brass)	Internal connector (group 4)	82
	FS	Flame-resistant tube		20
	FW	Flame-resistant tube		21
	FWU	Flame-resistant tube		22
H	HPN	Speed controller	Connector pin	150
	HPN	Throttle valve	Connector pin	155
	HPN★-C1	Chemifit C1 speed controller	Connector pin	147
L	L1N	QuickSeal series Insertion type (brass)	90 degree elbow (group 1)	79
	L1N★-S	QuickSeal series Insertion type (stainless)	90 degree elbow (group 1)	90
	L2N	QuickSeal series Insertion type (brass)	90 degree elbow (group 2)	79
	L4N	QuickSeal series Insertion type (brass)	90 degree elbow (group 4)	79
	L4N★-S	QuickSeal series Insertion type (stainless)	90 degree elbow (group 4)	90
M	MEL	PushOne E series Brass body type	90 degree elbow	74
	MEST	PushOne E series Brass body type	Service tee	74
	MET	PushOne E series Brass body type	Tee	74
	MEUC	PushOne E series Brass body type	Union connector	75
	MEUL	PushOne E series Brass body type	90 degree union elbow	75
	MEUT	PushOne E series Brass body type	Union tee	75
	MRG	Bamboo-shoot series Barb type	Gasket	141
	MSN	QuickSeal series Insertion type (brass)	Brass sleeve	85
	MSN	QuickSeal series Insertless type	Brass sleeve	97
	N	N	QuickSeal series Insertion type (brass)	Brass nut
N		QuickSeal series Insertless type	Brass nut	97
N		QuickSeal series DK tube dedicated type	Brass nut	101
N★-S		QuickSeal series Insertion type (stainless)	Stainless nut	93
N1		Nylon tube		17
N2		Nylon tube		15
N5		Nylon tube		16
P	PB	Polybutene tube		25

	Product number	Model type	Shape	Page	
P	PL	Polyolefine resin tube		26	
	PN	Polyolefine resin tube		27	
	PTR	Tube reel		169	
Q	QMVA	Miniature valve (QuickSeal)	Inline type	158	
	QMVB	Miniature valve (QuickSeal)	Straight type	158	
	QMVC	Miniature valve (QuickSeal)	Angled type	158	
S	S	Nylon coil tube		32	
	S★-ES★	QuickSeal series Nylon coil tube dedicated type	ES swivel nut internal connector	103	
	S★-FS★	QuickSeal series Nylon coil tube dedicated type	FS swivel nut internal connector	103	
	S★-M★	QuickSeal series Nylon coil tube dedicated type	Connector	102	
	S101	Q.D.C. 101 series (SUS304)		160	
	SBRK	Chemifit C1 speed controller	Bracket	147	
	SC1N	QuickSeal series Insertion type (brass)	Swivel nut internal connector (group 1)	84	
	SC2N	QuickSeal series Insertion type (brass)	Swivel nut internal connector (group 2)	84	
	SC4N	QuickSeal series Insertion type (brass)	Swivel nut internal connector (group 4)	84	
	SI	QuickSeal series Nylon coil tube dedicated type	Insertion part for S 3/4	103	
	SN	QuickSeal series DK tube dedicated type	Brass sleeve	101	
	SN	QuickSeal series Insertion type (brass)	Nylon sleeve	85	
	SN	QuickSeal series Insertion type (stainless)	Nylon sleeve	93	
	SS	QuickSeal series Nylon coil tube dedicated type	Nylon sleeve	103	
	ST1N	QuickSeal series Insertion type (brass)	Service tee (group 1)	81	
	ST1N★-S	QuickSeal series Insertion type (stainless)	Service tee (group 1)	91	
	ST2N	QuickSeal series Insertion type (brass)	Service tee (group 2)	81	
	ST4N	QuickSeal series Insertion type (brass)	Service tee (group 4)	81	
	ST4N★-S	QuickSeal series Insertion type (stainless)	Service tee (group 4)	91	
	T	T1N	QuickSeal series Insertion type (brass)	Tee (group 1)	80
		T1N★-S	QuickSeal series Insertion type (stainless)	Tee (group 1)	91
		T2N	QuickSeal series Insertion type (brass)	Tee (group 2)	80
		T4N	QuickSeal series Insertion type (brass)	Tee (group 4)	80
T4N★-S		QuickSeal series Insertion type (stainless)	Tee (group 4)	91	
TA		Fluorocarbon resin tube		28	
TC01		Tube cutter		167	
TC02		FW tube outer cover peeling cutter		168	
TC02U		FWU tube outer cover peeling cutter		168	
TC03		FW tube outer cover peeling cutter		168	
TC03U	FWU tube outer cover peeling cutter		168		
TC04	Tube cutter		167		
TES	Flexible fluorocarbon resin tube		18		
TP	Fluorocarbon resin tube		29		
U	U1	Polyurethane tube		13	
	U2	Polyurethane tube		12	
	U5	Polyurethane tube		14	
	UC	Polyurethane coil tube		30	
	UC1N	QuickSeal series Insertion type (brass)	Union connector (group 1)	82	
	UC1N★-S	QuickSeal series Insertion type (stainless)	Union connector (group 1)	92	
	UC4N	QuickSeal series Insertion type (brass)	Union connector (group 4)	82	
	UC4N★-S	QuickSeal series Insertion type (stainless)	Union connector (group 4)	92	
	UCT1N	QuickSeal series Insertion type (brass)	Panel touch connector (group 1)	84	
	UCT4N	QuickSeal series Insertion type (brass)	Panel touch connector (group 4)	84	
	UDC	QuickSeal series DK tube dedicated type	Union connector	100	
	UDT	QuickSeal series DK tube dedicated type	Union tee	100	
	UE	Anti-static tube		23	
	UL1N	QuickSeal series Insertion type (brass)	90 degree union elbow (group 1)	83	
	UL4N	QuickSeal series Insertion type (brass)	90 degree union elbow (group 4)	83	
	UL4N★-S	QuickSeal series Insertion type (stainless)	90 degree union elbow (group 4)	92	
	UMC	Polyurethane multi-coil tube		30	
	UML	Polyurethane multi-line tube		31	
	USC	Polyurethane coil tube		30	
	UT1N	QuickSeal series Insertion type (brass)	Union tee (group 1)	83	
	UT1N★-S	QuickSeal series Insertion type (stainless)	Union tee (group 1)	92	
UT2N	QuickSeal series Insertion type (brass)	Union tee (group 2)	83		
UT4N	QuickSeal series Insertion type (brass)	Union tee (group 4)	83		
UT4N★-S	QuickSeal series Insertion type (stainless)	Union tee (group 4)	92		
V	VA	Ball valve	Angled type	153	
	VS	Ball valve	Straight type	152	

Tube

Clean tube

Processed tube

PushOne fitting

QuickSeal fitting

Clean fitting/Chemifit

Bamboo-shoot fitting

Control switch/Detachable series

Jig/Tool/Accessory

Technical information

Reference

